CDI2H20WPZX Stainless Steel Speed Dome Camera

User Manual

Please read this manual thoroughly before use and keep it handy for future reference.

WARNING

TO REDUCE THE RISK OF FIRE OR ELECTRIC SHOCK, DO NOT EXPOSE THIS PRODUCT TO RAIN OR MOISTURE. DO NOT INSERT ANY METALLIC OBJECTS THROUGH THE VENTILATION GRILLS OR OTHER OPENINGS ON THE EQUIPMENT.

CAUTION

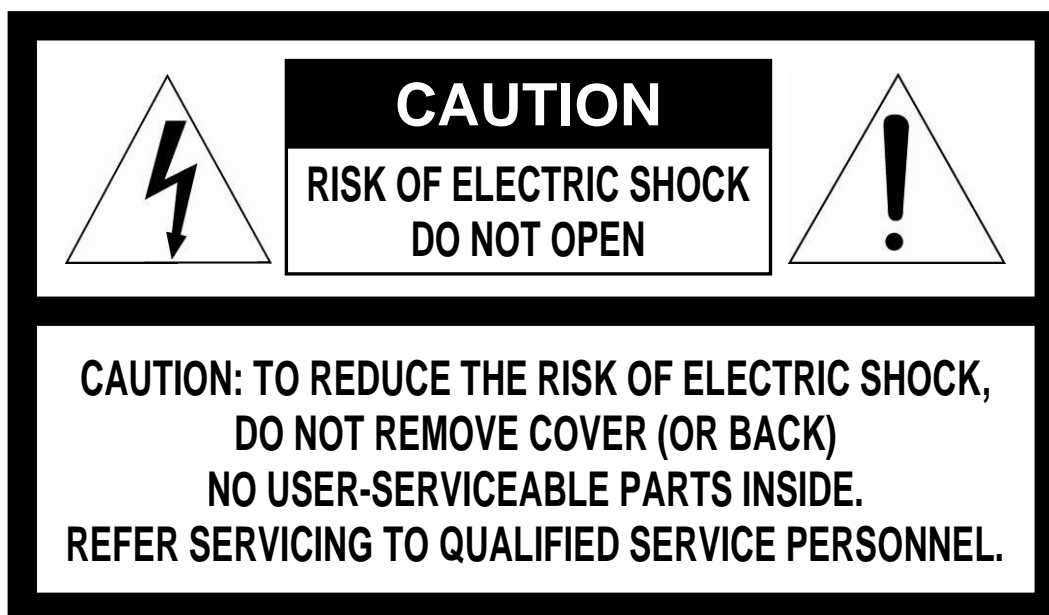

EXPLANATION OF GRAPHICAL SYMBOLS

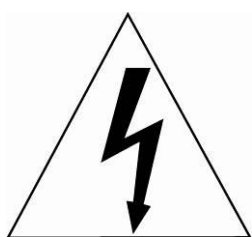

The lightning flash with arrowhead symbol, within an equilateral triangle, is intended to alert the user to the presence of uninsulated “dangerous voltage” within the product’s enclosure that may be of sufficient magnitude to constitute a risk of electric shock to persons.



The exclamation point within an equilateral triangle is intended to alert the user to the presence of important operating and maintenance (servicing) instructions in the literature accompanying the appliance.

FCC COMPLIANCE STATEMENT

This device complies with Part 15 of the FCC Rules. Operation is subject to the following two conditions: (1) this device may not cause harmful interference, and (2) this device must accept any interference received, including interference that may cause undesired operation.

FCC INFORMATION: This equipment has been tested and found to comply with the limits for a Class A digital device, pursuant to Part 15 of the FCC Rules. These limits are designed to provide reasonable protection against harmful interference when the equipment is operated in a commercial environment. This equipment generates, uses, and can radiate radio frequency energy and, if not installed and used in accordance with the instruction manual, may cause harmful interference to radio communications. Operation of this equipment in a residential area is likely to cause harmful interference in which case the user will be required to correct the interference at his own expense.

CAUTION: Changes or modifications not expressly approved by the party responsible for compliance could void the user's authority to operate the equipment.

This Class A digital apparatus complies with Canadian ICES-003.

Cet appareil numérique de la classe A est conforme à la norme NMB-003 du Canada.

CE COMPLIANCE STATEMENT

WARNING

This is a Class A product. In a domestic environment this product may cause radio interference in which case the user may be required to take adequate measures.

CAUTION

RISK OF EXPLOSION IF BATTERY IS REPLACED
BY AN INCORRECT TYPE.
DISPOSE OF USED BATTERIES ACCORDING
TO THE INSTRUCTIONS.

IMPORTANT SAFETY INSTRUCTIONS

1. Read these instructions.
2. Keep these instructions.
3. Heed all warnings.
4. Follow all instructions.
5. Do not use this apparatus near water.
6. Clean only with dry cloth.
7. Do not block any ventilation openings. Install in accordance with the manufacturer's instructions.
8. Do not install near any heat sources such as radiators, heat registers, stoves, or other apparatus (including amplifiers) that produce heat.
9. Do not defeat the safety purpose of the polarized or grounding-type plug. A polarized plug has two blades with one wider than the other. A grounding type plug has two blades and a third grounding prong. The wide blade or the third prong is provided for your safety. If the provided plug does not fit into your outlet, consult an electrician for replacement of the obsolete outlet.
10. Protect the power cord from being walked on or pinched particularly at plugs, convenience receptacles, and the point where they exit from the apparatus.
11. Only use attachments/accessories specified by the manufacturer.
12. Use only with the cart, stand, tripod, bracket, or table specified by the manufacturer, or sold with the apparatus. When a cart is used, use caution when moving the cart/apparatus combination to avoid injury from tip-over.
13. Unplug this apparatus during lightning storms or when unused for long periods of time.
14. Refer all servicing to qualified service personnel. Servicing is required when the apparatus has been damaged in any way, such as power-supply cord or plug is damaged, liquid has been spilled or objects have fallen into the apparatus, the apparatus has been exposed to rain or moisture, does not operate normally, or has been dropped.
15. **CAUTION – THESE SERVICING INSTRUCTIONS ARE FOR USE BY QUALIFIED SERVICE PERSONNEL ONLY. TO REDUCE THE RISK OF ELECTRIC SHOCK DO NOT PERFORM ANY SERVICING OTHER THAN THAT CONTAINED IN THE OPERATING INSTRUCTIONS UNLESS YOU ARE QUALIFIED TO DO SO.**
16. **Use satisfy clause 2.5 of IEC60950-1/UL60950-1 or Certified/Listed Class 2 power source only.**
17. ITE is to be connected only to PoE networks without routing to the outside plant.



Contents

1 Introduction	I
1.1 Components.....	I
1.2 Key Features	II
2 Installations	III
2.1 Housing Assembly	III
2.1.1 Bubble Cover Assembly.....	III
.....	III
2.1.2 Cable Grand Assembly.....	III
.....	IV
2.2 Camera Module Assembly	IV
2.2.1 Camera Sub Board Assembly.....	IV
2.2.2 Camera Main Board Assembly	IV
.....	V
2.2.3 SD Card Board Assembly.....	V
.....	V
2.2.4 Camera Module Bracket Assembly	VI
.....	VI
2.3 Camera Cable Connection	VI
2.4 Basic Configuration of Camera System	VI
2.5 Connections.....	VIII
2.4 Network Connection & IP assignment	IX
3 Operation	X
3.1 Access from a browser	X
3.2 Access from the internet.....	XI
3.3 Setting the admin password over a secure connection.....	XI
3.4 Live View Page.....	XII
3.5 Playback.....	XIV
3.6 Network Camera Setup.....	XVI
3.6.1 Basic Configuration.....	XVI
3.6.2 Live View	XX
3.6.3 Video & Image.....	XXI
3.6.4 Audio	XXIX
3.6.5 Event	XXX
3.6.6 Configuration (TBD)	LV
3.6.7 System	LX
3.7 Help.....	LXXX
3.8 Resetting to the factory default settings.....	LXXXI

A Appendix	LXXXII
A.1 Troubleshooting	LXXXII
A.2 Alarm Connection	LXXXIII
A.3 Preventive Maintenance	LXXXIII
A.4 Product Specification	LXXXIV
A.5 System Requirement for Web Browser	LXXXVI
A.6 General Performance Considerations	LXXXVI

1 Introduction

The network camera supports the network service for a sensor image with progressive scan, which can be monitored on a real-time screen regardless of distances and locations. By using its dedicated program, many users are able to have an access to the network camera at once or a single user can monitor various network cameras at the same time. It also enables users to play, store and retrieve a monitoring image by using a PC. All the settings and real-time monitoring screens are also provided through an access to the web.

The network camera is fully featured for security surveillance and remote monitoring needs. It is based on the DSP compression chip, and makes it available on the network as real-time, full frame rate Motion JPEG and H.264 video streams.

1.1 Components

The camera is designed with compact, small size, hard dome camera housing. The housing is constructed of aluminum, steel and plastic. The housing is designed to be mounted on a wall or a ceiling. The housing meets the Protection Classification IP66 standards for dust and moisture resistance.

* Dome Camera	1
* Accessory Connector	1
1) 2-Pin Terminal Block	(1)
2) 3-Pin Terminal Block	(1)
3) 4-Pin Terminal Block	(1)
4) 5-Pin Terminal Block	(1)

1.2 Key Features

- **Brilliant video quality**

The network camera offers the highly efficient H.264 video compression, which drastically reduces bandwidth and storage requirements without compromising image quality. Motion JPEG is also supported for increased flexibility.

- **Dual or Triple Streams**

The network camera can deliver dual or triple video streams simultaneously at full frame rate in all resolutions up to Full-HD (1920 x 1080p) using Motion H.264 and JPEG. This means that several video streams can be configured with different compression formats, resolutions and frame rates for different needs.

- **Image setting adjustment**

The network camera also enables users to adjust image settings such as contrast, brightness and saturation to improve images before encoding takes place.

- **Intelligent video capabilities**

The network camera includes intelligent capabilities such as VCA (Video Content Analysis). The network camera's external inputs and outputs can be connected to devices such as sensors and relays, enabling the system to react to alarms and activate lights or open/close doors.

- **Improved Security**

The network camera logs all user access, and lists currently connected users. Also, its full frame rate video can be provided over HTTPS.

- **PoE (Power over Ethernet)**

This network camera can be powered through PoE, which simplifies installation since only one cable is needed for carrying power, as well as video controls.

- **ONVIF Certificate**

This is a global interface standard that makes it easier for end users, integrators, consultants, and manufacturers to take advantage of the possibilities offered by network video technology. ONVIF enables interoperability between different vendor products, increased flexibility, reduced cost, and future-proof systems.

- **Micro-SD Recording support**

The network camera also supports a Micro-SD memory slot for local recording with removable storage.

- **Audio support**

The network camera also supports two-way audio.

2 Installations

2.1 Housing Assembly

2.1.1 Bubble Cover Assembly

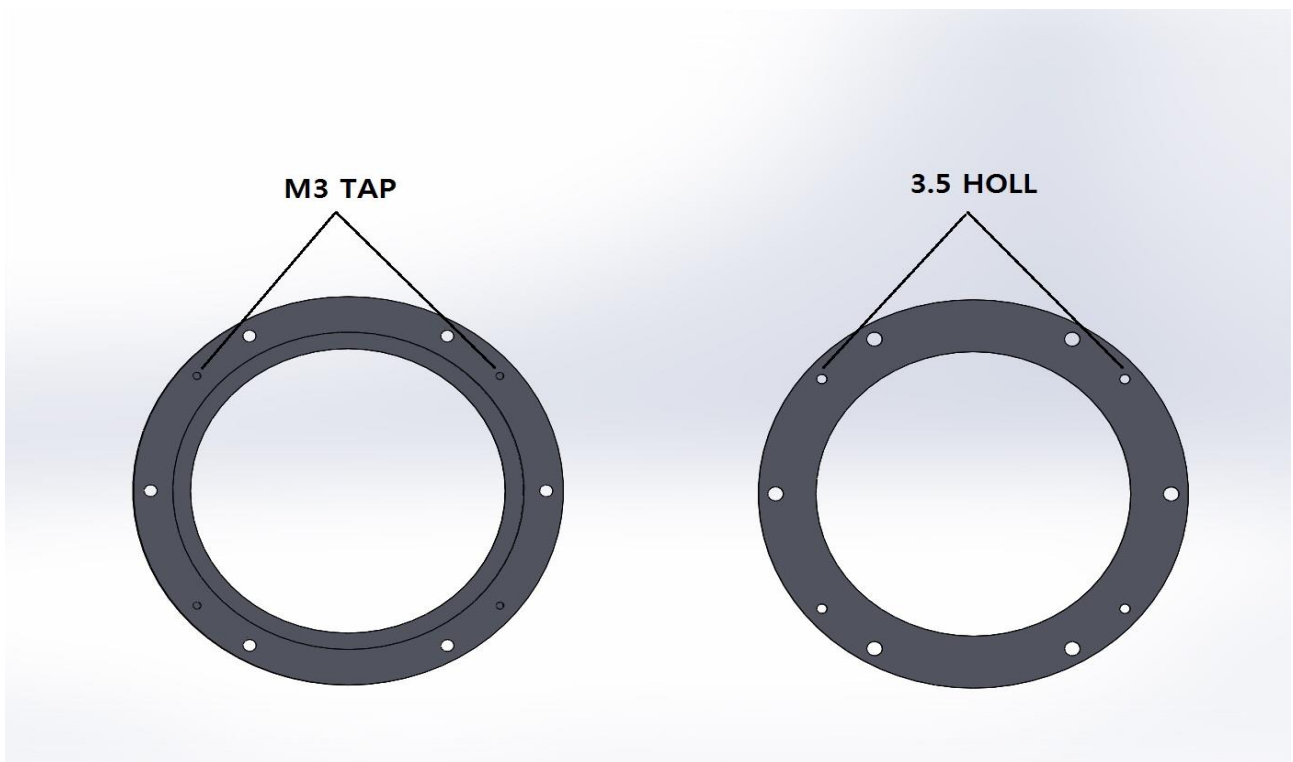
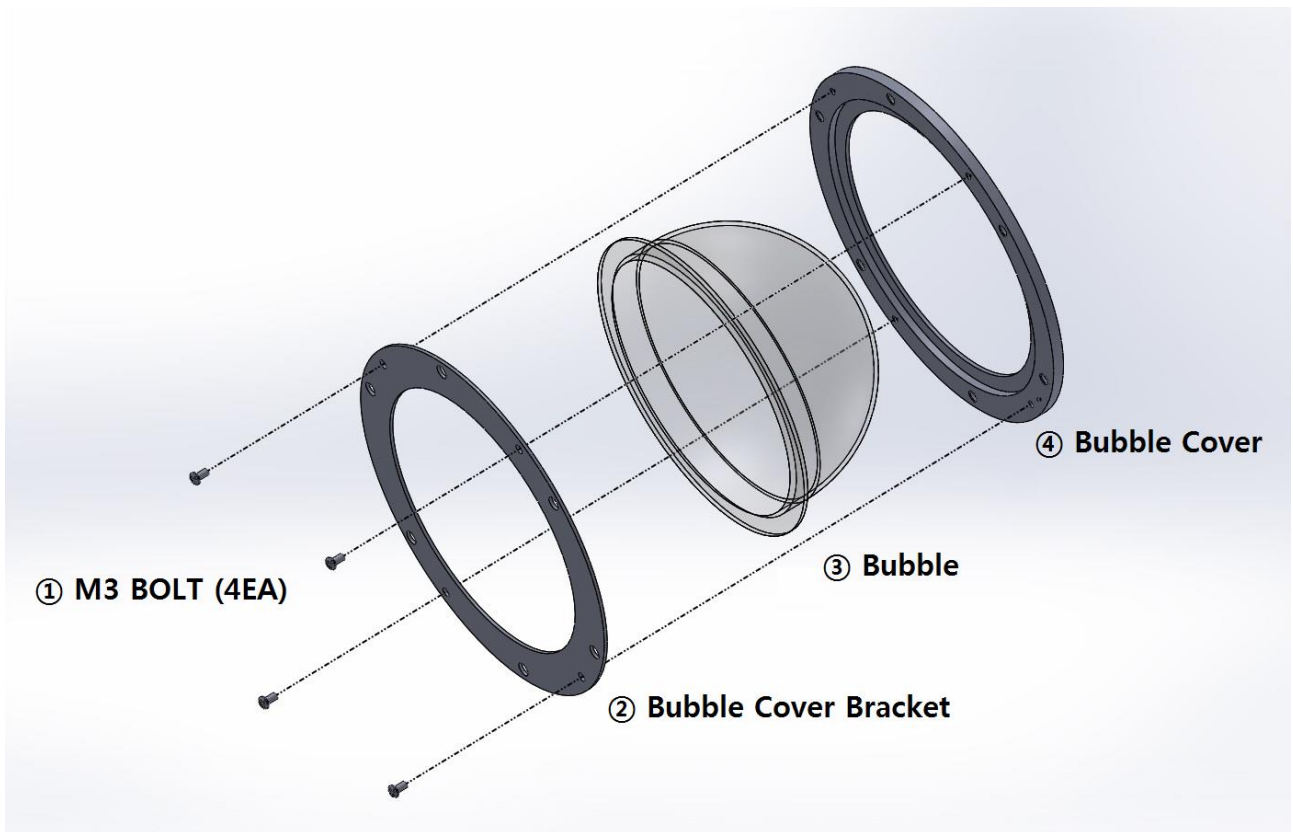

2.1.2 Cable Grand Assembly

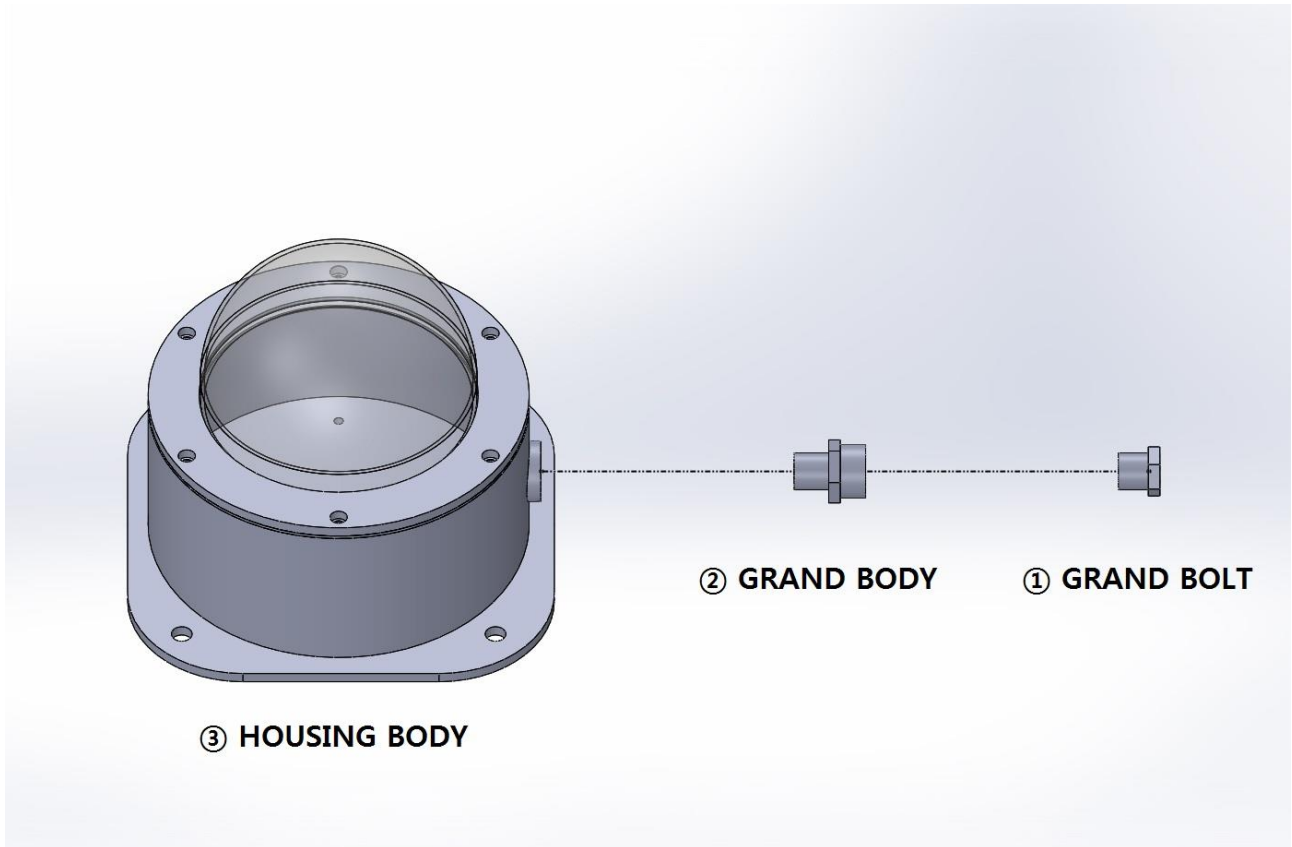

2.2 Camera Module Assembly

2.2.1 Camera Sub Board Assembly

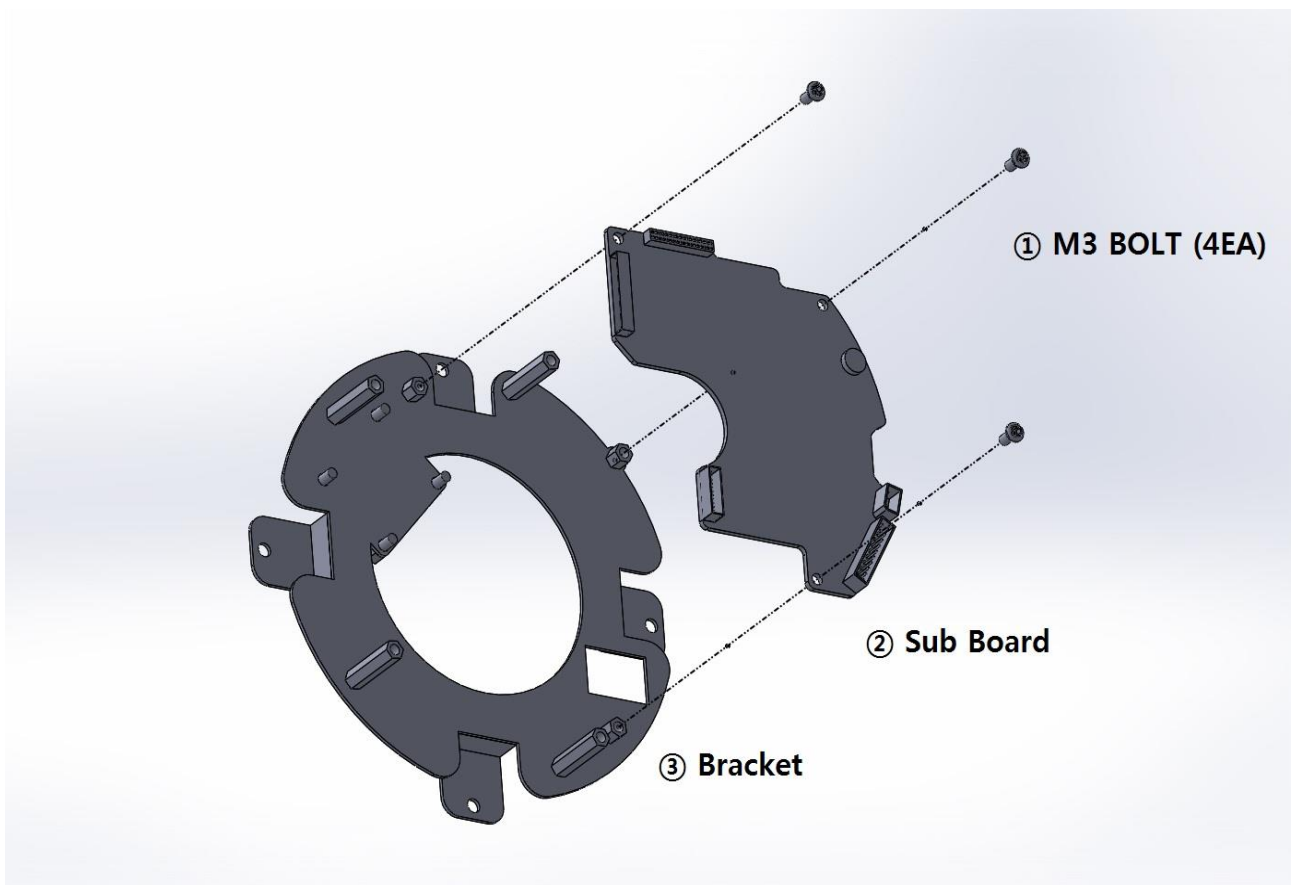

2.2.2 Camera Main Board Assembly

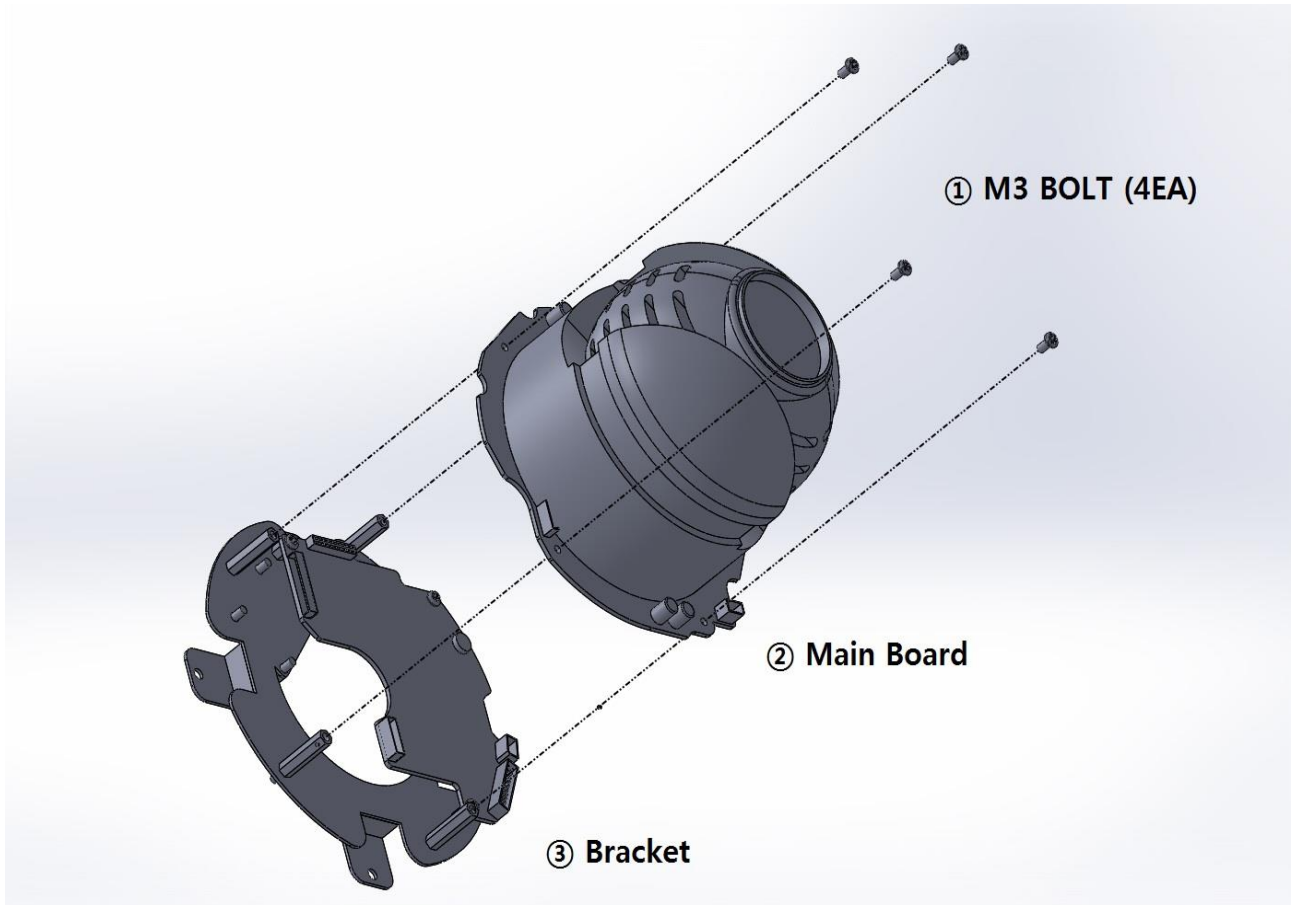

2.2.3 SD Card Board Assembly

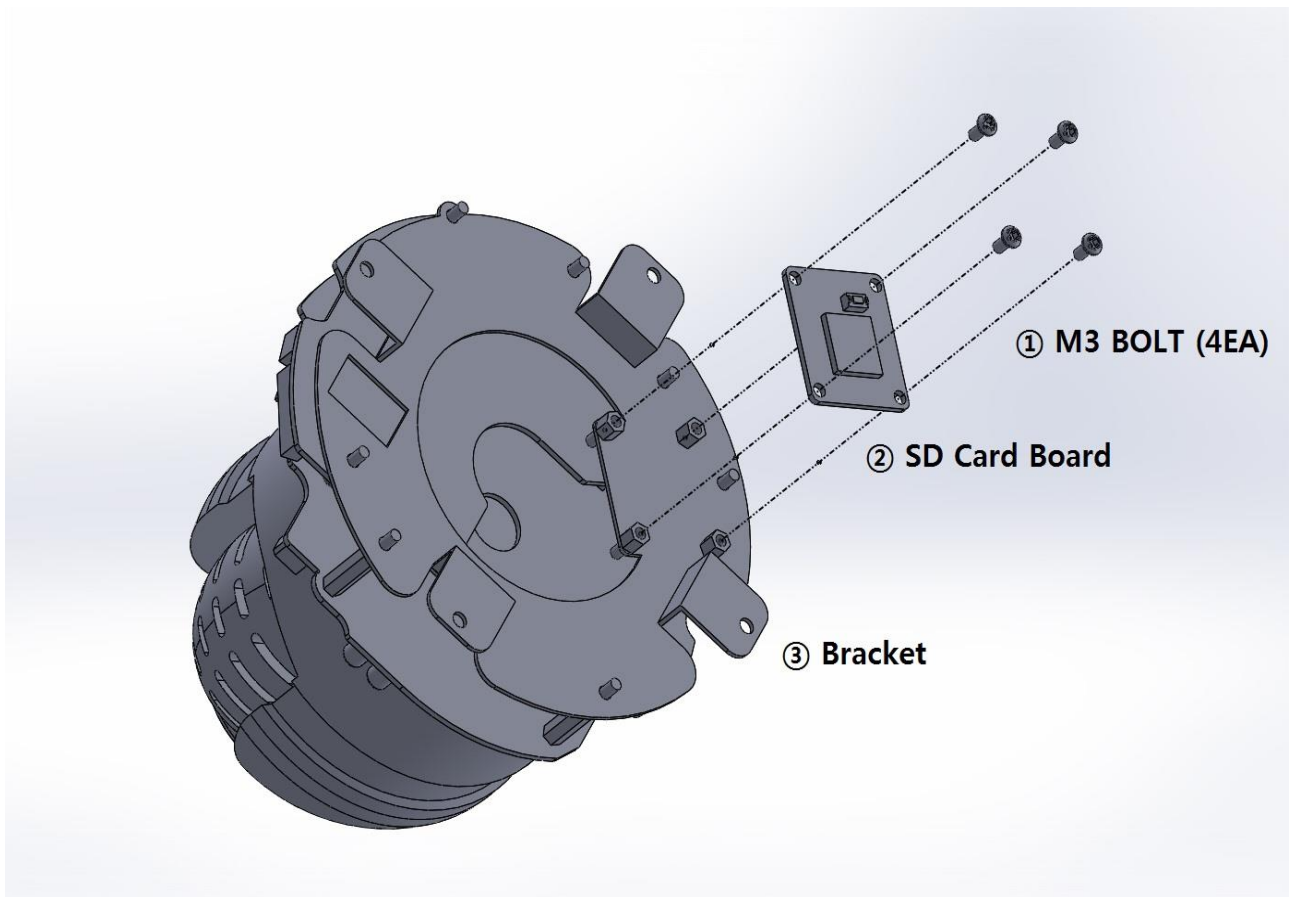

2.2.4 Camera Module Bracket Assembly

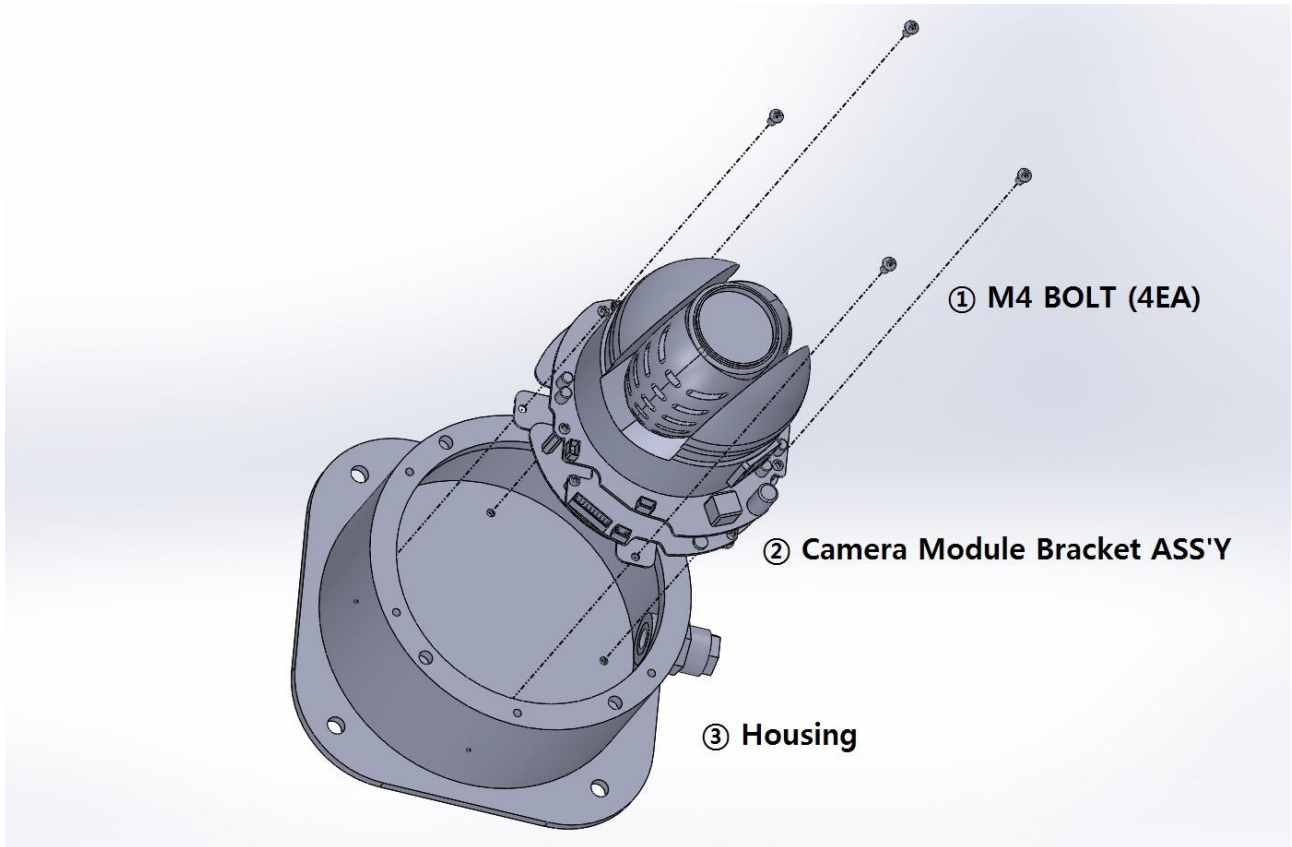

2.3 Camera Cable Connection

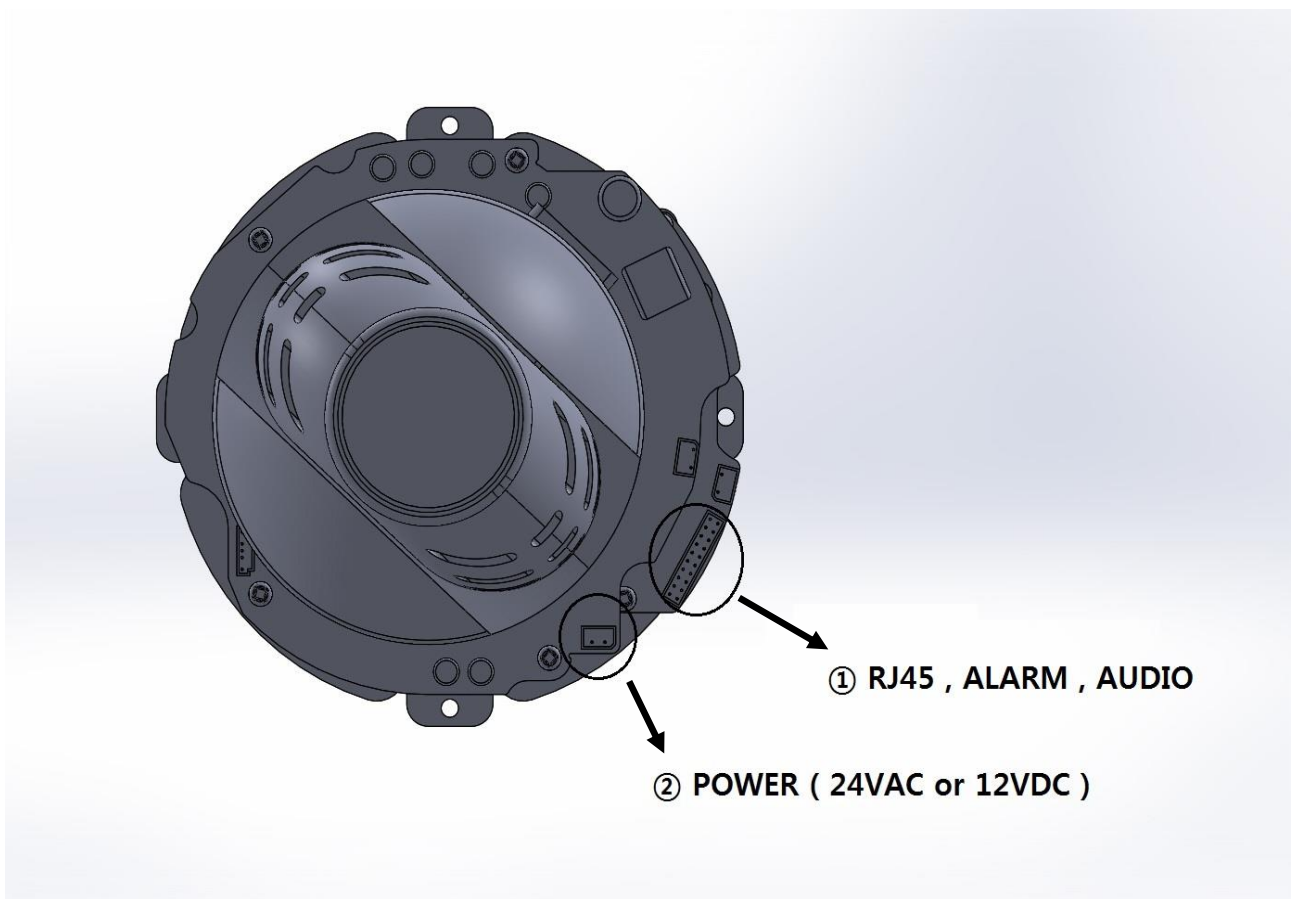

2.4 Basic Configuration of Camera System

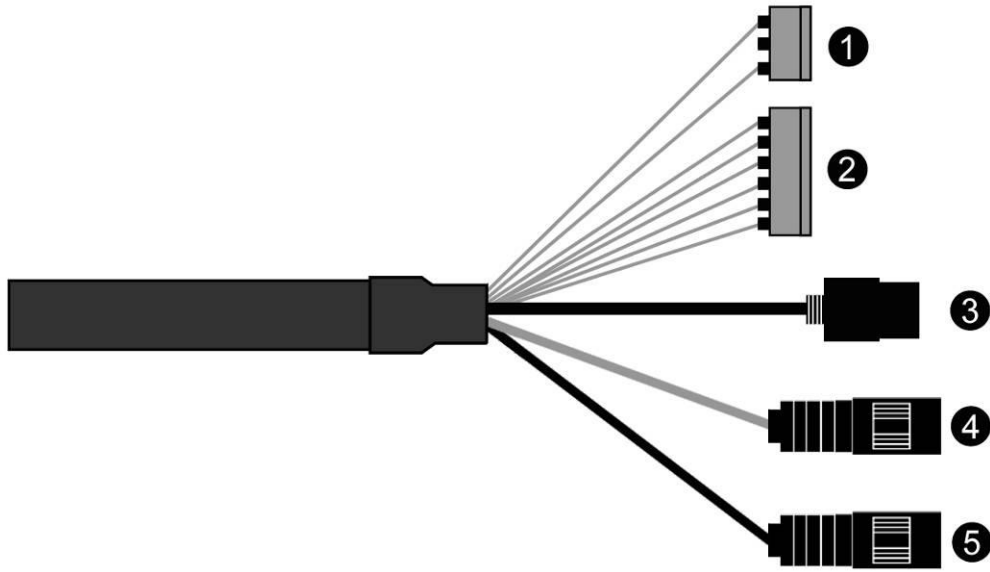

No.	Connector	Wire Color	Description
1	3-pin terminal block	RED	24VAC or 12VDC+
		WHITE	24VAC or 12VDC-
2	6-pin terminal block	PINK	ALARM INPUT 1
		GRAY	ALARM INPUT 2
		GREEN	ALARM INPUT 3
		BLUE	ALARM INPUT 4
		BROWN	GND
		YELLOW	ALARM OUTPUT
3	RJ-45	BLACK	Ethernet, RJ-45 port compatible with 10/100Mbps having PoE functionality
4	STEREO jack	GRAY	AUDIO OUTPUT
5	STEREO jack	BLACK	AUDIO INPUT

The camera must be installed by qualified service personnel in accordance with all local and federal electrical and building codes.

2.5 Connections

- **Connecting the Network**

Connect a standard RJ-45 cable to the network port of the camera. Generally, a crossover cable is used for directly connection to PC, while a direct cable is used for connection to a hub.

- **Connecting Audio**

Connect speaker to audio output line and external mic to audio input line.

- **Connecting Alarms**

- **A1, A2, A3, A4 (Alarm Input 1,2,3,4)**

You can use external devices to signal the camera to react on events. Mechanical or electrical switches can be wired to the A1, A2, A3, A4 (Alarm Input 1,2,3,4) and G (Ground) connectors.

- **G (Ground)**

NOTE: All the connectors marked G or GND are common.

Connect the ground side of the alarm input and/or alarm output to the G (Ground)connector.

- **AO (Alarm Output)**

The camera can activate external devices such as buzzers or lights. Connect the device to the AO (Alarm Output) and G (Ground) connectors.

- **Connecting the Power**

Connect power of 12VDC or 24VAC for the camera.

When using a 12VDC adapter, connect the positive (+) pole to the '+' position and the negative (-) pole to the '-' position.

Use satisfy clause 2.5 of IEC60950-1/UL60950-1 or Certified/Listed Class 2 power source only.

- Be careful not to reverse the polarity when you connect the power cable.

- You can also use a router featuring PoE (Power over Ethernet) to supply power to the camera.

- 24VAC is recommended to use for the camera power for stable operation with heater kit. If using PoE, the heater will not operate at all.

2.4 Network Connection & IP assignment

The camera supports the operation through the network. When a camera is first connected to the network, it is necessary to allocate an IP address to the device with the SmartManager utility on the CD. (Default IP 192.168.0.129)

- 1) Connect the network camera/device to the network and power up.
- 2) Start SmartManager utility (Start > All programs > SmartManager > SmartManager). The main window will display, and after a short while any network devices connected to the network will be displayed in the list.

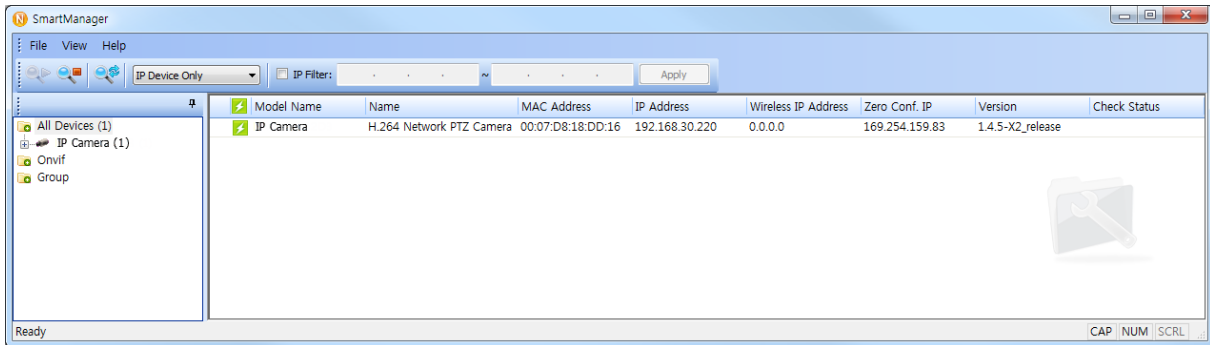

- 3) Select the camera on the list and click right button of the mouse. You can see the pop-up menu as below.

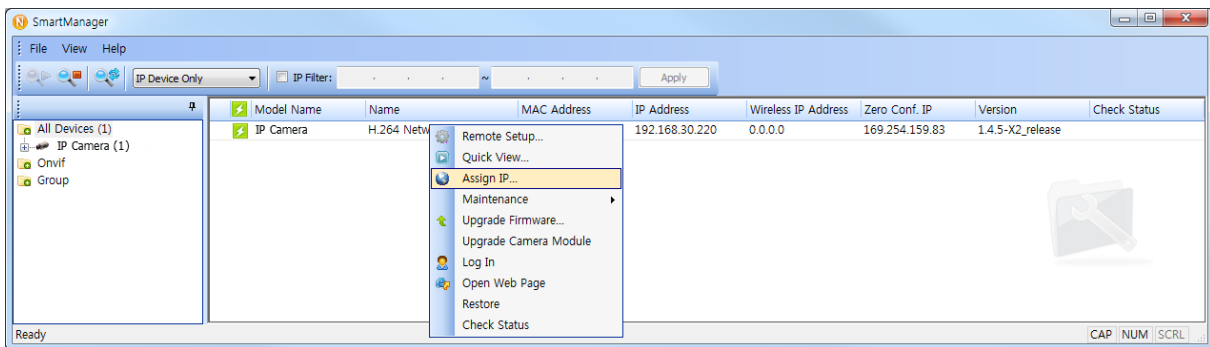

- 4) Select Assign IP Address. The Assign IP window will display. Enter the required IP address.

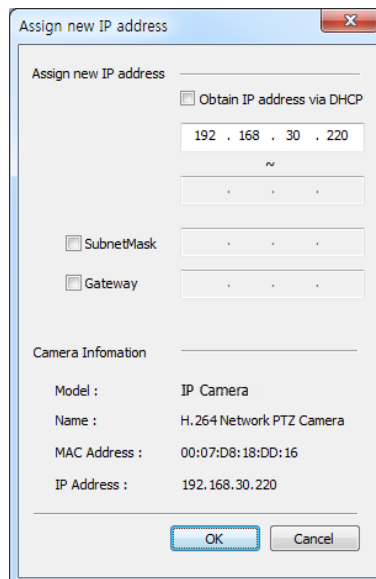

NOTE: For more information, refer to the SmartManager User's Manual.

3 Operation

The network camera can be used with Windows operating system and browsers. The recommended browsers are Internet Explorer, Safari, Firefox, Opera and Google Chrome with Windows.

NOTE: To view streaming video in Microsoft Internet Explorer, set your browser to allow ActiveX controls.

3.1 Access from a browser

1. Start a browser (Internet Explorer).
2. Enter the IP address or host name of the network camera in the Location/Address field of your browser.
3. You can see a starting page. Click **Live View**, **Playback**, or **Setup** to enter web page.



4. The network cameras Live View page appears in your browser.

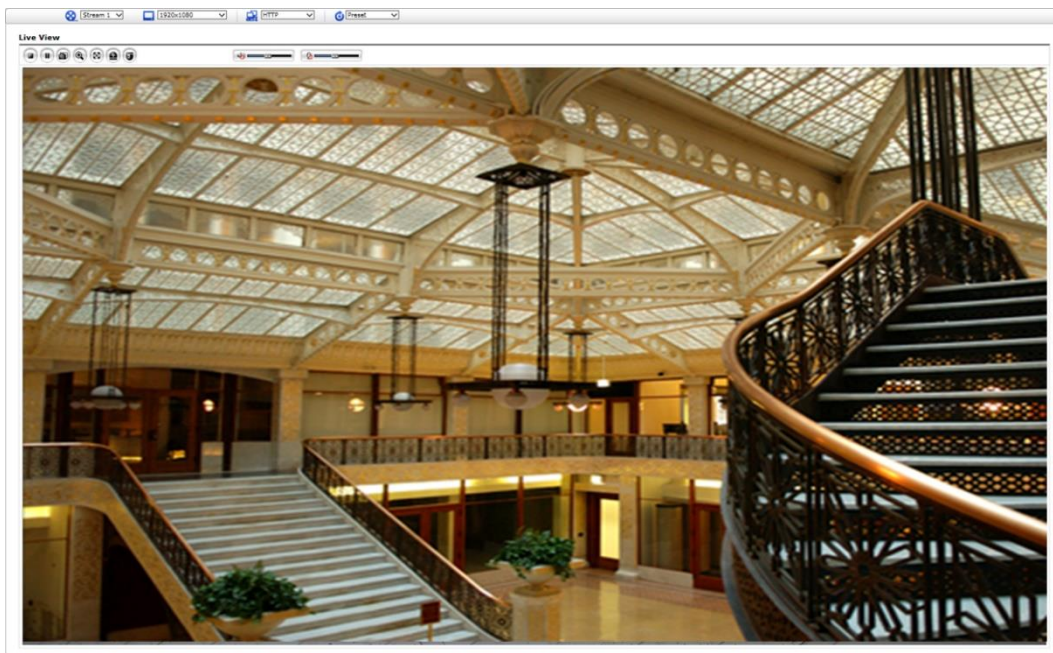

3.2 Access from the internet

Once connected, the network camera is accessible on your local network (LAN). To access the network camera from the Internet you must configure your broadband router to allow incoming data traffic to the network camera. To do this, enable the NAT traversal feature, which will attempt to automatically configure the router to allow access to the network camera. This is enabled from Setup > System > Network > NAT. For more information, please see "System > Network > NAT" of User's Manual.

3.3 Setting the admin password over a secure connection

To gain access to the product, the password for the default administrator user must be set. This is done in the Admin Password dialog, which is displayed when the network camera is accessed for the setup at the first time. Enter your admin name and password, set by the administrator.



NOTE: The default administrator user name and password is admin. If the password is lost, the network camera must be reset to the factory default settings. Please see Resetting to the factory default settings.

To prevent network eavesdropping when setting the admin password, this can be done via an encrypted HTTPS connection, which requires an HTTPS certificate (see NOTE below). To set the password via a standard HTTP connection, enter it directly in the first dialog shown below. To set the password via an encrypted HTTPS connection, please see "System > Security > HTTPS" of User's Manual.

NOTE: HTTPS (Hypertext Transfer Protocol over SSL) is a protocol used to encrypt the traffic between web browsers and servers. The HTTPS certificate controls the encrypted exchange of information.

3.4 Live View Page

The Live View page comes in several screen modes: 1920x1080, 1280x1024, 1280x720(960), 1024x768, 704x480(576), 640x480(360) and 320x240. Users are allowed to select the most suitable one out of those modes. Adjust the mode in accordance with your PC specifications and monitoring purposes.

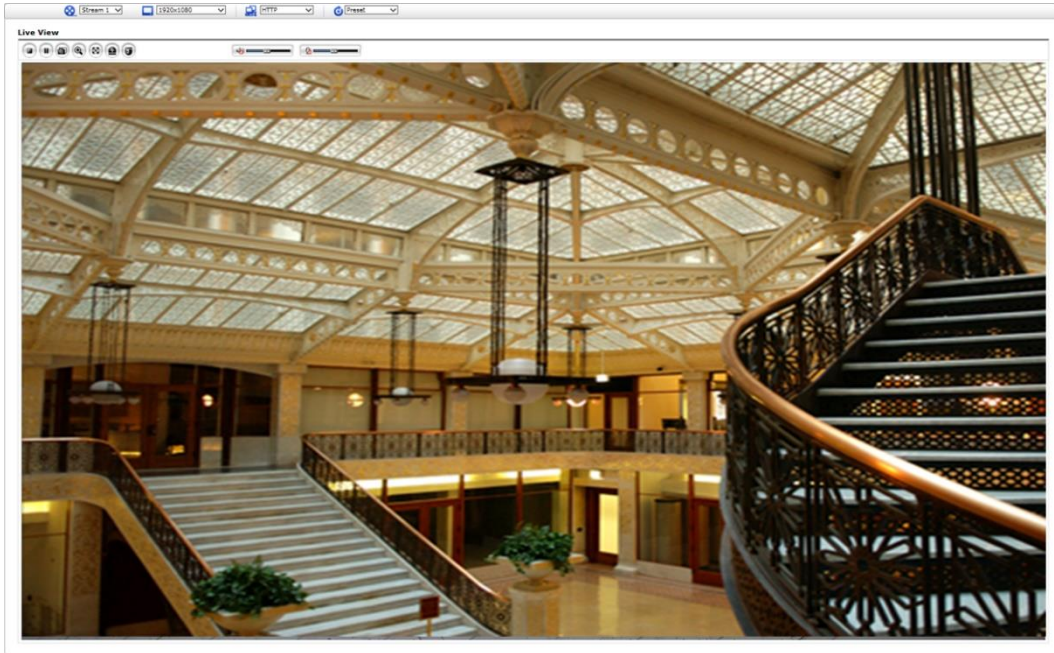

1) General controls



Live View Page



Playback Page



Setup Page



Help Page

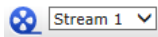

The video drop-down list allows you to select a customized or preprogrammed video stream on the Live View page. Stream profiles are configured under Setup > Basic Configuration > Video & Image. For more information, please see “Basic Configuration > Video & Image” of User’s Manual.

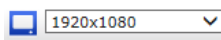

The resolution drop-down list allows you to select the most suitable one out of video resolutions to be displayed on Live View page.















The protocol drop-down list allows you to select which combination of protocols and methods to use depending on your viewing requirements, and on the properties of your network.



The preset drop-down list allows you to select the preset number for the PTZ camera being used. This icon is inactivated if the PTZ settings are not set.

2) Control toolbar

The live viewer toolbar is available in the web browser page only. It displays the following buttons:

-  The **Stop** button stops the video stream being played. Pressing the key again toggles the play and stop.
-  The **Play** button connects to the network camera or starts playing a video stream.
-  The **Pause** button pauses the video stream being played.
-  The **Snapshot** button takes a snapshot of the current image. The location where the image is saved can be specified.
-  The **Digital Zoom** button activates a zoom-in or zoom-out function for video image on the live screen.
-  The **Full Screen** button causes the video image to fill the entire screen area. No other windows will be visible. Press the 'Esc' button on the computer keyboard to cancel full screen view.
-  The **Manual Trigger** button activates a pop-up window to manually start or stop the event.
-  The **PTZ** button activates a pop-up window for Pan, Tilt and Zoom control.
-  The **VCA** button shows/hides VCA rule setting and detected objects.
-  The **Face Detector** button shows/hides detected faces.
-  The **Speaker** button activates/deactivates external speaker.
-  The **Mic** button activates/deactivates microphone input.
-  Use this scale to control the volume of the speakers and microphones.

NOTE1: VCA and Face Detector buttons appear only when each function is activated.

NOTE2: VCA and Face Detector works exclusively to each other.

3) Video Streams

The network camera provides several images and video stream formats. Your requirements and the properties of your network will determine the type you use.

The Live View page in the network camera provides access to H.264 and Motion JPEG video streams, and to the list of available video streams. Other applications and clients can also access these video streams/images directly, without going via the Live View page.

3.5 Playback

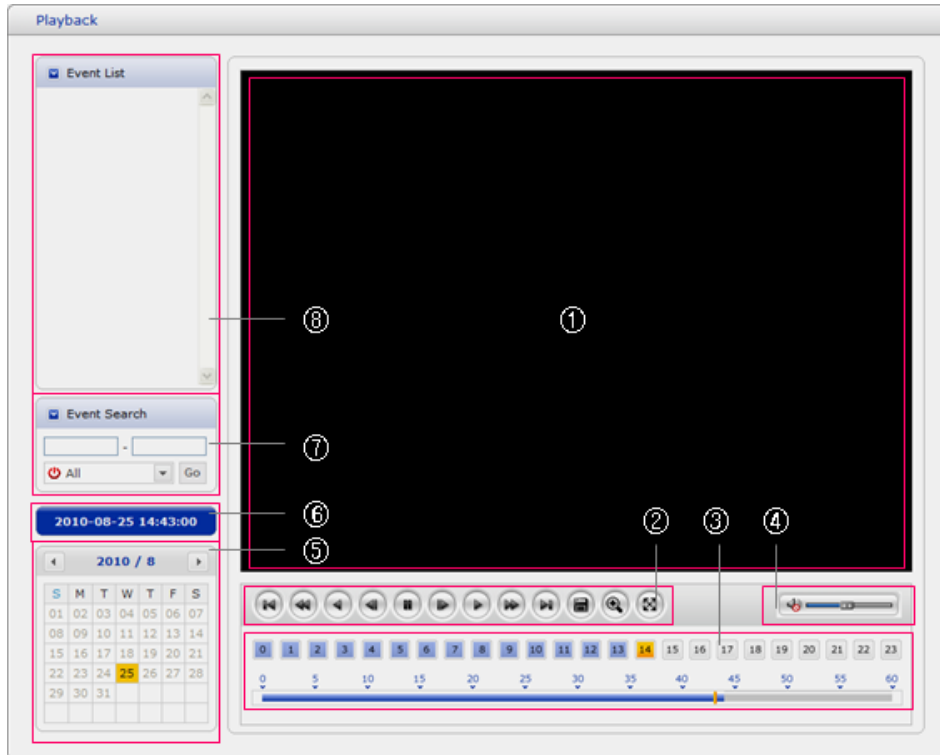

The Playback window contains a list of recordings made to the memory card. It shows each recording's start time, length, the event type used to start the recording, calendar and time slice bar indicates if the recording is existed or not.









The description of playback window follows.

1) Video Screen

You can see the video screen when playing the video clip in the Micro SD memory.

2) Playback Buttons

To view a recording data in the SD local storage, select it from the list and click the Playback buttons.

-  Go to the first: go to the beginning of the video clip.
-  Fast backward play: fast play backward of the video clip.
-  Backward play: play backward of the video clip.
-  Step backward play: go back one frame of the video clip.
-  Pause: pause playback of the video clip.
-  Step forward play: go forward one frame of the video clip.
-  Forward Play: play forward the video clip.
-  Fast forward play: play fast forward of the video clip.
-  Go to the last: go to the end of the video clip.
-  Clip copy: copy the video clip.
-  Zoom In: zoom in the video clip.
-  Full Screen: display full screen of the video.

3) Time Chart

Display an hour-based search screen for the chosen date. If there is recording data, a blue section will be displayed on a 24-hour basis. If you select a particular hour in the chart, a yellow square on the hour will be displayed.

4) Speaker Control Bar

Use this scale to control the volume of the speakers.

5) Search Calendar

Search results from the SD local storage in the network camera connected are displayed monthly. If there is a recorded data for a particular date, a blue square on the date will be displayed. If you select a particular date in the calendar, a yellow square on the date will be displayed.

6) Play Time

Displays time of the video playing.

7) Event Search Window

Select a search option in the drop-down list and click GO button. You can also enter the time period for searching. If you click Start Date or End Date zone, displays Search Calendar.

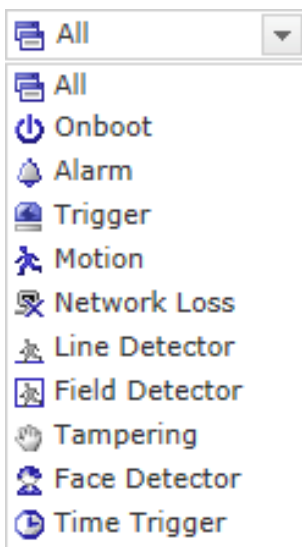

8) Event List Window

Event List displays the event(s) that were recorded in the SD local storage. Select a list and click the play button. The video clip will be played.

3.6 Network Camera Setup

This section describes how to configure the network camera.

Administrator has unrestricted access to all the Setup tools, whereas Operators have access to the settings of Basic Configuration, which are Live View, Video & Image, Audio, Event, Dome Configuration, and System.

You can configure the network camera by clicking Setup either in the first connection page or the top second-right button of the Live View page. Accessing the network camera from a computer for the first time opens the Admin Password dialog box. Enter your administrator or operator id and password to get into setup page.



NOTE: If the password is lost, the network camera must be reset to the factory default settings. Please see "Resetting to the Factory Default Setting".

3.6.1 Basic Configuration

You can see the device information in this information page.

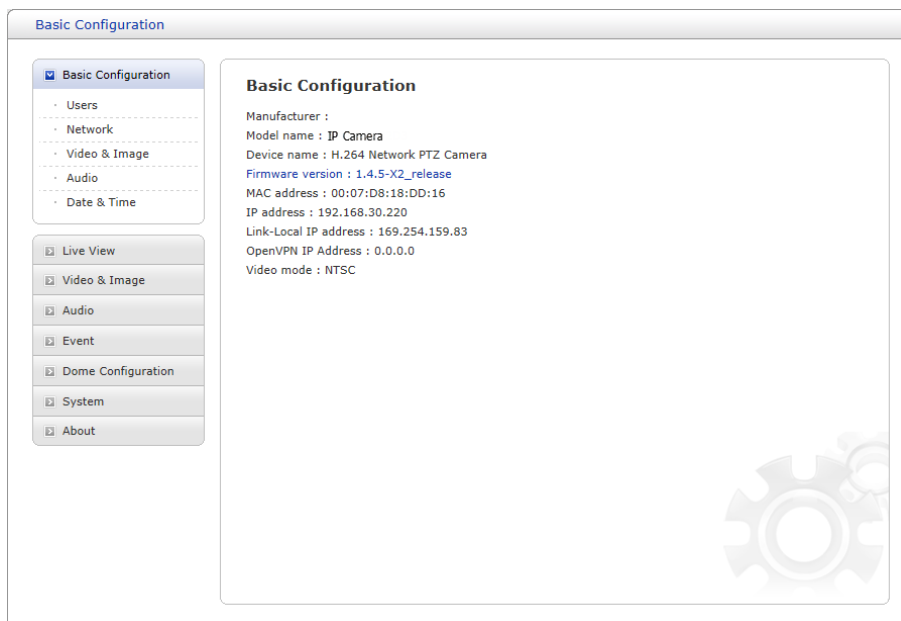

1) Users

User access control is enabled by default. The administrator can set up other users, by giving user names and passwords. It is also possible to allow anonymous viewer login, which means that anybody may access the Live View page, as described below:

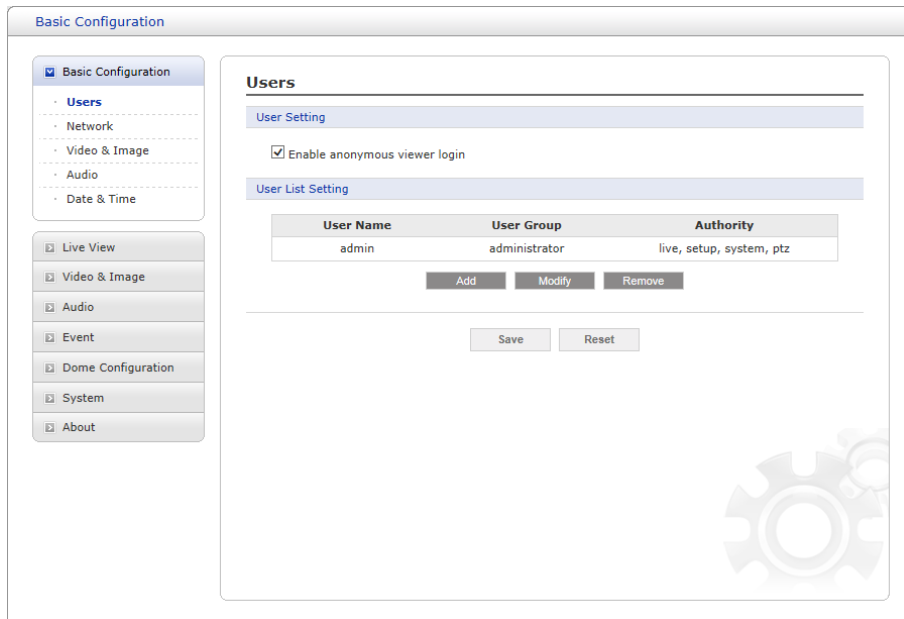

The **user list** displays the authorized users and user groups (levels):

User Group	Authority
Guest	Provides the lowest level of access, which only allows access to the Live View page.
Operator	An operator can view the Live View page, create and modify events, and adjust certain other settings. Operators have no access to System Options.
Administrator	An administrator has unrestricted access to the Setup tools and can determine the registration of all other users.

- **Enable anonymous viewer login:** Check the box to use the webcasting features. Refer to “Video & Image > Webcasting” for more details.

Please refer to “System > Security > Users” for more details about User setup.

2) Network

The network camera supports both IP version 4 and IP version 6. Both versions may be enabled simultaneously, and at least one version must always be enabled. When using IPv4, the IP address for the network camera can be set automatically via DHCP, or a static IP address can be set manually. If IPv6 is enabled, the network camera receives an IP address according to the configuration in the network router. There is also an option of using the Internet Dynamic DNS Service. For more information on setting the network, please see “System > Network > Basic”.

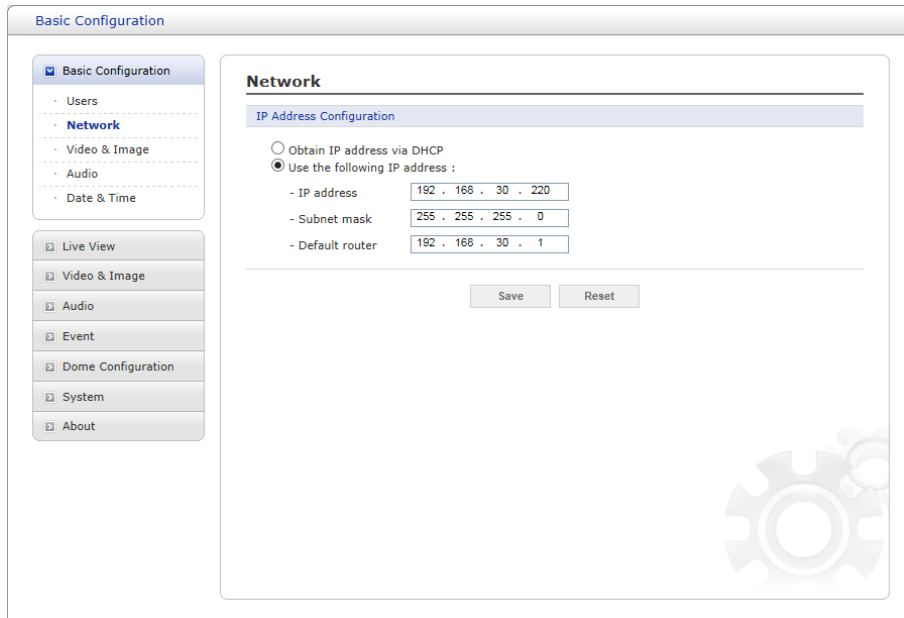

The screenshot shows the 'Basic Configuration' window with the 'Network' section selected. Under 'IP Address Configuration', the 'Use the following IP address' option is selected. The fields are filled with: IP address: 192.168.30.220, Subnet mask: 255.255.255.0, and Default router: 192.168.30.1. There are 'Save' and 'Reset' buttons at the bottom.

- **Obtain IP address via DHCP:** Dynamic Host Configuration Protocol (DHCP) is a protocol that lets network administrators centrally manage and automate the assignment of IP addresses on a network. DHCP is enabled by default. Although a DHCP server is mostly used to set an IP address dynamically, it is also possible to use it to set a static, known IP address for a particular MAC address.
- **Use the following IP address:** To use a static IP address for the network camera, check the radio button and then make the following settings:
 - **IP address:** Specify a unique IP address for your network camera.
 - **Subnet mask:** Specify the mask for the subnet the network camera is located on.
 - **Default router:** Specify the IP address of the default router (gateway) used for connecting devices attached to different networks and network segments.

NOTES:

1. DHCP should only be enabled if using dynamic IP address notification, or if your DHCP server can update a DNS server, which then allows you to access the network camera by name (host name). If DHCP is enabled and you cannot access the unit, you may have to reset it to the factory default settings and then perform the installation again.
2. The ARP/Ping service is automatically disabled two minutes after the unit is started, or as soon as an IP address is set.
3. Pinging the unit is still possible when this service is disabled.

Please refer to “System > Network > Basic” for more details about Network setup.

3) Video & Image

Basic Configuration

Video & Image

Sensor Setting

Capture mode: 1920x1080 Max. 30fps

Stream 1 Setting

Codec: H.264 Baseline Profile
Resolution: 1920x1080
Bitrate control: VBR CVBR
Bitrate: 4000 [Kbps]
Framerate: 30
GOP size: 30 [1 ...60]

Stream 2 Setting

Codec: MJPEG
Resolution: 640x480
Framerate: 30
Quality: 50 [1 ...100]

Stream 3 Setting

Codec: H.264 Baseline Profile
Resolution: 640x480
Bitrate control: VBR CVBR
Bitrate: 2000 [Kbps]
Framerate: 30
GOP size: 30 [1 ...60]

Save Reset

User can setup and change setting of individual video stream in this page.

Please refer to “Video & Image > Basic” for more details about Video & Image setup.

4) Audio

Basic Configuration

Audio

Audio Setting

Enable audio

- Compression type: G.711 u-law
- Sample rate: 8KHz
- Sound bitrate: 64kbps

Audio Input

Input: Internal Amp
Input volume: 0 [dB] Mute

Audio Output

Enable full duplex

- Output volume: 0 [dB] Mute

Save Reset

The network camera can transmit audio to other clients using an external microphone and can play audio received from other clients by attaching a speaker. User can setup and change setting of Audio in this page.

Please refer to “Audio” for more details about Audio setup.

5) Date & Time

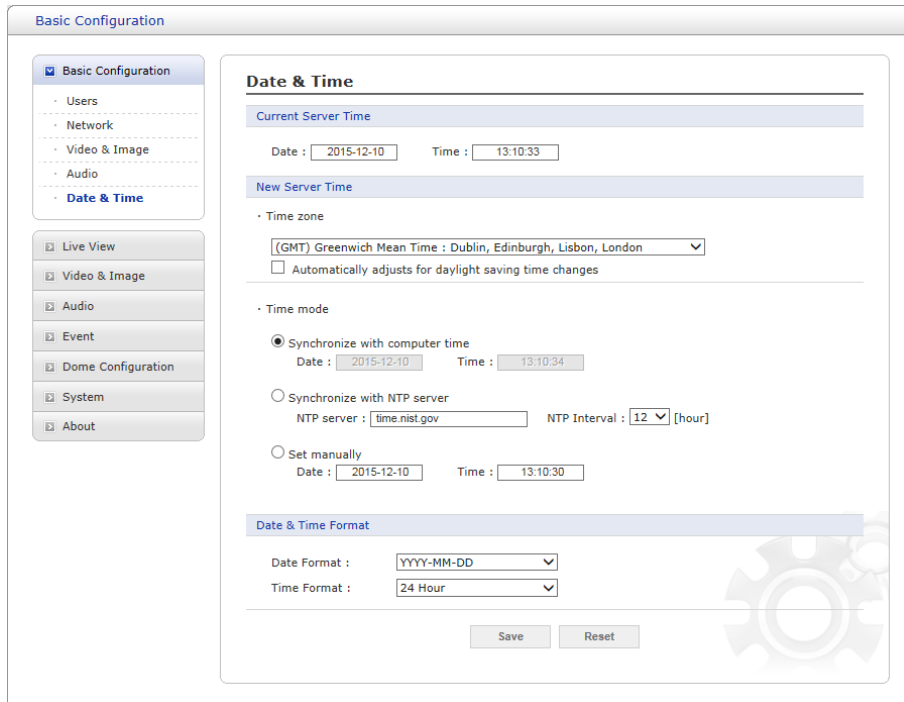

The screenshot shows the 'Basic Configuration' window with the 'Date & Time' section selected in the left sidebar. The main content area is titled 'Date & Time' and contains the following sections:

- Current Server Time:** Date: 2015-12-10, Time: 13:10:33
- New Server Time:**
 - Time zone: [(GMT) Greenwich Mean Time : Dublin, Edinburgh, Lisbon, London] (dropdown)
 - Automatically adjusts for daylight saving time changes
- Time mode:**
 - Synchronize with computer time
 - Date: 2015-12-10, Time: 13:10:34
 - Synchronize with NTP server
 - NTP server: time.nist.gov
 - NTP Interval: 12 [hour] (dropdown)
 - Set manually
 - Date: 2015-12-10, Time: 13:10:30
- Date & Time Format:**
 - Date Format: YYYY-MM-DD (dropdown)
 - Time Format: 24 Hour (dropdown)

At the bottom of the section are 'Save' and 'Reset' buttons.

User can set time directly or assign time server to get the current time, as well as determine Date & Time format in this page.

Please refer to “System > Date & Time” for more details about Date & Time setup.

3.6.2 Live View

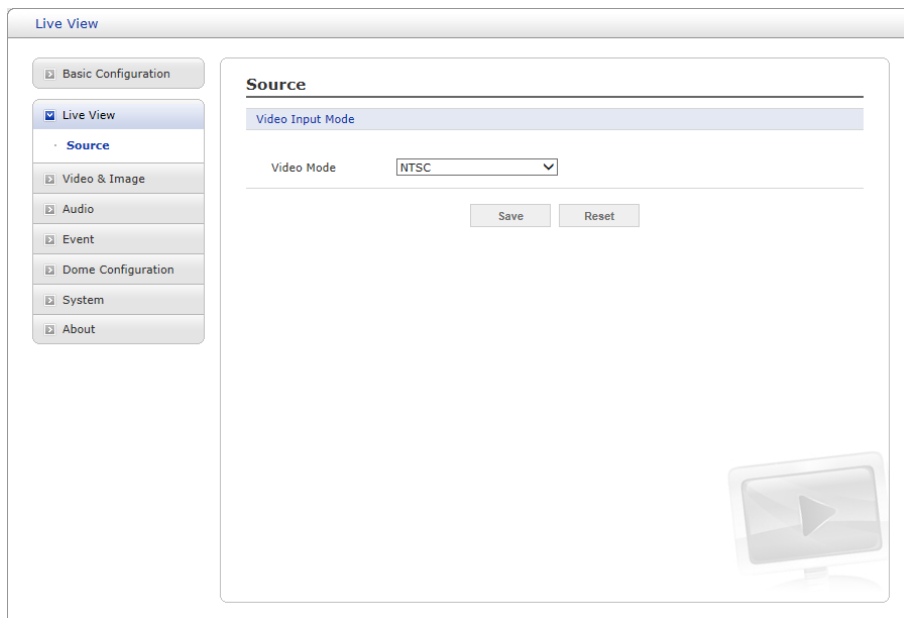

The screenshot shows the 'Live View' window with the 'Source' section selected in the left sidebar. The main content area is titled 'Source' and contains the following section:

- Video Input Mode:** Video Mode: NTSC (dropdown)

At the bottom of the section are 'Save' and 'Reset' buttons. A monitor icon with a play button is visible in the bottom right corner of the main content area.

- **Video Input Mode:**

- **Video Mode:** Choose Video Mode you wish to use from the drop-down list: NTSC or PAL

NOTE: This function may not be applicable, depending on the model.

3.6.3 Video & Image

1) Basic

The screenshot displays the 'Video & Image - Basic' configuration window. On the left is a navigation menu with options: Basic Configuration, Live View, Video & Image (selected), Audio, Event, Dome Configuration, System, and About. The 'Video & Image' section is expanded to show 'Basic' settings. The main area is divided into three sections: Sensor Setting, Stream 1 Setting, and Stream 2 Setting. Stream 3 Setting is also present but its details are partially obscured by a watermark of a film reel and clapperboard. The 'Sensor Setting' section includes a 'Capture mode' dropdown set to '1920x1080 Max. 30fps'. The 'Stream 1 Setting' section includes: Codec (H.264 Baseline Profile), Resolution (1920x1080), Bitrate control (radio buttons for VBR and CVBR, with CVBR selected), Bitrate (4000 [Kbps]), Framerate (30), and GOP size (30 [1 ...60]). The 'Stream 2 Setting' section includes: Codec (MJPEG), Resolution (640x480), Framerate (30), and a Quality slider set to 50 [1 ...100]. The 'Stream 3 Setting' section includes: Codec (H.264 Baseline Profile), Resolution (640x480), Bitrate control (radio buttons for VBR and CVBR, with CVBR selected), Bitrate (2000 [Kbps]), Framerate (30), and GOP size (30 [1 ...60]). At the bottom right, there are 'Save' and 'Reset' buttons.

- **Sensor Setting:**

- **Capture mode:** User can select sensor capture mode between 30 fps and 60 fps in full-HD resolution. If 60fps is selected, Stream 3 is disabled and hidden from the window. In other words, the camera provides triple stream at 30 fps and dual stream at 60 fps.

- **Stream 1 Setting:**

- **Codec:** The codec supported in Stream 1 is H.264. There are 3 pre-programmed stream profiles available for quick set-up. Choose the form of video encoding you wish to use from the drop-down list:
 - * **H.264 HP (High Profile):** Primary profile for broadcast and disc storage applications, particularly for high-definition television applications (for example, this is the profile adopted by the Blu-ray Disc storage format and the DVB HDTV broadcast service).
 - * **H.264 MP (Main Profile):** Primary profile for low-cost applications that require additional error robustness, this profile is used rarely in videoconferencing and mobile applications; it does add additional error resilience tools to the Constrained Baseline Profile. The importance of this profile is fading after the Constrained Baseline Profile has been defined.
 - * **H.264 BP (Baseline Profile):** Originally intended as the mainstream consumer profile for broadcast and storage applications, the importance of this profile faded when the High Profile was developed for those applications.
- **Resolution:** This enables users to determine a basic screen size when having an access through the Web Browser or PC program. The screen size control comes in seven modes like 1920x1080, 1280x1024, 1280x960, 1280x720, 1024x768, 704x576, 704x480, 640x480, 640x360 and 320x240. Users can change the selected screen size anytime while monitoring the screen on a real-time basis.

– **Bitrate control:** The bit rate can be set as Variable Bit Rate (VBR) or Constrained Variable Bit Rate (CVBR). VBR adjusts the bit rate according to the image complexity, using up bandwidth for increased activity in the image, and less for lower activity in the monitored area. Limiting the maximum bit rate helps control the bandwidth used by the H.264 video stream. Leaving the Maximum bit rate as unlimited maintains consistently good image quality but increases bandwidth usage when there is more activity in the image. Limiting the bit rate to a defined value prevents excessive bandwidth usage, but images are degraded when the limit is exceeded.

* **VBR:** unlimited maximum bitrate.

* **CVBR:** VBR with maximum bitrate which is set in **Bitrate**.

– **Bitrate:** Maximum bitrate for CVBR in the range of 100kbps ~ 8Mbps. This is disabled if Bitrate control is set to VBR.

– **Frame rate:** Upon the real-time play, users should select a frame refresh rate per second. If the rate is high, the image will become smooth. On the other hand, if the rate is low, the image will not be natural but it can reduce a network load.

– **GOP size:** Select the GOP (Group of Picture) size. If users want to have a high quality of fast image one by one, please decrease the value. For the purpose of general monitoring, please do not change a basic value. Such act may cause a problem to the system performance. For the details of GOP setting, please contact the service center.

• **Stream 2 Setting:**

Sometimes the image size is large due to low light or complex scenery. Adjusting the frame rate and quality helps to control the bandwidth and storage used by the Motion JPEG video stream in these situations. Limiting the frame rate and quality optimizes bandwidth and storage usage, but may give poor image quality. To prevent increased bandwidth and storage usage, the Resolution, Frame rate, and Frame Quality should be set to an optimal value.

– **MJPEG Resolution:** Same as the stream 1 settings.

– **MJPEG Frame rate:** Same as the stream 1 settings.

– **MJPEG Quality:** Select the picture quality. If users want to have a high quality of fast image one by one, please decrease the value. For the purpose of general monitoring, please do not change a basic value. Such act may cause a problem to the system performance.

• **Stream 3 Setting:** Same as the Stream 1 Setting.

When the settings are complete, click **Save** button to save the settings, or click **Reset** button to clear all of the information you entered without saving it.

2) Auto Focus

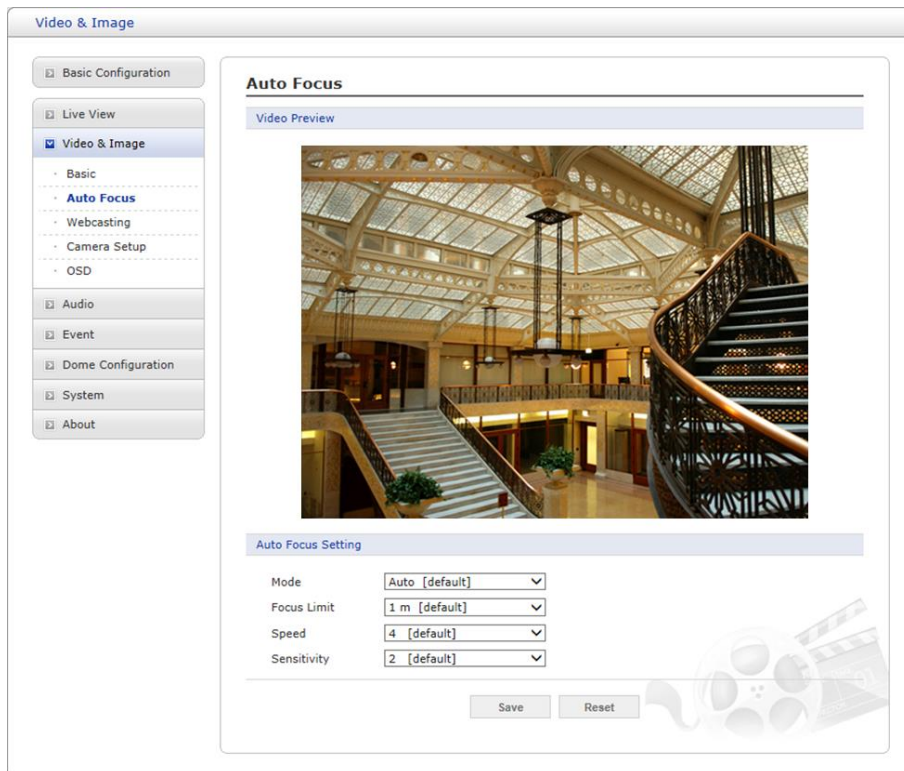

- **Mode:** Determines focus operation method.
 - **Auto:** Auto Focus is always active.
 - **Manual:** User can manually focus the camera when camera is not moving. Auto Focus becomes active when camera moves and about 5 seconds after movement stops.
 - **One Push:** Basically the same as **Manual** mode except that Auto Focus is activated only after the camera movement stops and lasts for about 5 seconds.
- **Focus Limit:** Minimum distance for Auto Focus operation. Object nearer than this limit may not be clearly focused.
- **Speed:** Focus speed can be adjusted in the range of 1 - 8.
- **Sensitivity:** Focus sensitivity can be adjusted in the range of 1 - 3.

NOTE: Avoid continuous, 24-hour use of the auto focus. This will shorten the lifespan of the lens.

When the settings are complete, click **Save** button to save the settings, or click **Reset** button to clear all of the information you entered without saving it.

3) Webcasting

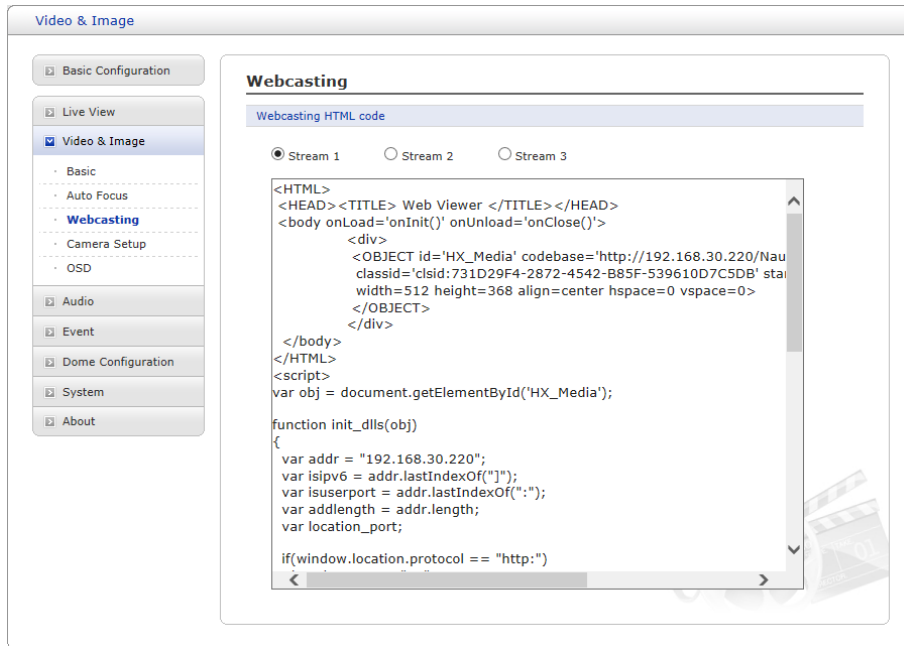

The live video of the camera can be streamed to a website. User can copy and paste the HTML code generated on the screen to the website page code, where user wants to display live video.

NOTE: To use webcasting service, the Enable Anonymous viewer login option must be checked.

4) Camera Setup

Video & Image

Basic Configuration

Live View

Video & Image

- Basic
- Auto Focus
- Webcasting
- Camera Setup**
- OSD

Audio

Event

Dome Configuration

System

About

Camera Setup

Video Preview

Video Preview

Exposure Control

Mode Automatic Manual

Max. gain Low Middle High

Shutter Automatic Fixed

Iris Automatic Fixed

Enable high light compensation

Enable backlight compensation

Enable wide dynamic range

White Balance Control

Mode Automatic Fixed incandescent

Fixed fluorescent Fixed outdoor

Manual

R Gain [1 ... 255] [default] : 100

B Gain [1 ... 255] [default] : 80

Image Appearance

Brightness [1 ... 10] [default] : 4

Saturation [1 ... 10] [default] : 5

Sharpness [1 ... 10] [default] : 3

Enable flip horizontally

Enable noise reduction

Level Low Middle High

Enable defog

Enable digital image stabilization

Enable digital zoom

Day & Night Control

Mode Automatic Day Night

Threshold Low Middle High

Save Reset

In this page, user can setup Exposure Control, White Balance Control, Image Appearance, and Day & Night control.

- **Video Preview:** User can check the setting via video preview pop-up window

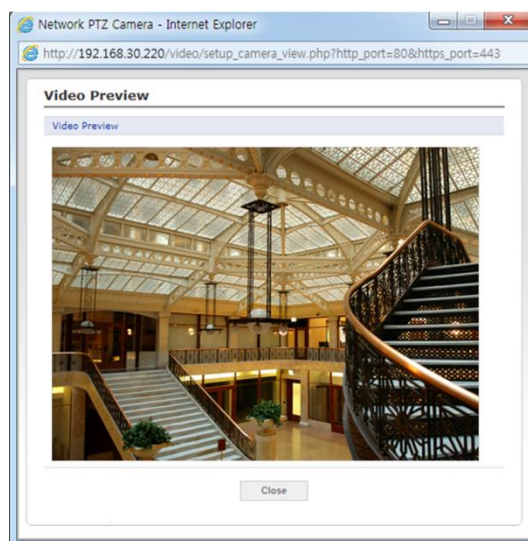

• Exposure Control

The screenshot shows the 'Exposure Control' panel with the following settings:

- 1 Mode:** Automatic, Manual
- 2 Max. gain:** Low, Middle, High
- 3 Shutter:** Automatic, Fixed
- 4 Shutter speed:** 1/30
- 5 Iris:** Automatic, Fixed
- 6 Iris F number:** F3.9
- 7 Enable high light compensation:**
- 8 Level:** Slider set to 5, range [1 ... 9], [default] : 5
- 9 Enable backlight compensation:**
- 10 Enable wide dynamic range:**
- 11 Strength:** Low, Middle, High

- 1. Mode:** Determines exposure mode between automatic and manual. For automatic mode, at least one of Shutter and Iris should be set to automatic. For manual mode, both Shutter and Iris become fixed.
- 2. Max. gain:** Sets maximum gain if Mode is automatic.
- 3. Shutter:** Determines shutter mode between automatic and fixed.
- 4. Shutter speed:** Select shutter speed if Shutter is in fixed mode.
- 5. Iris:** Determines Iris mode between automatic and fixed.
- 6. Iris F number:** Select Iris F number if Iris is in fixed mode.
- 7. Enable high light compensation:** Activates HLC function.
- 8. Level:** Determines HLC level.
- 9. Enable backlight compensation:** Activates BLC function which cannot be used with WDR.
- 10. Enable wide dynamic range:** Activates WDR which cannot be used with BLC or Defog function.
- 11. Strength:** Determines WDR strength.

• White Balance Control

The screenshot shows the 'White Balance Control' panel with the following settings:

- 1 Mode:** Automatic, Fixed incandescent, Fixed fluorescent, Fixed outdoor, Manual
- 2 R Gain:** Slider set to 100, range [1 ... 255], [default] : 100
- B Gain:** Slider set to 80, range [1 ... 255], [default] : 80

- 1. Mode:** Select one of five white balance mode which fits camera installation location environment.
- User can separately set R Gain and B Gain in manual mode.
 - **R Gain:** red color gain in the range of 1 - 255 with default value 100.
 - **B Gain:** blue color gain in the range of 1 - 255 with default value 80.

• Image Appearance

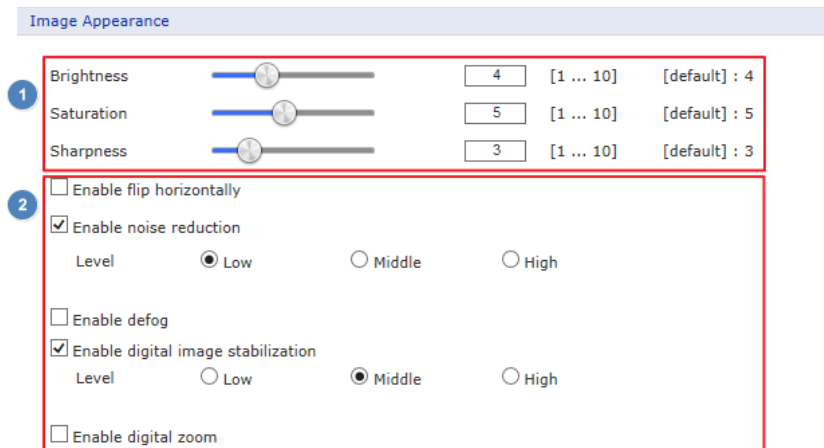

Image Appearance

1 Brightness [1 ... 10] [default] : 4

2 Saturation [1 ... 10] [default] : 5

Sharpness [1 ... 10] [default] : 3

Enable flip horizontally

Enable noise reduction

Level Low Middle High

Enable defog

Enable digital image stabilization

Level Low Middle High

Enable digital zoom

User can setup image related controls.

1. User can either use slide bar or type in number for items in 1.
2. User can select individual function and level.

NOTE: Defog function cannot be used in conjunction with WDR.

• Day & Night Control

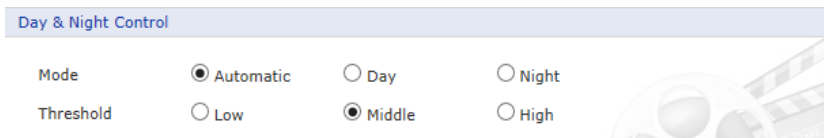

Day & Night Control

Mode Automatic Day Night

Threshold Low Middle High

User can setup Day & Night operation mode among Automatic, Day, and Night.

– Mode:

- * **Automatic:** Normally displays color image, and switches automatically to black & white image after the ambient light level reaches a pre-defined threshold.
- * **Day:** Always displays color image.
- * **Night:** Always displays black & white image.

- **DN Threshold:** Adjusts the level of light which the camera automatically switches between color and black & white image.

When the settings are complete, click **Save** button to save the settings, or click **Reset** button to clear all of the information you entered without saving it.

5) OSD

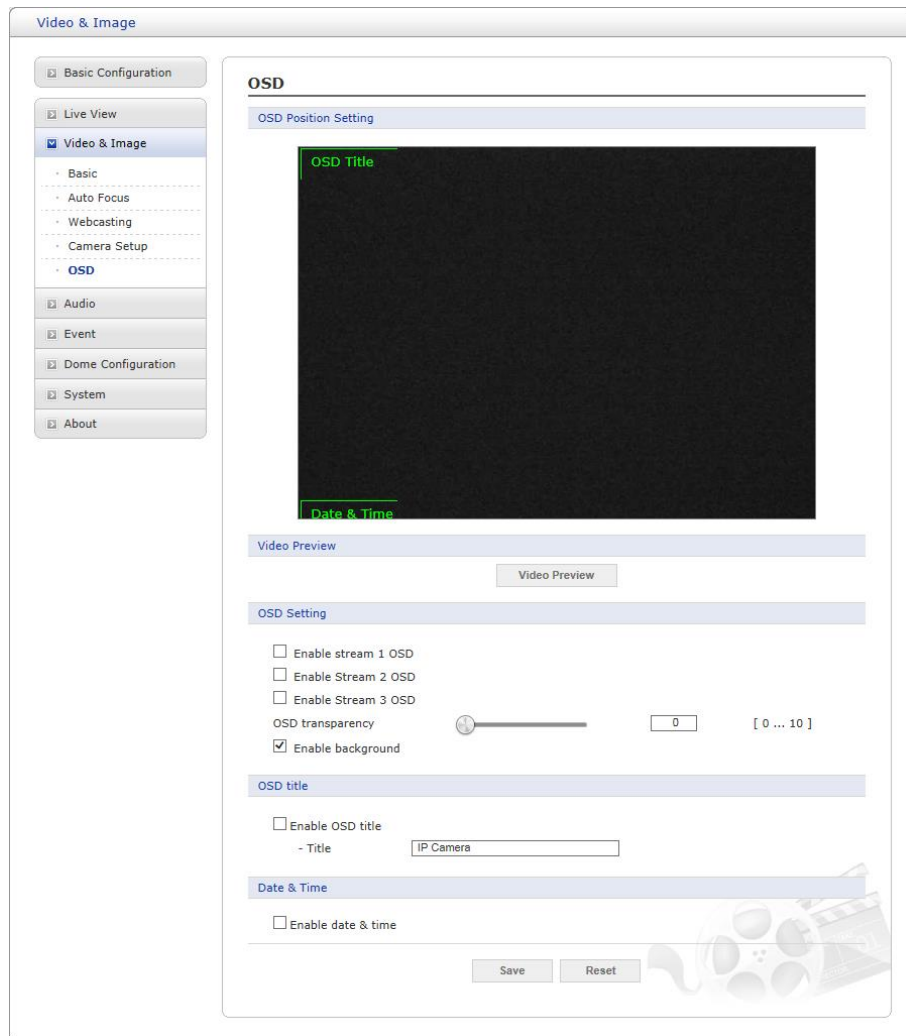

This camera provides two OSD's (on screen display) on each stream, title and date & time. User can drag green "OSD Title" and "Date & Time" to the desired position and check at preview window.

- **Video Preview:** User can check the position of OSD on actual video via preview popup window.
- **OSD Setting:** User can determine show or hide OSD for each stream. Also user can set the transparency level of OSD by slide bar or type in number.
- **OSD title:** User can show or hide OSD title, and can change OSD title by type in. The default is the model name of the camera.
- **Date & Time:** User can show or hide date & time on OSD.

NOTE: The change in this page immediately affects video stream.

3.6.4 Audio

The network camera can transmit audio to other clients using an external microphone and can play audio received from other clients by attaching a speaker. The Setup page has an additional menu item called Audio, which allows different audio configurations, such as full duplex and simplex.

- **Audio Setting:**

- **Enable audio:** Check the box to enable audio in the video stream.
- **Compression type:** Select the desired audio Compression format between G.711 μ -law or G.711 a-law.
- **Sample rate:** Select the required Sample rate (number of times per second the sound is sampled). The higher the sample rate, the better the audio quality and the greater the bandwidth required.
- **Sound bit rate:** Depending on the selected encoding, set the desired audio quality (bit rate). The settings affect the available bandwidth and the required audio quality.

- **Audio Input:** Audio from an external line source can be connected to the STEREO Jack I/O of the network camera.

- **Input:** User can select amplifier between Internal Amp or External Amp.
- **Input volume:** If there are problems with the sound input being too low or high, it is possible to adjust the input gain for the microphone attached to the network camera.

- **Audio Output:**

- **Enable full duplex:** Check the box to enable Full Duplex mode. This means that you can transmit and receive audio (talk and listen) at the same time, without having to use any of the controls. This is just like having a telephone conversation. This mode requires that the client PC has a sound card with support for full-duplex audio.

Uncheck the box enable Simplex mode. The simplex mode only transmits audio from the network camera to any web client. It does not receive audio from other web clients.

- **Output volume:** If the sound from the speaker is too low or high it is possible to adjust the output gain for the active speaker attached to the network camera.

When the settings are complete, click **Save** button to save the settings, or click **Reset** button to clear all of the information you entered without saving it.

3.6.5 Event

1) Event In

▽ On Boot

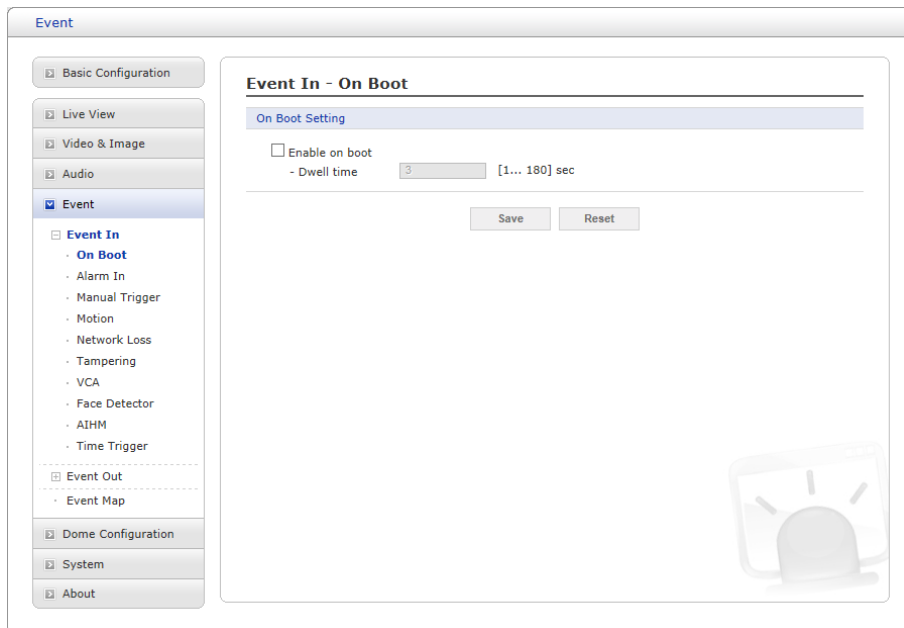

The screenshot shows a web interface for configuring an event. On the left is a sidebar menu with the following items: Basic Configuration, Live View, Video & Image, Audio, Event (selected), Event In (expanded), Event Out, Dome Configuration, System, and About. Under 'Event In', the following options are listed: On Boot (selected), Alarm In, Manual Trigger, Motion, Network Loss, Tampering, VCA, Face Detector, AIHM, and Time Trigger. The main content area is titled 'Event In - On Boot' and contains an 'On Boot Setting' section. It features a checkbox for 'Enable on boot' which is currently unchecked. Below it is a 'Dwell time' field with a value of '3' and a range of '[1... 180] sec'. At the bottom of the settings area are 'Save' and 'Reset' buttons. A small icon of a camera is visible in the bottom right corner of the main content area.

This is used to trigger an event every time the network camera is started. Select “Enable on boot” to activate the On Boot event.

Enter the Dwell time the event lasts from the point of detection, 1-180 seconds.

When the settings are complete, click **Save** button to save the settings, or click **Reset** button to clear all of the information you entered without saving it.

▽ Alarm In 1

The screenshot displays the 'Event In - Alarm In' configuration page. The left sidebar lists various system settings, with 'Event In' selected. The main content area is divided into four sections, one for each alarm port. Each section includes an 'Enable alarm in port #' checkbox, a 'Type' dropdown menu (currently set to 'NO'), and a 'Dwell time' input field (set to '3') with a range of '[1... 180] sec'. At the bottom right, there are 'Save' and 'Reset' buttons, along with a small icon of a camera with a bell.

This camera provides 4 Alarm In ports and user can set each port individually. Each Port can be given as Normally Open or Normally Close state, and their Normal state can be configured. In order to use an alarm port, check the desired "Enable alarm port #" first.

- **Type:** Choose the type of alarm to use from the drop-down list, NO (Normally Open) or NC (Normally Closed).
- **Dwell Time:** Set the dwell time an event lasts from the point of detection of an alarm input.

When the settings are complete, click **Save** button to save the settings, or click **Reset** button to clear all of the information you entered without saving it.

▽ Manual Trigger

Event

- Basic Configuration
- Live View
- Video & Image
- Audio
- Event
 - Event In
 - On Boot
 - Alarm In
 - Manual Trigger**
 - Motion
 - Network Loss
 - Tampering
 - VCA
 - Face Detector
 - AIHM
 - Time Trigger
 - Event Out
 - Event Map
- Dome Configuration
- System
- About

Event In - Manual Trigger

Manual Trigger 1 Setting

Enable manual trigger 1
- Dwell time [1... 180] sec

Manual Trigger 2 Setting

Enable manual trigger 2
- Dwell time [1... 180] sec

Manual Trigger 3 Setting

Enable manual trigger 3
- Dwell time [1... 180] sec

Manual Trigger 4 Setting

Enable manual trigger 4
- Dwell time [1... 180] sec

This option makes use of the manual trigger button provided on the Live View page, which is used to start or stop the event type manually. Alternatively, the event can be triggered via the product's API (Application Programming Interface).

Select "Enable manual trigger" to activate the manual trigger (for up to 4 manual triggers).

Set the dwell time the trigger lasts.

When the settings are complete, click **Save** button to save the settings, or click **Reset** button to clear all of the information you entered without saving it.

▽ Motion

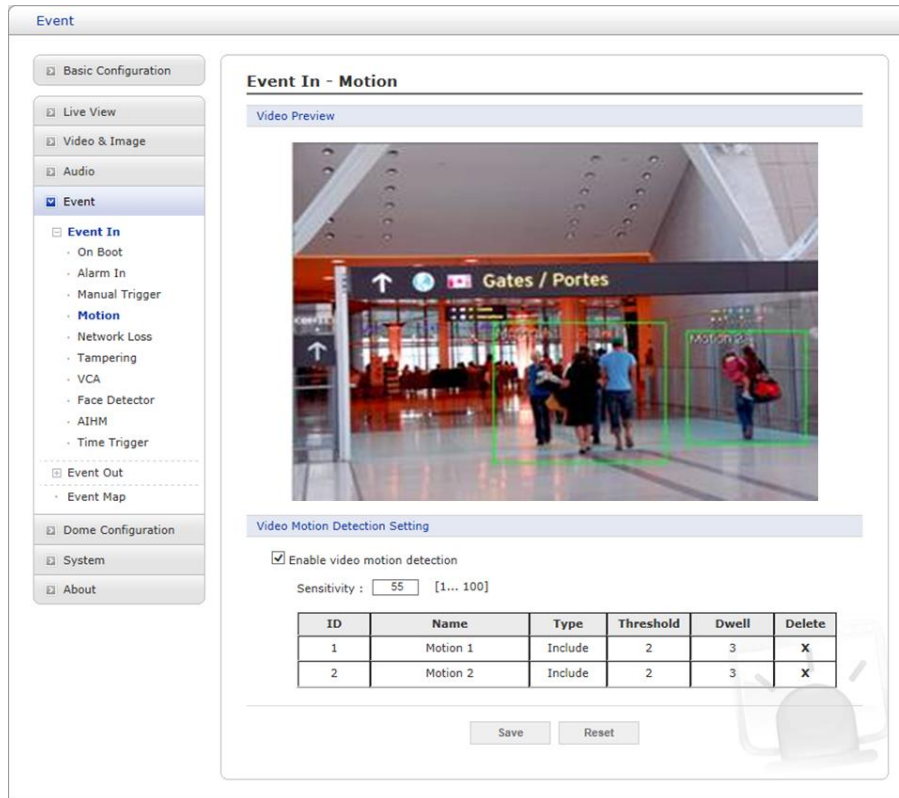

This option makes use of the motion detection function with 16 programmable areas, 8 **Include** and **Exclude** zones each.

Click right mouse button on the preview window shows selection pop-up of **New Motion, New Mask, Select, Delete, and Freeze**.

Select **New Motion** and click & drag generates an **Include** box of green color.

Select **New Mask** and click & drag generates an **Exclude** box of orange color.

Drag corner or line resizes and drag inside moves the box.

Select "Enable video motion detection" to activate motion detection.

- **Sensitivity:** User can change sensitivity of this function, where large value sets more sensitive detection.
- **Zone List**
 - **ID:** Order of generation, **Include** 1~8, **Exclude** 9~16.
 - **Name:** User definable zone name.
 - **Type:** shows zone type and cannot be changed.
 - **Threshold:** Determines how large the motion in the zone can trigger event in percentage.
 - **Dwell time:** Determines how long the triggered event holds from the last triggering.

User can select any box by clicking name on the preview window or click on the list. User can delete selected zone via right mouse click selection for a selected box, or click any one of **X** button in the zone list.

When the settings are complete, click **Save** button to save the settings, or click **Reset** button to clear all of the information you entered without saving it.

▽ Network Loss

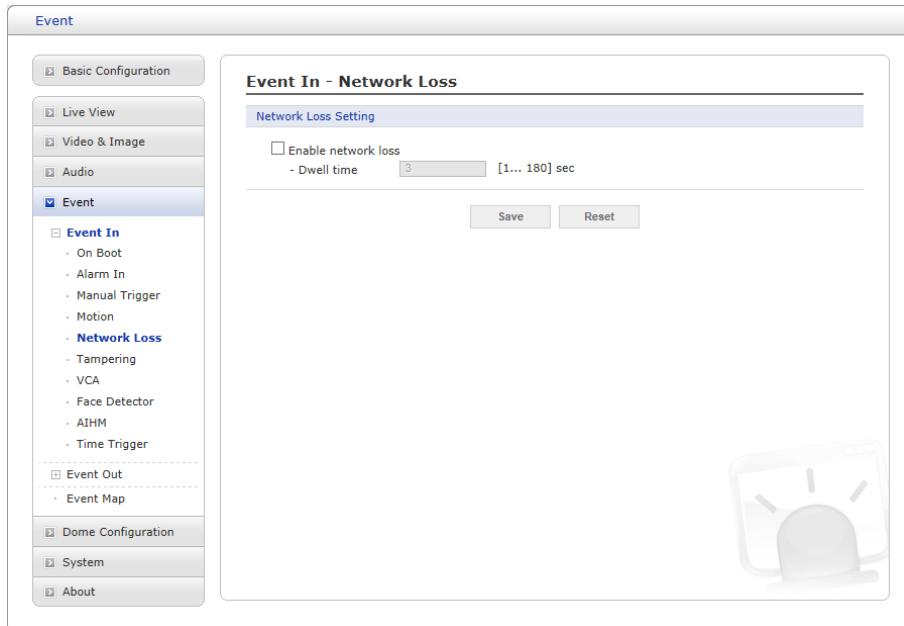

The screenshot displays a web interface for configuring an event. On the left is a sidebar with a tree view containing the following items: Basic Configuration, Live View, Video & Image, Audio, Event (selected), Event In (expanded), On Boot, Alarm In, Manual Trigger, Motion, Network Loss (highlighted), Tampering, VCA, Face Detector, AIHM, Time Trigger, Event Out, Event Map, Dome Configuration, System, and About. The main content area is titled 'Event In - Network Loss' and features a 'Network Loss Setting' section. This section includes a checkbox for 'Enable network loss' which is currently unchecked. Below it is a 'Dwell time' field with a numeric input set to '3' and a range indicator '[1... 180] sec'. At the bottom of the settings area are 'Save' and 'Reset' buttons. A faint icon of a dome camera is visible in the bottom right corner of the main content area.

This is used to trigger an event every time the network connection is failed. Select “Enable network loss” to activate the Network Loss event. Select a dwell time for how long the event will last from the point of detection.

When the settings are complete, click **Save** button to save the settings, or click **Reset** button to clear all of the information you entered without saving it.

▽ Tampering

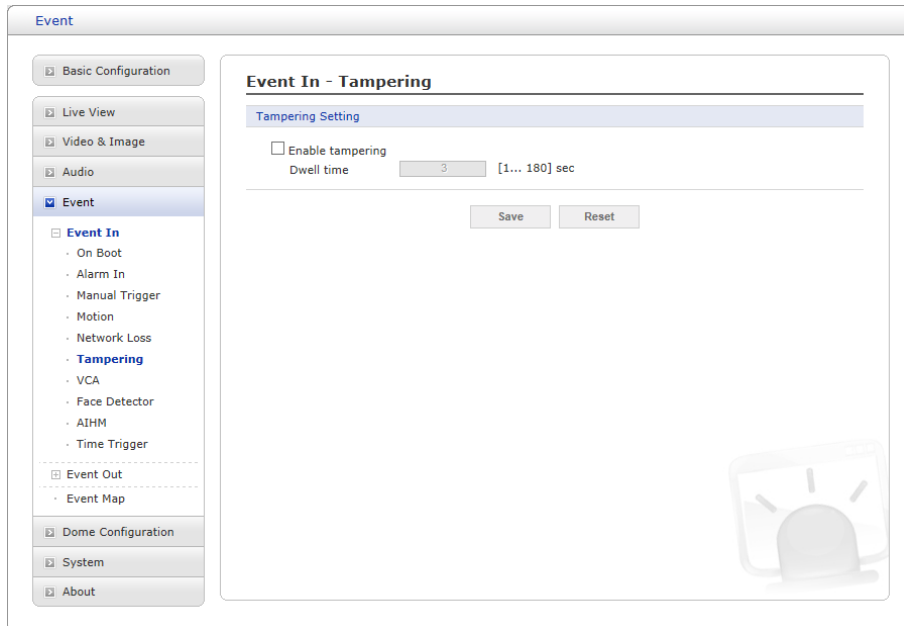

This is used to trigger an event when camera tampering occurs, for example, obstruct the camera with foreign material or move camera direction using external force. Select “Enable tampering” to activate the Tampering event.

- **Dwell time:** Determine how long the event will last from the point of detection.

When the settings are complete, click **Save** button to save the settings, or click **Reset** button to clear all of the information you entered without saving it.

▽ VCA

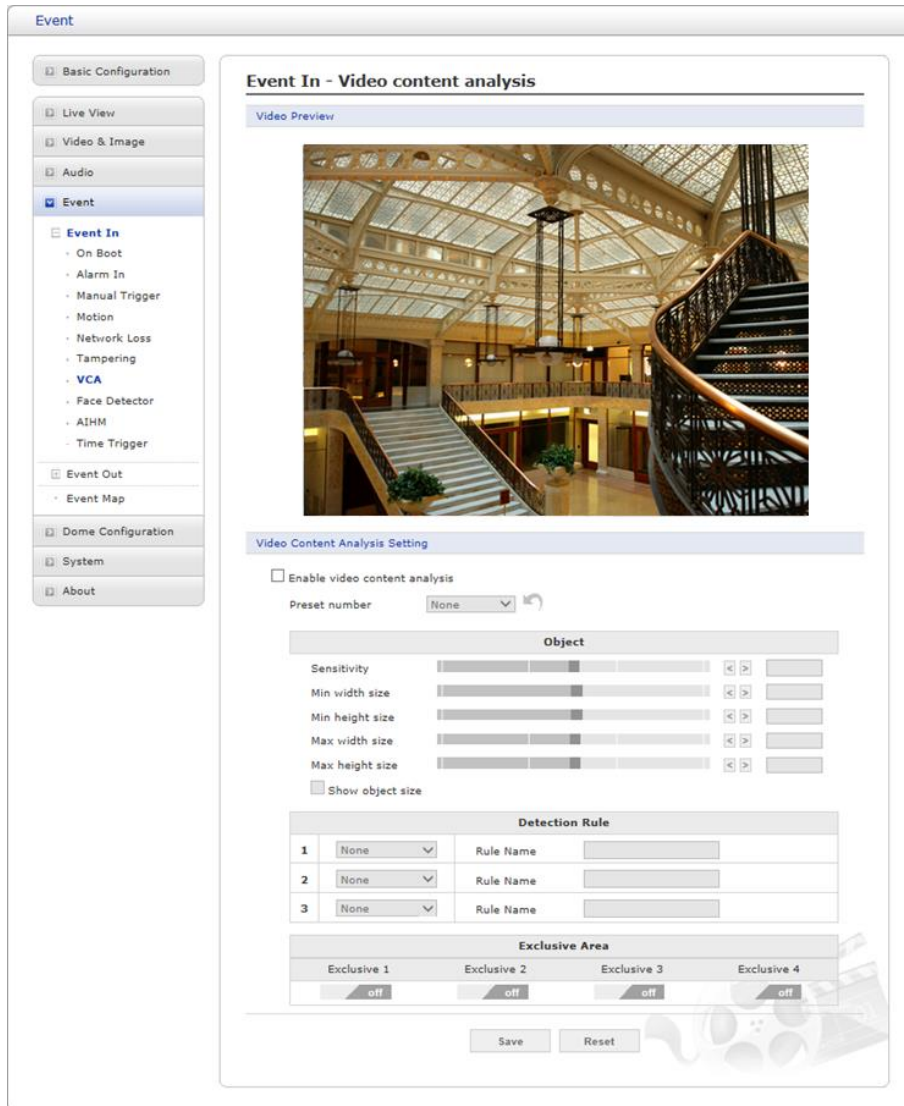

The network cameras provide VCA (Video Content Analysis) functions of “Line Detector” and “Field Detector”.

- **Video Content Analysis Setting:** Check **Enable video content analysis** box to use a VCA function. In order to setup VCA function, at least one preset position must exist, and otherwise **Enable video content analysis** may not be activated.
 - **Preset number:** User can assign different rules for each preset position. Select the preset position to set the VCA rules.
 - **Object:** Determines detection sensitivity.
 - * **Sensitivity:** As the value becomes bigger, the detection sensitivity increases.
 - * **Min width size:** Minimum horizontal pixel size for detections in a 1920x1080 format.
 - * **Min height size:** Minimum vertical pixel size for detections in a 1920x1080 format.
 - * **Max width size:** Maximum horizontal pixel size for detections in a 1920x1080 format.
 - * **Max height size:** Maximum vertical pixel size for detections in a 1920x1080 format.
 - **Detection Rule:** User can assign up to 3 different rules for each preset position.
 - * **Line Detector:** Once selected, a **red** line appears on the video preview window. Drag and drop the line at the desired position. User can change the length and the slope by dragging each end of the line.

- . **Rule Name:** User can type in the rule name.
- . **Direction:** This detector can detect line crossing events and also count up number of the event; the direction of the event appears as a solid triangle shape at the center of the line.
- . **Base:** The reference point of the object detection.
- . **Counter:** User can choose between Counter and Detector.
- * **Field Detector:** Once selected, a **blue** line appears on the video preview window. Drag and drop the box at the desired position. User can change the shape of the box by dragging each corner to any shape of a quadrilateral.
 - . **Rule Name:** User can type in the rule name.
 - . **Base:** The reference point of the object detection.
 - . **Mode:** Currently Enter rule only.
- **Exclusive Area:** The area where the rules are not applied. Once selected, a **purple** line appears on the video preview window. Drag and drop the box at the desired position.
User can change the shape of the box by dragging each corner to any form of a quadrilateral.

NOTE: Video Content Analysis function cannot be used in conjunction with Motion Detection function. If you choose **Enable video content analysis**, motion detection function is automatically turned off.

When the settings are complete, click **Save** button to save the settings, or click **Reset** button to clear all of the information you entered without saving it.

▽ Face Detector

The screenshot shows a web-based configuration interface for a security system. On the left is a sidebar menu with the following items: Basic Configuration, Live View, Video & Image, Audio, Event (selected), Event Out, Dome Configuration, System, and About. Under the 'Event' menu, the 'Event In' section is expanded, listing: On Boot, Alarm In, Manual Trigger, Motion, Network Loss, Tampering, VCA, Face Detector (highlighted), AIHM, and Time Trigger. The main content area is titled 'Event In - Face Detector' and contains a 'Video Preview' showing a live feed of a large, ornate staircase. Below the video is the 'Face Detector Setting' section, which includes an unchecked checkbox for 'Enable face detector' and a 'Threshold' input field with the value '32' and a range indicator '[1... 64]'. At the bottom of the settings are 'Save' and 'Reset' buttons. A faint watermark of a dome-shaped camera is visible in the bottom right corner of the interface.

This is used to detect a human face in the scene to trigger event with a bounding box for the detected face. Select “Enable face detector” to activate the Face Detector. Set threshold for detection sensitivity.

When the settings are complete, click **Save** button to save the settings, or click **Reset** button to clear all of the information you entered without saving it.

▽ AHIM

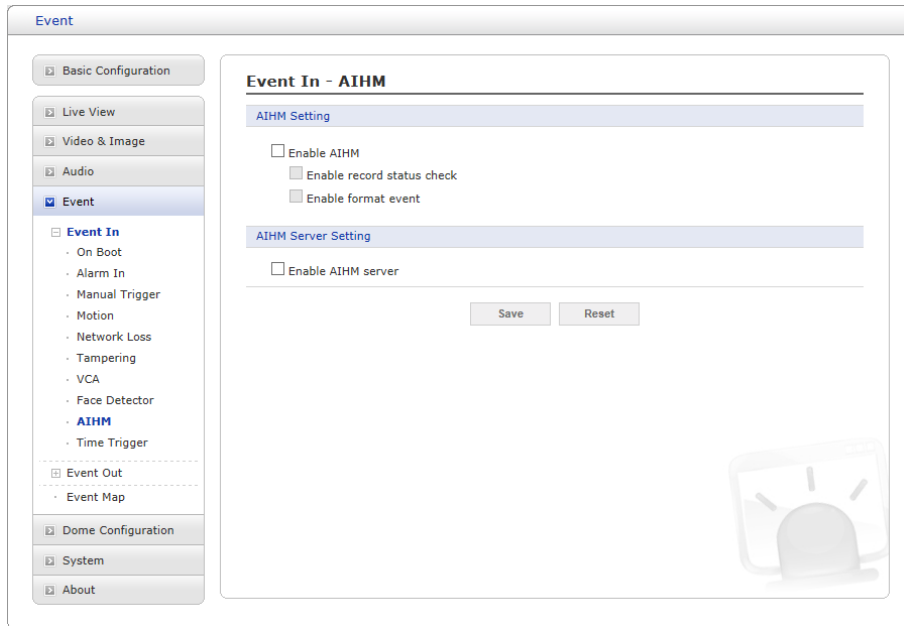

AIHM (Advanced Intelligent Health Monitoring) triggers an event when abnormality of the camera occurs.

- **AIHM Setting:** Select “Enable AIHM” to activate the AIHM function.
 - **Enable record status check:** Trigger event if the record status is modified.
- **AIHM Server Setting:** Select “Enable AIHM server” to send the AIHM event to the AIHM server.

When the settings are complete, click **Save** button to save the settings, or click **Reset** button to clear all of the information you entered without saving it.

▽ Time Trigger

Event

Basic Configuration

Live View

Video & Image

Audio

Event

Event In

- On Boot
- Alarm In
- Manual Trigger
- Motion
- Network Loss
- Tampering
- VCA
- Face Detector
- AIHM
- Time Trigger**

Event Out

- Event Map

Dome Configuration

System

About

Event In - Time Trigger

Time Trigger Setting

Enable time trigger

Trigger 1 Trigger 2 Trigger 3 Trigger 4

Enable time trigger 1

Enable specific time

- Date 2015-11-05

- Time 17 : 46

Enable every day

- Time 17 : 46

Enable day of week

- Day of week THU

- Time 17 : 46

Enable month

- Day 5

- Time 17 : 46

Save Reset

Time Trigger is to set alarms at specific time. User can set up to four time triggers and each time trigger can be set to specific date in the calendar, every day, day of the week, or date of every month.

Select “Enable time trigger” to activate the Time Trigger function.

- **Enable specific time:** User can select type in date and time in the calendar for triggering the event.
- **Enable every day:** Trigger event every day at specified time.
- **Enable day of week:** Trigger event at the day of every week at specified time.
- **Enable month:** Trigger event at the selected date of every month at specified time.

When the settings are complete, click **Save** button to save the settings, or click **Reset** button to clear all of the information you entered without saving it.

2) Event Out

▽ SMTP(E-Mail)

The screenshot shows the configuration interface for SMTP (E-Mail) settings. The left sidebar lists various configuration categories, with 'Event' selected. The main content area is titled 'Event Out - SMTP(E-Mail)' and contains three sections: 'SMTP(E-Mail) Setting', 'SMTP(E-Mail) Receiver', and 'SMTP(E-Mail) Test'. The 'SMTP(E-Mail) Setting' section includes options to enable SMTP, set the sender email address, interval (60 seconds), and aggregate events (60). It also has checkboxes for using a mail server and SMTP authentication, with fields for mail server, port (25), user name, password, and login method (AUTH LOGIN). The 'SMTP(E-Mail) Receiver' section provides eight input fields for email addresses. The 'SMTP(E-Mail) Test' section has a single input field for a receiver and a 'Test' button. At the bottom, there are 'Save' and 'Reset' buttons.

The network camera can be configured to send event and error email messages via SMTP (Simple Mail Transfer Protocol).

- **SMTP (E-Mail) Setting:** Select “Enable” to activate the SMTP operation.
 - **Sender:** Enter an email address to be used as the sender for all messages sent by the network camera.
 - **Interval:** Represents the time interval of the email notification when events occur several times.
 - **Aggregate events:** Shows the maximum number of emails sent within each interval.
 - **Use Mail Server:** Check the box if you are using a mail server to receive event notification and image email.
 - * **Mail Server:** Enter the host names (or IP addresses) for your mail server.
 - * **Port:** Enter the port number for your mail server. Enable the sending of notifications and image email messages from the network camera to predefined addresses via SMTP.
 - **Enable use (SMTP) authentication:** Check the box if your mail server requires authentication.
 - * **User name/Password:** Enter the User name and Password as provided by your network administrator or ISP (Internet Service Provider).
 - * **Login method:** Choose a log-in method in the drop-down list:
AUTH LOGIN / AUTH PLAIN
- **SMTP (E-Mail) Receiver:** User can assign up to 8 receivers.
 - **Receiver #:** Enter an email address.

- **SMTP (E-Mail) Test:** User can check the SMTP setting via a sample email.

- **Receiver:** Enter an email address and click the Test button to test that the mail servers are functioning and that the email address is valid.

When the settings are complete, click **Save** button to save the settings, or click **Reset** button to clear all of the information you entered without saving it.

▽ FTP & JPEG

The screenshot shows the configuration interface for FTP and JPEG settings. The left sidebar contains navigation options like Basic Configuration, Live View, Video & Image, Audio, Event, Dome Configuration, System, and About. The main content area is titled 'Event Out - FTP & JPEG' and is divided into 'FTP Setting' and 'Server 1 JPEG Setting' sections. The 'FTP Setting' section has an 'Enable FTP' checkbox and tabs for Server 1 through Server 4. The 'Server 1 FTP Setting' section includes checkboxes for 'Enable FTP' and 'Passive mode', a 'Port' field (21), 'Remote directory', 'User name', 'Anonymous login' checkbox, 'Password', 'Enable time folder' checkbox, and 'Time type' radio buttons (Day, Hour, Minute). The 'Server 1 JPEG Setting' section includes 'Pre-event', 'Event', and 'Post-event' sections with 'Time' and 'FPS' fields, a 'Prefix file name' field (baseimage_), and 'Additional suffix' radio buttons (Date/Time, Sequence number). 'Save' and 'Reset' buttons are at the bottom.

When the network camera detects an event, it can record and save images to an FTP server. Images can be sent as e-mail attachments. Check the “Enable FTP” box to enable the service. This camera can support multiple FTP servers and user can configure each server settings separately.

• FTP Setting:

- **Server:** Enter the server’s IP address or host name. Note that a DNS server must be specified in the TCP/IP network settings if using a host name.
 - **Passive mode:** Under normal circumstances the network camera simply requests the target FTP server to open the data connection. Checking this box issues a PASV command to the FTP server and establishes a passive FTP connection, whereby the network camera actively initiates both the FTP control and data connections to the target server. This is normally desirable if there is a firewall between the camera and the target FTP server.
 - **Port:** Enter the port number used by the FTP server.
 - **Remote directory:** Specify the path to the directory where the uploaded images will be stored. If this directory does not already exist on the FTP server, there will be an error message when uploading.
 - **User name/Password:** Provide your log-in information.
 - * **Anonymous login:** Check the box if you want to use anonymous login method and the server supports it.
 - **Enable time folder:** To create the folder in the FTP Server.
 - * **Time type:** Create the folder by daily, hourly and every minute.
- NOTE:** Required authority for creating the folder.

• JPEG Setting:

- **Pre-event:** A pre-event buffer contains images from the time immediately preceding the event trigger. These are stored internally in the server. This buffer can be very useful when checking to see what happened to cause the event trigger. Check the box to enable the pre-trigger buffer, enter the desired total length in seconds, minutes or hours, and specify the required image frequency.

- **Event:** This function can set required image frequency (1~2fps) when event detected.
- **Post-event:** This function is the counterpart to the pre-trigger buffer described above and contains images from the time immediately after the trigger. Configure as for pre-event.
- **Prefix file name:** This name will be used for all the image files saved. If suffixes are also used, the file name will take the form <prefix> <suffix>.<extension>.
- **Additional suffix:** Add either a date/time suffix or a sequence number, with or without a maximum value.

When the settings are complete, click **Save** button to save the settings, or click **Reset** button to clear all of the information you entered without saving it.

▽ Alarm Out

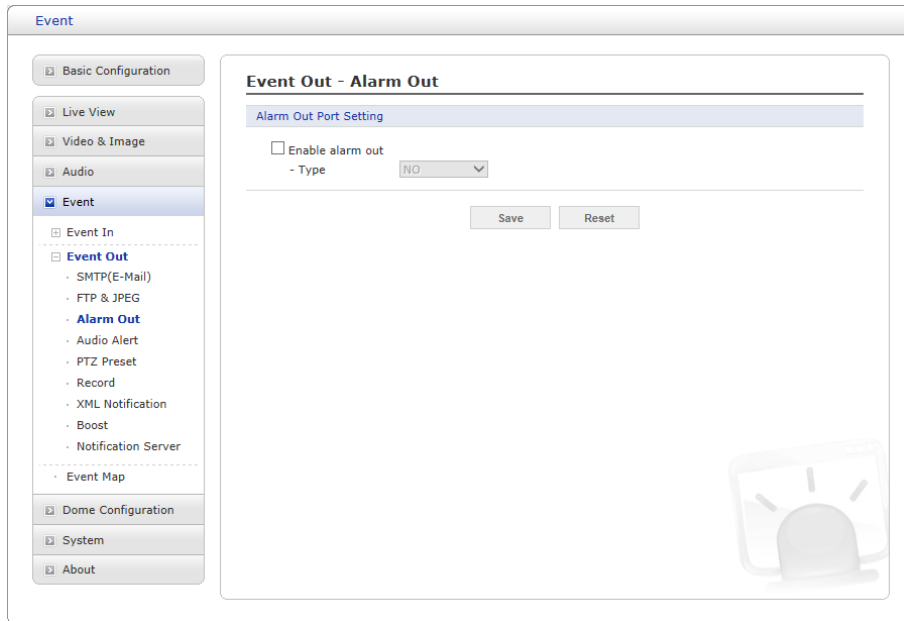

When the network camera detects an event, it can control external equipment connected to its alarm output port.

- **Enable alarm out:** If selected, the output becomes activated for as long as the event is active.
- **Type:** Select a type of NO (Normally Open) or NC (Normally Closed).

When the settings are complete, click **Save** button to save the settings, or click **Reset** button to clear all of the information you entered without saving it.

▽ Audio Alert

The screenshot shows the 'Event Out - Audio Alert' configuration page. The sidebar on the left lists various configuration categories, with 'Event' and 'Event Out' expanded. The 'Event Out' section includes 'Audio Alert' as a sub-option. The main content area is titled 'Event Out - Audio Alert' and contains the following elements:

- Audio Alert Setting:** A checkbox labeled 'Enable audio alert'. Below it are three rows for 'Audio file 1', 'Audio file 2', and 'Audio file 3', each with a 'Browse...' button and an 'Upload' button.
- Audio Alert Test:** A table with columns 'No.', 'File Name', 'File Size', 'Play Time', and 'Bitrate'. Below the table is a note: '* Note: Total file size must be less than 512KB.' and two buttons: 'Test' and 'Remove'.
- Save and Reset:** Two buttons at the bottom of the main content area.

When the network camera detects an event, it can output a predefined audio data to external speaker. Check the “Enable audio alert” box to enable the service.

- **Audio Alert Setting:** To use the audio alert with the network camera, an audio data file made by user must be uploaded from your PC. Provide the path to the file directly, or use the Browse button to locate it. Then click the Upload button. Up to 3 audio files are available. The total file size must be less than 512 KB.
- **Audio Alert Test:** When the setup is complete, the audio output can be tested by clicking the Test button. To remove an audio file, select the file and click the Remove button.

NOTE: For a proper operation of Audio Alert, full duplex must be enabled in the Audio settings page.

When the settings are complete, click **Save** button to save the settings, or click **Reset** button to clear all of the information you entered without saving it.

▽ PTZ Preset

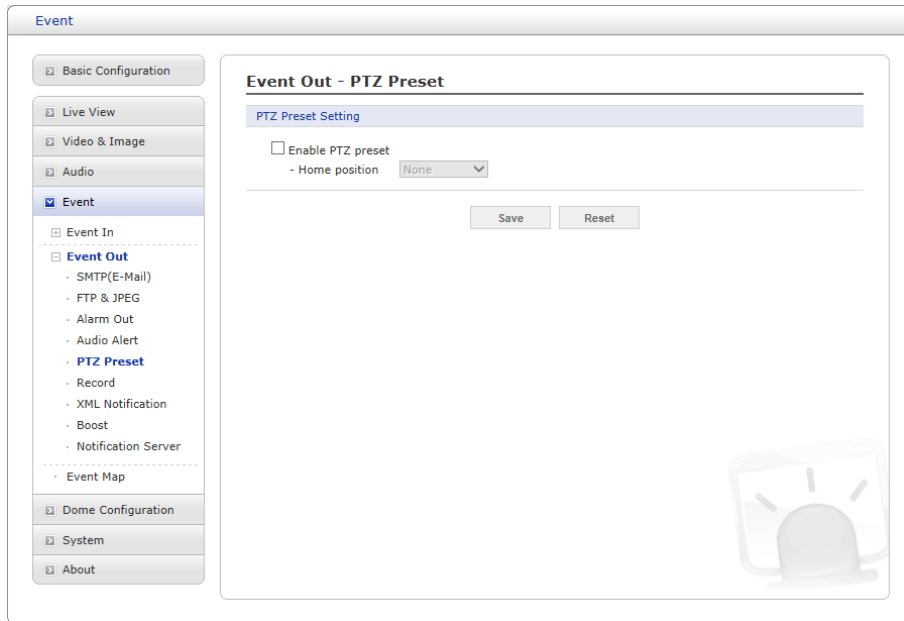

When the camera detects an event, you can move the camera to a predefined preset position. Check the box to enable the service and return to the Home position once the event has ended.

When the settings are complete, click **Save** button to save the settings, or click **Reset** button to clear all of the information you entered without saving it.

▽ Record

Event Out - Record

Record Setting

Enable Record

Overwrite

Continuous Record

* Note : Using continuous recording may shorten life time of SD card.

- Stream Type

- Pre-event [0... 10] sec

- Post-event [0... 60] sec

Audio Record

Record schedule

No Recording Recording

	0	1	2	3	4	5	6	7	8	9	10	11	12	13	14	15	16	17	18	19	20	21	22	23
SUN																								
MON																								
TUE																								
WED																								
THU																								
FRI																								
SAT																								

Device Setting

Device Type

Format

Device Status : No Storage

Device Remove

Device Information

Total	Used	Available	Used Percent	Bad Sector
0.00MB	0.00MB	0.00MB	0.00%	0.00%

When the network camera detects an event, it can record the video stream onto the Micro SD Memory (not supplied) or NAS (Network Attached Device) as a storage device. Check the “Enable Record” box to enable the service.

• Record Setting:

- **Overwrite:** Click checkbox to overwrite the storage device; Continuous Record is available when not using an SD card.
- **Stream Type:** You can select Stream 1, Stream 2, or Stream 3.
 - * **Stream1:** H.264 or MPEG-4 data
 - * **Stream2:** MJPEG data
 - * **Stream3:** H.264 or MPEG-4 data
- **Pre-event:** Enter pre-event time value for the storage device pre-recording.
- **Post-event:** Enter post-event time value for the storage device pre-recording.
- **Record Schedule:** You can set the weekly recording schedule for each day. Drag or click area by a box unit at first. Clicking the block toggles the recording between on and off. Click the All Select button to set a schedule for the entire week or a whole day, respectively.
- **Device Setting:** Select the device type to be recorded in the drop-down list. The screen changes according to selection.
 - **SD:** Mounted SD card.

- **CIFS:** A file format for a NAS device.
- **NFS:** A file format for a NAS device.

NOTE 1: Common Internet File System (CIFS) is a remote file access protocol that forms the basis for Windows file sharing, network printing, and various other network services. CIFS requires a large number of request/response transactions and its performance degrades significantly over high-latency WAN links such as the Internet.

NOTE 2: Network File System (NFS) is a network file system protocol, allowing a user on a client computer to access files over a network in a manner similar to how local storage is accessed. NFS, like many other protocols, builds on the Open Network Computing Remote Procedure Call (ONC RPC) system.

The CIFS screen displays as below.

The screenshot shows a 'Device Setting' form with the following fields and a 'Check' button:

- Device Type:** A dropdown menu with 'CIFS' selected.
- Address:** A text input field.
- Remote directory:** A text input field.
- Capacity:** A text input field containing '0' followed by 'GB'.
- ID:** A text input field.
- Password:** A text input field.
- Check:** A button to validate the entered information.

- **Address:** Enter IP address for NAS device.
- **Remote Directory:** Enter directory or folder location to be recorded in the NAS device.
- **Capacity:** Enter the capacity of storage to be used. This must be less than the total storage capacity.
- **ID/Password:** Enter ID and Password. The network camera will ask for these whenever you access NAS device.
- **Check:** Press the Check button to check the validity of Device Setting data.
- **Format:** Click the Format button to format SD card.
- **Device Information:** Show current SD card information.

When the settings are complete, click **Save** button to save the settings, or click **Reset** button to clear all of the information you entered without saving it.

▽ XML Notification

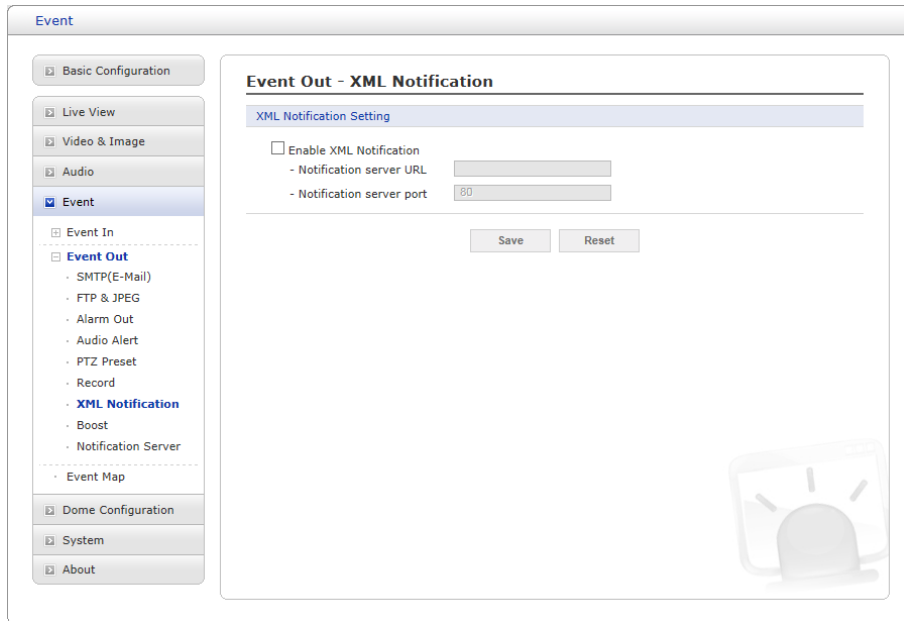

The screenshot shows a web interface for configuring XML notifications. On the left is a navigation menu with categories: Basic Configuration, Live View, Video & Image, Audio, Event (selected), Dome Configuration, System, and About. Under the 'Event' category, there are sub-sections for Event In and Event Out. The 'Event Out' section is expanded to show options like SMTP(E-Mail), FTP & JPEG, Alarm Out, Audio Alert, PTZ Preset, Record, XML Notification (highlighted), Boost, and Notification Server. The main content area is titled 'Event Out - XML Notification' and contains a sub-section 'XML Notification Setting'. It features a checkbox for 'Enable XML Notification'. Below it are two fields: 'Notification server URL' and 'Notification server port' (with a default value of 80). At the bottom of the settings area are 'Save' and 'Reset' buttons. A small icon of a camera is visible in the bottom right corner of the main content area.

When the network camera detects an event, Notification server is used to receive notification messages as a type of XML data format. Check the box to enable the service.

- **XML Notification Setting:**

- **Notification server URL:** The network address to the server and the script that will handle the request.
- **Notification server port:** The port number of the notification server.

When the settings are complete, click **Save** button to save the settings, or click **Reset** button to clear all of the information you entered without saving it.

▽ Boost

Event

Basic Configuration

Live View

Video & Image

Audio

Event

Event In

Event Out

- SMTP(E-Mail)
- FTP & JPEG
- Alarm Out
- Audio Alert
- PTZ Preset
- Record
- XML Notification
- Boost**
- Notification Server

Event Map

Dome Configuration

System

About

Event Out - Boost

Boost Setting

Enable boost

- Boost Stream: Stream 1

	Normal Condition	Boost Condition
Framerate	30	30
Bitrate control	CVBR	
Bitrate	4000 [Kbps]	4000 [Kbps]

Save Reset

The Boost feature is used in conjunction with event detection. When this feature is turned ON, the Frame rate and Bit rate in the boost condition can be set to a different value than the ones in the normal condition field. When an event is detected, the camera will boost the Frame rate and Bit rate from the normal condition to this boosted level for the duration of the event.

Check the box to enable the service.

- **Boost Setting:** You can set the condition in Normal and Boost mode.
 - **Boost Stream:** Select a video stream for each condition in the drop-down list.
 - **Frame rate:** Select a frame refresh rate per second for each condition in the drop-down list.
 - **Bit rate control:** Select VBR or CBR in the drop-down list in Normal Condition. You cannot change it in Boost Condition.
 - **Bit rate:** Select a value for each condition in the drop-down list.

When the settings are complete, click **Save** button to save the settings, or click **Reset** button to clear all of the information you entered without saving it.

▽ Notification Server

The screenshot shows the 'Event Out - Notification Server' configuration page. The sidebar on the left lists various configuration categories, with 'Event Out' expanded to show 'Notification Server' as the selected option. The main panel is titled 'Event Out - Notification Server' and contains two sections: 'Notification Server Setting' and 'Notification Server Test'. The 'Notification Server Setting' section includes a checkbox for 'Enable Notification Server', a dropdown menu for 'Type' (set to 'HTTP'), and input fields for 'URL', 'Port' (set to '80'), 'User name', and 'Password'. The 'Notification Server Test' section has a 'Send message' input field and a 'Test' button. At the bottom, there are 'Save' and 'Reset' buttons. A small icon of a camera is visible in the bottom right corner of the main content area.

When the network camera detects an event, the Notification Server is used to receive uploaded image files and/or notification messages. Check the box to enable the service.

- **Notification Server Setting:**

- **Type:** User can select message transmission type among HTTP, HTTPS, TCP, and UTP.
- **URL:** The network address to the server and the script that will handle the request.
For example: <http://192.168.12.244/cgi-bin/upload.cgi>
- **Port:** The port number of the server.
- **User name/Password:** Provide your log-in information.

- **Notification Server Test:** When the setup is complete, the connection can be tested by clicking the Test button using the contents in “Send message” box.

3) Event Map

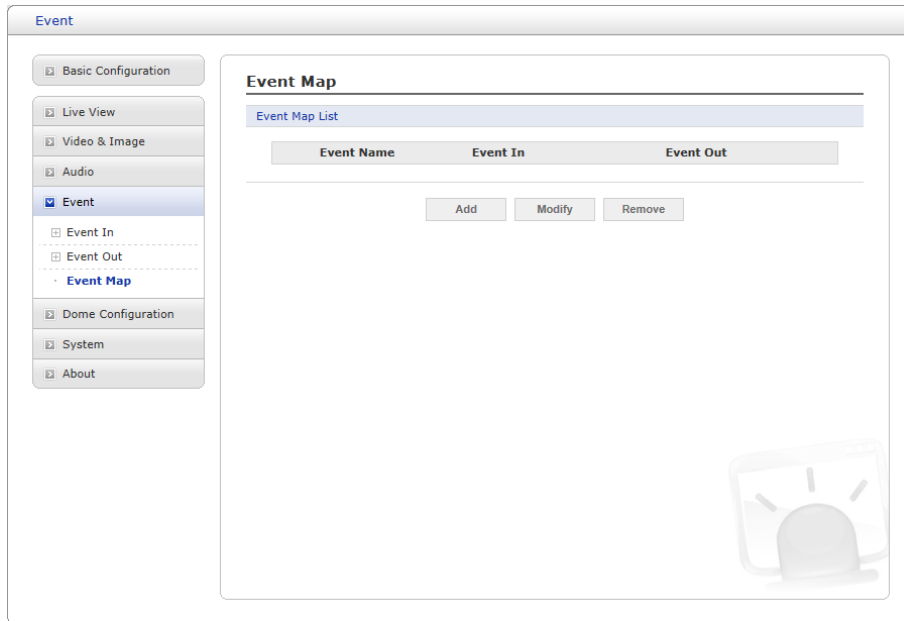

The event map allows you to change the settings and establish a schedule for each event trigger from the network camera; up to a max. 15 events can be registered.

Click the Add button to make a new event map; a popup window displays as below. To change an existing event, select that event and click the Modify button; this same window will display and the information can be changed as required. Selecting an event and clicking Remove deletes the event.

The 'Add Event Map' window is a detailed configuration form. It has a title bar 'Add Event Map' and a 'General' section. The 'Name' field contains 'New Event'. The 'Event In' section has a 'Type' dropdown set to 'Onboot'. The 'Event Out' section includes an 'E-Mail' section with checkboxes for eight email addresses (1-8) and input fields for each. Below this are 'Subject' and 'Additional info' input fields. Other sections include 'FTP' (with checkboxes for FTP Server 1-4), 'Alarm out', 'Audio alert' (with radio buttons for Audio file 1, 2, 3), 'XML Notification', 'Boost', 'PTZ preset' (with a dropdown set to 'preset1' and a checkbox for 'Return to home position after event'), 'Record', and 'Notification Server' (with a 'Message' input field). At the bottom are 'OK' and 'Cancel' buttons.

- **General:** Enter the name for a new event map.
- **Event In:** Select an event type in the drop-down list.
- **Event Out:**
 - **E-mail:** Select the email addresses you want to notify via email that an event has occurred.
 - **FTP:** Select checkbox beside FTP and FTP Servers to record and save images to FTP server when an event has occurred.
 - **Alarm out:** Check this box to enable the alarm out.
 - **Audio Alert:** Select an Audio Alert file as the Network Transmitter output when audio alert event triggered. The Audio Alert file must first be configured on the Event In page.
 - **XML Notification:** It sends XML messages to a Notification server that listens for these. The destination server must first be configured on the Event In page.
 - **Boost:** When an event has occurred, the camera will boost the Frame rate and Bit rate from the normal condition to this boosted level for the duration of the event. Check the box to enable the Function.
 - **PTZ preset:** Select the preset position you want to move at event. If you want to move back to home position after the event, which is pre-defined in the Alarm Out - PTZ Preset page, check “Return to home position after event” box.
 - **Record:** Record video stream when an event has occurred. The Record option must first be configured on the Event Out page.
 - **Notification Server:** It sends notification messages to the notification server that listens for these. The destination server must first be configured on the Event In page. Enter a message you want to send.

When the settings are complete, click **Save** button to save the settings, or click **Reset** button to clear all of the information you entered without saving it.

3.6.6 Configuration (TBD)

1) Preset

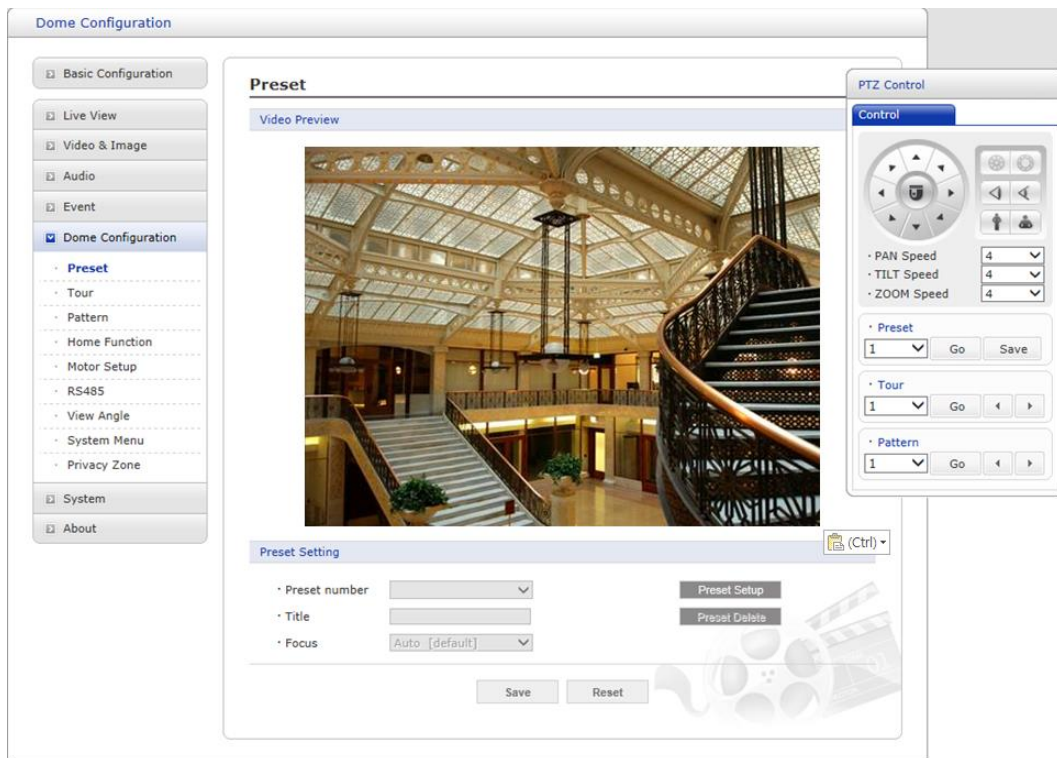

If you need to view specific places routinely, you should program Presets. A Preset is a programmed video scene with automatic pan, tilt, zoom and focus settings. Once programmed, clicking the Preset number or clicking the Go button in the PTZ Control Panel calls up that Preset automatically.

• Preset Setting:

- **Preset number:** The Preset number can be selected in the range 1
- **Title:** Up to 12 characters (Alphanumeric characters and space)
- **Focus:**
 - * **Auto:** Auto Focus is always active.
 - * **Manual:** Auto Focus is inactive.
- **Preset Setup:** Activate the PTZ Control Panel.
- **Preset Delete:** Delete selected Preset number.

Follow steps below to store the Preset positions:

1. Click the **Preset Setup** button, then shows the PTZ Control Panel.
2. Choose the desired Preset number from the Preset drop-down list:
3. After aiming the camera (view direction and lens control) by using the **Arrow** and **Zoom** button in PTZ Control Panel, click the **Save** button.
4. Repeat step 2 through 3 for each additional Preset position.

When the settings are complete, click **Save** button to save the settings, or click **Reset** button to clear all of the information you entered without saving it.

6) RS485

Dome Configuration

Basic Configuration

Live View

Video & Image

Audio

Event

Dome Configuration

Preset

Tour

Pattern

Home Function

Motor Setup

RS485

View Angle

System Menu

Privacy Zone

System

About

RS485

RS485 setting

· DOME ID [1... 3999]

· Protocol

· Baudrate

· Parity

· Dome Answer

Save Reset

• RS485 Setting:

- **DOME ID:** Enter identification number for external PTZ device. The DOME ID can be adjusted in the range 1- 3999.
- **Protocol:** Selects PTZ protocol to communicate with external PTZ device.
- **Baud rate:** Selects one of the Baud rate.
- **Parity:** Selects one of the Parity bit.

When the settings are complete, click **Save** button to save the settings, or click **Reset** button to clear all of the information you entered without saving it.

7) View Angle

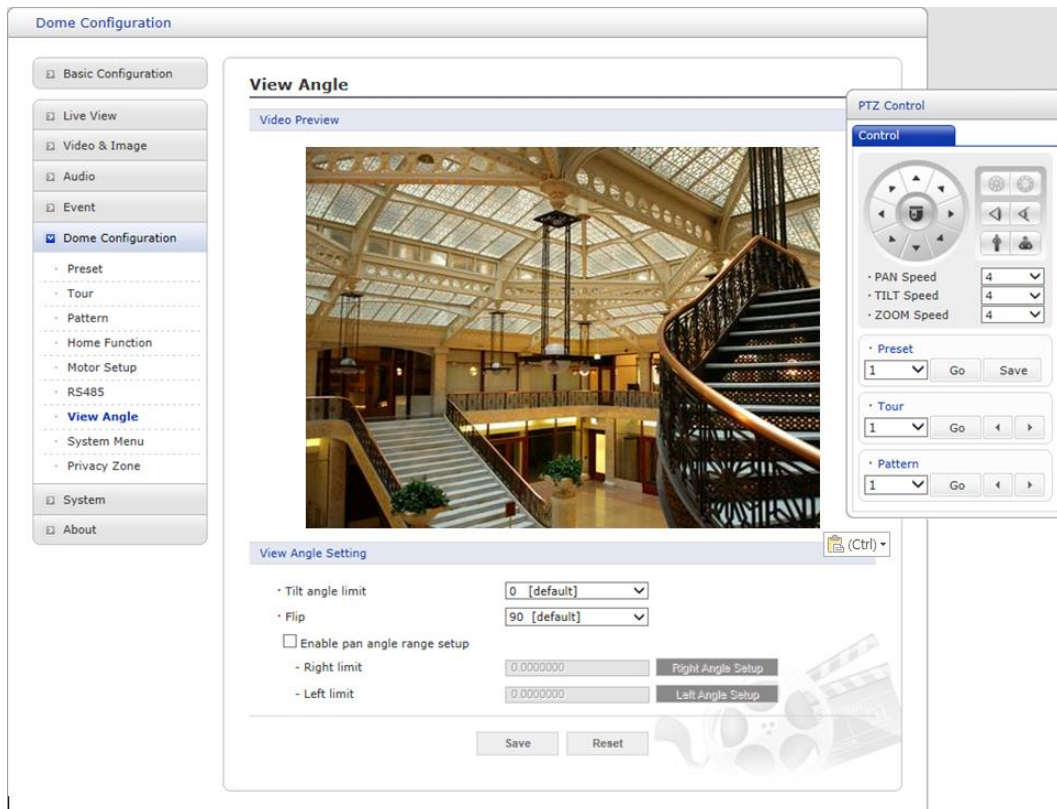

- **View Angle Setting:**

- **Tilt angle limit:** This option is designed to limit the view angle as there is some obstruction in zooming out on specific areas of the tilt angle.

- **Flip:**

- * **Off:** The dome camera moves until 90° vertically.

- * **Auto:** When the camera reaches the floor directly above the moving object, it will stop. At that time, release instantly and pull it down again to run the auto-flip function. When you use the panning range, it is recommended to use the flip mode to Auto.

- * **90, 100, 110, 120:** Allows the image to flip digitally when the camera moves over the setting angle vertically.

- **Enable pan angle range setup:** When the dome camera is installed near a wall, pan angle range can be limited by user.

- * **Right limit:** Select the right limit of pan angle range.

- * **Left limit:** Select the left limit of pan angle range.

When the settings are complete, click **Save** button to save the settings, or click **Reset** button to clear all of the information you entered without saving it.

8) System Menu

The screenshot shows the 'System Menu' configuration page within a 'Dome Configuration' window. On the left is a sidebar menu with options: Basic Configuration, Live View, Video & Image, Audio, Event, Dome Configuration (selected), Preset, Tour, Pattern, Home Function, Motor Setup, RS485, View Angle, System Menu, Privacy Zone, System, and About. The main content area is titled 'System Menu' and contains three sections: 'Dome Information' (Camera type, Dome Hardware Version, Dome Software Version), 'System Menu setting' (Calibration set to 'On'), and 'Origin Check'. The 'Origin Check' section includes a 'Re-arrange the pan and tilt positions.' instruction, an 'Origin Check' button, and a checked 'Enable schedule origin check' option. Below this are three sub-options: 'Enable monthly' (Day: 1st, Time: 00:00), 'Enable weekly' (Day of the week: Sun, Time: 00:00), and 'Enable daily' (Time: 00:00). A 'Camera upgrade' section follows, with instructions to upgrade the camera and a 'Specify the firmware to upgrade' field containing a 'Browse...' button and an 'Upgrade' button. At the bottom are 'Save' and 'Reset' buttons.

- **Information:** The system information provides essential information about the dome if service is required. The information cannot be modified.
- **System Menu setting:** User can set the camera in auto-calibration mode.
- **Origin Check:** If you find the dome in the wrong position during operation, execute this origin check by clicking Origin Check button and the dome camera will return to the right position after the origin check operation.
 - **Enable schedule origin check:** If selected, execute origin check function at scheduled time
 - * **Enable monthly:** Set specific day and time.
 - * **Enable weekly:** Set specific day of the week and time.
 - * **Enable daily:** Set specific time.
- **Camera upgrade:** User can upgrade AF module firmware remotely.

When the settings are complete, click **Save** button to save the settings, or click **Reset** button to clear all of the information you entered without saving it.

9) Privacy Zone (TBD)

The screenshot displays the 'Dome Configuration' software interface. On the left is a navigation menu with options like 'Basic Configuration', 'Live View', 'Video & Image', 'Audio', 'Event', 'Dome Configuration', 'System', and 'About'. The 'Dome Configuration' menu is expanded to show sub-options: 'Preset', 'Tour', 'Pattern', 'Home Function', 'Motor Setup', 'RS485', 'View Angle', 'System Menu', and 'Privacy Zone'. The 'Privacy Zone' option is selected. The main area is titled 'Privacy Zone' and contains a 'Video Preview' window showing a live camera feed of a grand interior space with a large glass dome and a curved staircase. To the right of the video preview is a 'PTZ Control' panel with a 'Control' tab, a directional pad, and speed settings for PAN, TILT, and ZOOM (all set to 4). Below the video preview is a 'Privacy Zone Setting' table with 8 rows, each representing a mask. The table has columns for 'No.', 'Title', 'V.off', 'Set', and 'Delete'. All 'V.off' values are 'Off' and all 'Delete' cells contain an 'X'.

No.	Title	V.off	Set	Delete
1	MASK-1	Off	Set	X
2	MASK-2	Off	Set	X
3	MASK-3	Off	Set	X
4	MASK-4	Off	Set	X
5	MASK-5	Off	Set	X
6	MASK-6	Off	Set	X
7	MASK-7	Off	Set	X
8	MASK-8	Off	Set	X

Using privacy zones (masks), you can hide up to 8 unwanted scenes in a camera. The color of privacy zones is gray.

- **Privacy Zone Setting:** Following steps below to configure the privacy zones;

1. After aiming the camera (view direction and lens control) by using the **Arrow** and **Zoom** button in PTZ Control Panel, click **Set** cell of Set column at any inactive row to create privacy zone.
2. You can change the Title up to 12 alphanumeric characters.
3. In order to hide or display the privacy zone, choose On or Off in V.off column.
4. Click **X** at Delete column to delete privacy zone.

When the settings are complete, click **Save** button to save the settings, or click **Reset** button to clear all of the information you entered without saving it.

3.6.7 System

1) Information

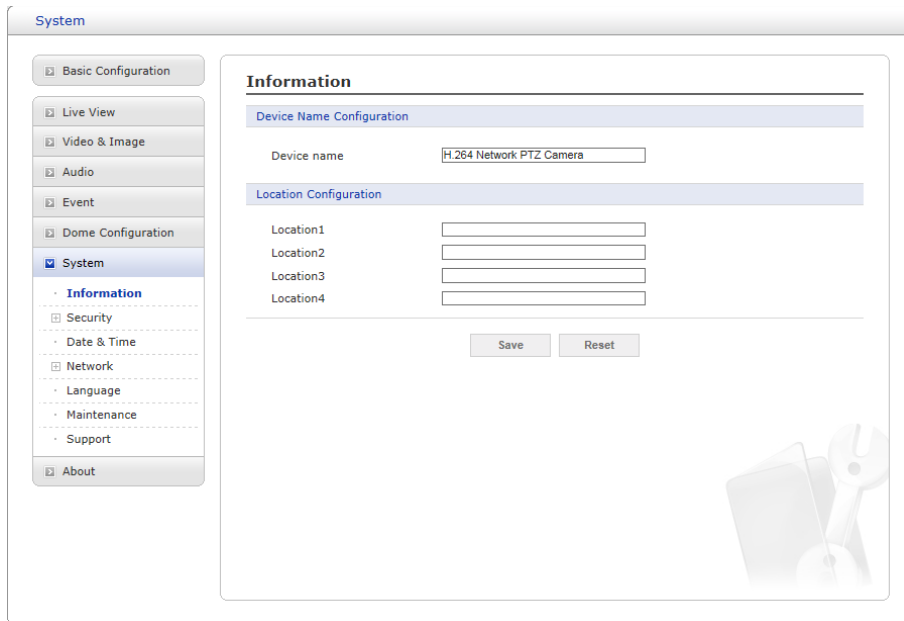

The screenshot shows a web interface for system configuration. On the left is a sidebar menu with the following items: Basic Configuration, Live View, Video & Image, Audio, Event, Dome Configuration, System (selected), Information, Security, Date & Time, Network, Language, Maintenance, Support, and About. The main content area is titled 'System' and contains an 'Information' section. This section is divided into two parts: 'Device Name Configuration' and 'Location Configuration'. Under 'Device Name Configuration', there is a 'Device name' label and a text input field containing 'H.264 Network PTZ Camera'. Under 'Location Configuration', there are four labels: 'Location1', 'Location2', 'Location3', and 'Location4', each followed by an empty text input field. At the bottom of the main content area, there are two buttons: 'Save' and 'Reset'. A faint watermark of a laptop and a wrench is visible in the bottom right corner of the interface.

You can enter the system information. This page is very useful when you require device information after installation.

- **Device Name Configuration:** Enter the device name.
- **Location Configuration:** Enter the location information. You can enter up to four locations.

When the settings are complete, click **Save** button to save the settings, or click **Reset** button to clear all of the information you entered without saving it.

2) Security

▽ Users

User Name	User Group	Authority
admin	administrator	live, setup, system, ptz

User access control is enabled by default when the administrator sets the root password on first access. New users are authorized with user names and passwords, or the administrator can choose to allow anonymous viewer login to the Live View page, as described below:

- **User Setting:** Check the box to enable anonymous viewer login to the network camera without a user account. When using the user account, users have to log-in at every access.
- **User List Setting:** This section shows how to register a user account. Enter a user name and password to be added, and register them by pressing the Add button. You will see the pop-up window as below.

· User name :

· Password :

· Confirm password :

· User group :

Enable PTZ control

When the settings are complete, click **Save** button to save the settings, or click **Reset** button to clear all of the information you entered without saving it.

▽ HTTPS

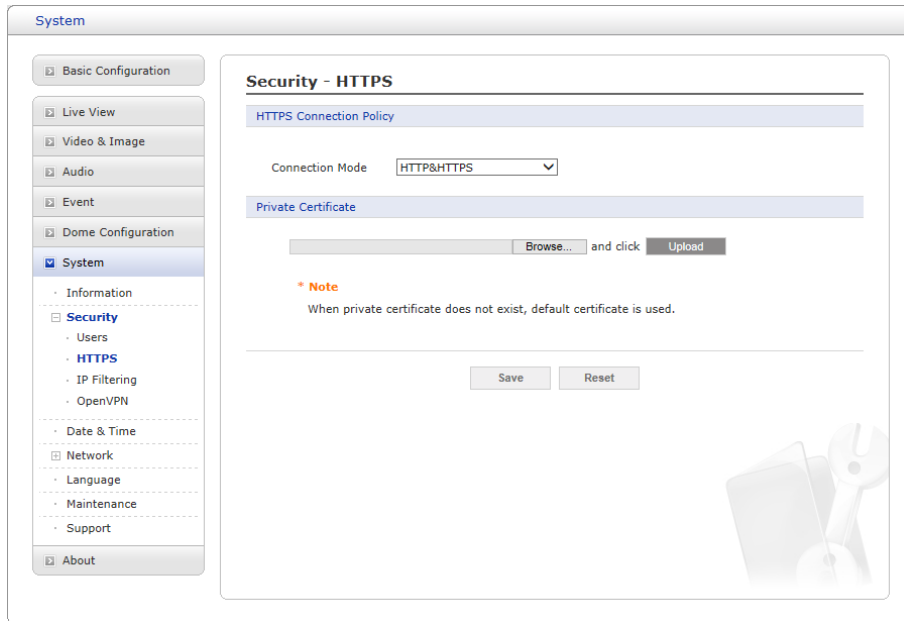

For greater security, the network camera can be configured to use HTTPS (Hypertext Transfer Protocol over SSL (Secure Socket Layer)). Then all communication that would otherwise go via HTTP will instead go via an encrypted HTTPS connection.

- **HTTPS Connection Policy:** Choose the form of connection you wish to use from the drop-down list for the administrator, Operator and Viewer to enable HTTPS connection (set to HTTP by default).
 - HTTP
 - HTTPS
 - HTTP & HTTPS
- **Upload Certificate:** To use HTTPS for communication with the network camera, an official certificate issued by a CA (Certificate Authority) must be uploaded from your PC. Provide the path to the certificate directly, or use the **Browse** button to locate it. Then click the **Upload** button.

Please refer to the home page of your preferred CA for information on where to send the request. For more information, please see the online help.

When the settings are complete, click **Save** button to save the settings, or click **Reset** button to clear all of the information you entered without saving it.

▽ IP Filtering

The screenshot shows a web-based configuration interface for a system. On the left is a navigation menu with categories like Basic Configuration, Live View, Video & Image, Audio, Event, Dome Configuration, System (selected), Information, Security (with sub-items Users, HTTPS, IP Filtering, OpenVPN), Date & Time, Network, Language, Maintenance, Support, and About. The main content area is titled 'Security - IP Filtering' and contains an 'IP Filtering Setting' section. At the top of this section is a checkbox labeled 'Enable IP filtering'. Below it is a table with five rows, each representing a filter entry. The columns are 'On/Off', 'Priority', 'Policy', 'Start IP', and 'End IP'. All 'On/Off' checkboxes are unchecked, and all 'Policy' dropdowns are set to 'ALLOW'. The 'Start IP' and 'End IP' fields are currently empty, showing '0 . 0 . 0 . 0'. At the bottom of the table are 'Save' and 'Reset' buttons. A faint watermark of a laptop and a wrench is visible in the bottom right corner of the interface.

On/Off	Priority	Policy	Start IP	End IP
<input type="checkbox"/>	1	ALLOW	0 . 0 . 0 . 0	0 . 0 . 0 . 0
<input type="checkbox"/>	2	ALLOW	0 . 0 . 0 . 0	0 . 0 . 0 . 0
<input type="checkbox"/>	3	ALLOW	0 . 0 . 0 . 0	0 . 0 . 0 . 0
<input type="checkbox"/>	4	ALLOW	0 . 0 . 0 . 0	0 . 0 . 0 . 0
<input type="checkbox"/>	5	ALLOW	0 . 0 . 0 . 0	0 . 0 . 0 . 0

Checking the **Enable IP address filtering** box enables the IP address filtering function. Up to 256 IP address entries may be specified (a single entry can contain multiple IP addresses). Click the **Add** button to add new filtered addresses.

When the IP address filter is enabled, addresses added to the list are set as allowed or denied addresses. All other IP addresses not in this list will then be allowed or denied access accordingly, that is, if the addresses in the list are allowed, then all others are denied access, and vice versa. Also see the online help for more information.

NOTE: Users from IP addresses that will be allowed must also be registered with the appropriate access rights. This is done from Setup > System > Security > Users.

When the settings are complete, click **Save** button to save the settings, or click **Reset** button to clear all of the information you entered without saving it.

▽ OpenVPN

The screenshot shows the 'Security - OpenVPN' configuration page. The left sidebar is expanded to 'System', which includes 'OpenVPN'. The main panel has two sections: 'OpenVPN Configuration' and 'Server Mode Configuration'. Under 'OpenVPN Configuration', 'Enable openVPN' is checked, 'Server mode' is selected, and the IP address is '0.0.0.0'. Under 'Server Mode Configuration', 'Protocol type' is 'UDP', 'Internal IP' is '10.8.0.1', 'Subnet Mask' is '255.255.255.0', 'Port' is '1194', and 'Renegotiation time' is '3600'. There are also checkboxes for 'Use LZO compression' and 'Export CA certificate' with a 'Download' button. 'Save' and 'Reset' buttons are at the bottom.

OpenVPN is a Virtual Private Network using OpenSSL authentication. User can set the camera in either Server mode or Client mode.

• OpenVPN Server Mode

1. Select Enable OpenVPN activates mode selection buttons. Choose Server mode, then Server Mode Configuration appears where you can configure Server Mode Settings.
2. In Server Mode Configuration, you can setup Protocol type, Port number, LZO compression usage, and Renegotiation time, as well as download Server certificate file.
 - Choose Protocol type between UDP and TCP, UDP is preferred. Type in Port number you want to use, default is 1194.
 - Default Renegotiation time is 3600 seconds, and 0 means no verification.
 - “Use LZO compression” determines whether to use cypher compression in connection or not.
 - CA certificate is the certification file issued by Server for Client setup.
3. After finishing setup, click Save button and then the camera operates as an OpenVPN Server.

• OpenVPN Client Mode

1. Select Enable OpenVPN activates mode selection buttons. Choose Client mode, then Client Mode Configuration appears where you can configure Client Mode Settings.
2. In Client Mode Configuration, you can setup Server URL, Protocol type, Port number, LZO usage, and Renegotiation time.
 - Server URL sets OpenVPN IP address.
 - Protocol type, Port number, and LZO setting must match Server setting.
 - Default Renegotiation time is 3600 seconds, and 0 means no verification.
 - Upload CA certificate issued by Server.
3. Select authentication method between User authentication and Machine authentication.
 - For Machine authentication, upload client certificate and client key provided by Server.
 - For User authentication, type in registered ID and Password.
4. After finishing setup, click Save button and then the camera operates as an OpenVPN Client.

When the settings are complete, click **Save** button to save the settings, or click **Reset** button to clear all of the information you entered without saving it.

3) Date & Time

The screenshot shows a web interface for configuring the system's date and time. On the left is a navigation menu with categories like Basic Configuration, Live View, Video & Image, Audio, Event, Dome Configuration, System (selected), Information, Security, Date & Time, Network, Language, Maintenance, Support, and About. The main content area is titled 'Date & Time' and is divided into three sections: 'Current Server Time', 'New Server Time', and 'Date & Time Format'. The 'Current Server Time' section shows the current date as 2015-12-10 and time as 14:21:12. The 'New Server Time' section allows setting a new time zone (currently '(GMT) Greenwich Mean Time : Dublin, Edinburgh, Lisbon, London'), a checkbox for 'Automatically adjusts for daylight saving time changes', and three time mode options: 'Synchronize with computer time' (selected), 'Synchronize with NTP server' (with NTP server 'time.nist.gov' and interval '12' hours), and 'Set manually' (with date '2015-12-10' and time '14:21:01'). The 'Date & Time Format' section has dropdown menus for 'Date Format' (set to 'YYYY-MM-DD') and 'Time Format' (set to '24 Hour'). At the bottom are 'Save' and 'Reset' buttons.

- **Current Server Time:** This displays the current date and time (24h clock). The time can be displayed in 12h clock format (see below).
- **New Server Time:**
 - **Time zone:** Select your time zone from the drop-down list. If you want the server clock to automatically adjust for daylight savings time, check the box “Automatically adjust for daylight saving time changes”.
 - **Time mode:** Select the preferred method to use for setting the time:
 - * **Synchronize with computer time:** Sets the time from the clock on your computer.
 - * **Synchronize with NTP Server:** The network camera will obtain the time from an NTP server every 60 minutes.
 - * **Set manually:** Allows you to manually set the time and date.
- **Date & Time Format:** Specify the formats for the date and time (12h or 24h) displayed in the video streams. Select Date & Time format from the drop-down list.
 - **Date Format:** Specify the date format. YYYY: Year, MM: Month, DD: Day
 - **Time Format:** Specify the date format. 24 Hours or 12 Hours

NOTE: If using a host name for the NTP server, a DNS server must be configured under TCP/IP settings.

When the settings are complete, click **Save** button to save the settings, or click **Reset** button to clear all of the information you entered without saving it.

4) Network

▽ Basic

The screenshot shows the 'Network - Basic' configuration page. The sidebar on the left is expanded to 'System' > 'Network' > 'Basic'. The main content area is titled 'Network - Basic' and contains the following sections:

- IP Address Configuration:** Radio buttons for 'Obtain IP address via DHCP' (selected) and 'Use the following IP address :'. Fields for IP address (192 . 168 . 30 . 220), Subnet mask (255 . 255 . 255 . 0), and Default router (192 . 168 . 30 . 1).
- IPv6 Address Configuration:** Checkbox for 'Enable IPv6' (unchecked) and a field for 'IPv6 address : fe80::207:d8ff:fe18:dd16/64'.
- DNS Configuration:** Radio buttons for 'Obtain DNS server via DHCP' (selected) and 'Use the following DNS server address :'. Fields for Domain name, Primary DNS server (168 . 126 . 63 . 1), and Secondary DNS server (0 . 0 . 0 . 0).
- Host Name Configuration:** Field for 'Host Name' (IP.Camera007D818DD16).
- Services:** Fields for 'HTTP port' (80), 'HTTPS port' (443), and 'RTSP port' (554).
- ARP/Ping Setting:** Checkbox for 'Enable ARP/Ping setting' (checked).
- Link Speed Control:** Dropdowns for 'LAN Interface' (Auto) and 'Link Speed' (100M) bit/sec.

At the bottom right, there are 'Save' and 'Reset' buttons.

• IP Address Configuration:

- **Obtain IP address via DHCP:** Dynamic Host Configuration Protocol (DHCP) is a protocol that lets network administrators centrally manage and automate the assignment of IP addresses on a network. DHCP is enabled by default. Although a DHCP server is mostly used to set an IP address dynamically, it is also possible to use it to set a static, known IP address for a particular MAC address. To obtain IP address via DHCP, check the radio button.
- **Use the following IP address:** To use a static IP address for the network camera, check the radio button and then make the following settings:
 - * **IP address:** Specify a unique IP address for your network camera.
 - * **Subnet mask:** Specify the mask for the subnet the network camera is located on.
 - * **Default router:** Specify the IP address of the default router (gateway) used for connecting devices attached to different networks and network segments.

- **IPv6 Address Configuration:** Check this “Enable IPv6” box to enable IPv6. Other settings for IPv6 are configured in the network router.

- **DNS Configuration:** DNS (Domain Name Service) provides the translation of host names to IP addresses on your network. Check the radio button to obtain DNS server via DHCP or set the DNS server.

- **Obtain DNS Server via DHCP:** Automatically use the DNS server settings provided by the DHCP server.
- **Use the following DNS server address** to enter the desired DNS server by specifying the following:
 - * **Domain name:** Enter the domain(s) to search for the host name used by the network camera. Multiple domains can be separated by semicolons (;). The host name is always the first part of a Fully Qualified Domain Name, for example, my server is the host name in the Fully Qualified Domain Name myserver.mycompany.com where mycompany.com is the Domain name.
 - * **DNS servers:** Enter the IP addresses of the primary and secondary DNS servers.
- **Host Name Configuration:**
 - **Host Name:** Enter the host name to be used as device information in the client software or SmartManager.
- **Services:**
 - **HTTP port:** Enter a port to receive a service through the HTTP. Default port number is “80”.
 - **HTTPS port:** Enter a port to receive a service through the HTTPS. Default port number is “443”.
 - **RTSP port:** Enter a port to receive a service through the RTSP. Default port number is “554”.
- **ARP/Ping Setting:**
 - **Enable ARP/Ping setting:** The IP address can be set using the ARP/Ping method, which associates the unit’s MAC address with an IP address. Check this box to enable the service. Leave disabled to prevent unintentional resetting of the IP address.
- **Link Speed Control:**
 - **Link Speed:** User can select either 10Mbps or 100Mbps.

When the settings are complete, click **Save** button to save the settings, or click **Reset** button to clear all of the information you entered without saving it.

▽ DDNS

The screenshot shows the 'Network - DDNS' configuration page. The sidebar on the left lists various system settings, with 'System' and 'Network' expanded. The 'Network' section includes 'Basic', 'DDNS', 'RTP', 'UPnP', 'QoS', 'NAT', 'Zeroconf', 'Bonjour', 'Language', 'Maintenance', 'Support', and 'About'. The main content area is titled 'Internet DDNS (Dynamic Domain Name Service)'. It features a checkbox for 'Enable DDNS'. Below this is a note: '* Note: Please remember you have to configure at least primary DNS server in DNS configuration settings to use Dynamic DNS.' The configuration fields include: 'DDNS Server' (a dropdown menu with 'cctv-network.co.kr' selected), 'Registered host' (a text input field), 'User name' (a text input field), 'Password' (a text input field), 'Confirm password' (a text input field), and 'Maximum time interval' (a dropdown menu with '1 hour' selected). There is also a checkbox for 'Register local network IP address' and a 'Registered IP address' field. At the bottom of the form are 'Save' and 'Reset' buttons.

- **Internet DDNS (Dynamic Domain Name Service):** When using the high-speed Internet with the telephone or cable network, users can operate the network camera on the floating IP environment in which IPs are changed at every access. Users should receive an account and password by visiting a DDNS service like <http://www.dyndns.com/>.
- **Enable DDNS:** Check to have DDNS service available.
 - * **DDNS Server:** Select the DDNS server.
 - * **Registered host:** Enter an address of the DDNS server.
 - * **Username:** Enter an ID to access to the DDNS server.
 - * **Password:** Enter a password to be used for accessing the DDNS server.
 - * **Confirm:** Enter the password again to confirm it.
 - * **Maximum time interval:** Set a time interval to synchronize with the DDNS server. Select the time interval from the drop-down list.
 - * **Register local network IP address:** Register a Network Video Server IP address to the DDNS server by checking the box and enter the Registered IP address.

When the settings are complete, click **Save** button to save the settings, or click **Reset** button to clear all of the information you entered without saving it.

▽ RTP

The screenshot shows the 'Network - RTP' configuration page. On the left is a navigation menu with categories like Basic Configuration, Live View, Video & Image, Audio, Event, Dome Configuration, System, Information, Security, Date & Time, Network (Basic, DDNS, RTP, UPnP, QoS, NAT, Zeroconf, Bonjour), Language, Maintenance, Support, and About. The main content area is titled 'Network - RTP' and contains several sections:

- Port Range:** Start port (30000) and End port (30199).
- Multicast (Stream 1):** Multicast destination IP (231.1.128.20), RTP port (40000), RTP TTL (1), and an unchecked 'Always enable multicast' checkbox.
- Multicast (Stream 2):** Multicast destination IP (231.1.128.21), RTP port (40000), RTP TTL (1), and an unchecked 'Always enable multicast' checkbox.
- Multicast (Stream 3):** Multicast destination IP (231.1.128.22), RTP port (40000), RTP TTL (1), and an unchecked 'Always enable multicast' checkbox.
- Multicast (Audio):** Multicast destination IP (231.1.128.20), RTP port (40002), RTP TTL (1), and an unchecked 'Always enable multicast' checkbox.
- Multicast (Meta):** Multicast destination IP (231.1.128.20), RTP port (40004), RTP TTL (1), and an unchecked 'Always enable multicast' checkbox.

At the bottom right, there are 'Save' and 'Reset' buttons.

Create a setting for sending and receiving an audio or video on a real-time basis. These settings are the IP address, port number, and Time-To-Live value (TTL) to use for the media stream(s) in multicast H.264 format. Only certain IP addresses and port numbers should be used for multicast streams.

- **Port Range:**

- **Start/End port:** Enter a value between 1024 and 65532.

- **Multicast (Stream1/Stream2/Stream3/Audio/Meta):** This function is for sending Video, Audio, and Meta Data to Multicast group.

- **Enable Multicast:** Check the box to enable multicast operation.

- **Multicast destination IP:** Enter an IP between 224.0.0.0 and 239.255.255.255.

- **RTP port:** Enter a value between 1024 and 65532.

- **RTP TTL:** Enter a value between 1 and 255. If a network status is smooth, enter a lower value. However, if a network status is poor, enter a higher value. When there are many network cameras or users, a higher value may cause a heavy load to the network. Consult with a network manager for detailed information.

- **Always enable multicast:** Check the box to start multicast streaming without opening an RTSP session.

When the settings are complete, click **Save** button to save the settings, or click **Reset** button to clear all of the information you entered without saving it.

▽ UPnP

The screenshot shows a web interface for configuring UPnP. On the left is a navigation menu with categories like Basic Configuration, Live View, Video & Image, Audio, Event, Dome Configuration, System (selected), Information, Security, Date & Time, Network (with sub-items: Basic, DDNS, RTP, UPnP, QoS, NAT, Zeroconf, Bonjour), Language, Maintenance, Support, and About. The main content area is titled 'Network - UPnP' and contains a 'UPnP Configuration' section. It features a checked checkbox for 'Enable UPnP' and a text field for 'Friendly name' containing 'IP Camera-0007D818DD16'. At the bottom of this section are 'Save' and 'Reset' buttons. A faint watermark of a laptop and a wrench is visible in the bottom right corner of the main content area.

The network camera includes support for UPnP. UPnP is enabled by default, so the network camera is automatically detected by operating systems and clients that support this protocol.

Enter a name in the Friendly name field.

NOTE: UPnP must be installed on your workstation if running Windows XP. To do this, open the Control Panel from the Start Menu and select Add/Remove Programs. Select Add/Remove Windows Components and open the Networking Services section. Click Details and then select UPnP as the service to add.

When the settings are complete, click **Save** button to save the settings, or click **Reset** button to clear all of the information you entered without saving it.

▽ QoS

The screenshot shows a web interface for configuring Quality of Service (QoS) settings. The interface is titled 'System' and has a sidebar with various configuration categories. The main content area is titled 'Network - QoS' and contains two sections: 'DSCP Setting' and 'Automatic Traffic Control'. The 'DSCP Setting' section has three input fields: 'Live stream DSCP' (0), 'Event/Alarm DSCP' (0), and 'Management DSCP' (0), each with a range of [0... 63]. The 'Automatic Traffic Control' section has a checkbox for 'Enable automatic traffic control' which is unchecked. Below it, there are two radio buttons: 'Maximum bandwidth' (selected) and 'Automatic framerate control'. The 'Maximum bandwidth' section has a dropdown menu for 'Mbit/s' and a 'Priority' dropdown menu for 'Framerate'. There are 'Save' and 'Reset' buttons at the bottom right of the configuration area.

Quality of Service (QoS) provides the means to guarantee a certain level of a specified resource to selected traffic on a network. Quality can be defined as a maintained level of bandwidth, low latency, and no packet losses.

The main benefits of a QoS-aware network are:

1. The ability to prioritize traffic and thus allow critical flows to be served before flows with lesser priority.
 2. Greater reliability in the network, due to the control of the amount of bandwidth an application may use, and thus control over bandwidth races between applications.
- **DSCP Settings:** For each type of network traffic supported by your network video product, enter a DSCP (Differentiated Services Code Point) value. This value is used to mark the traffic's IP header. When the marked traffic reaches a network router or switch, the DSCP value in the IP header tells the router or switch which type of treatment to apply to this type of traffic, for example, how much bandwidth to reserve for it. Note that DSCP values can be entered in decimal or hex form, but saved values are always shown in decimal.

The following types of traffic are marked; enter a value for each type of traffic used:

- **Live Stream DSCP**
- **Event/Alarm DSCP**
- **Management DSCP**
- **Automatic Traffic Control:** Check the box to enable automatic traffic control. Set a limitation on user network resources by designating the maximum bandwidth. Select either the Maximum bandwidth or Automatic framerate radio button.
 - **Maximum bandwidth:** When sharing other network programs or equipment, it is possible to set a limitation on the maximum bandwidth in the unit of Mbit/s or kbit/s.
 - **Automatic frame rate:** Selected if not influenced by a network-related program or equipment without a limitation on the network bandwidth.

When the settings are complete, click **Save** button to save the settings, or click **Reset** button to clear all of the information you entered without saving it.

▽ NAT (Port Mapping)

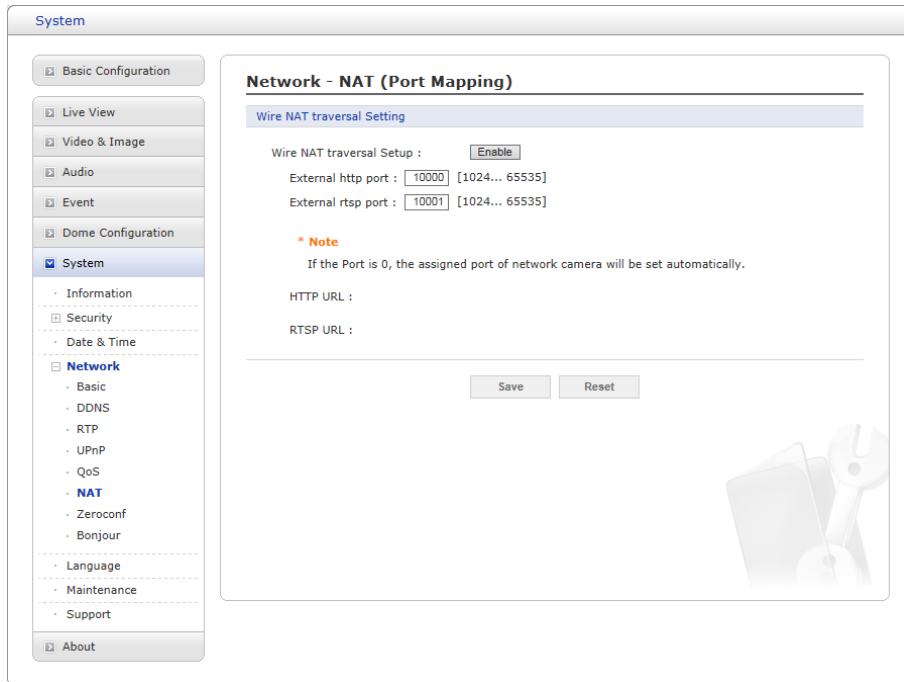

A broadband router allows devices on a private network (LAN) to share a single connection to the Internet. This is done by forwarding network traffic from the private network to the outside, that is, the Internet. Security on the private network (LAN) is increased since most broadband routers are pre-configured to stop attempts to access the private network (LAN) from the public network/Internet.

Use NAT traversal when your network cameras are located on an intranet (LAN) and you wish to make it available from the other (WAN) side of a NAT router. With NAT traversal properly configured, all HTTP traffic to an external HTTP port in the NAT router is forwarded to the network camera.

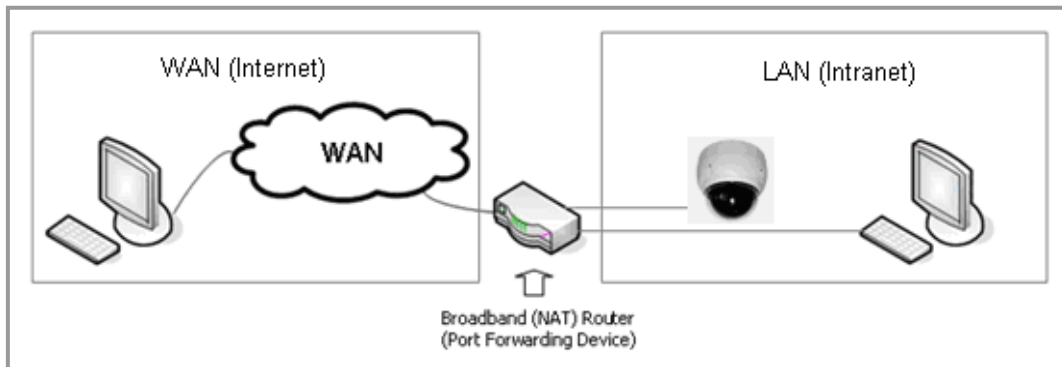

NOTES:

- For NAT (port mapping) to work, this must be supported by the broadband router.
- The broadband router has many different names: "NAT router", "Network router", "Internet Gateway", "Broadband sharing device" or "Home firewall", but the essential purpose of the device is the same.

When the settings are complete, click **Save** button to save the settings, or click **Reset** button to clear all of the information you entered without saving it.

▽ Zeroconf

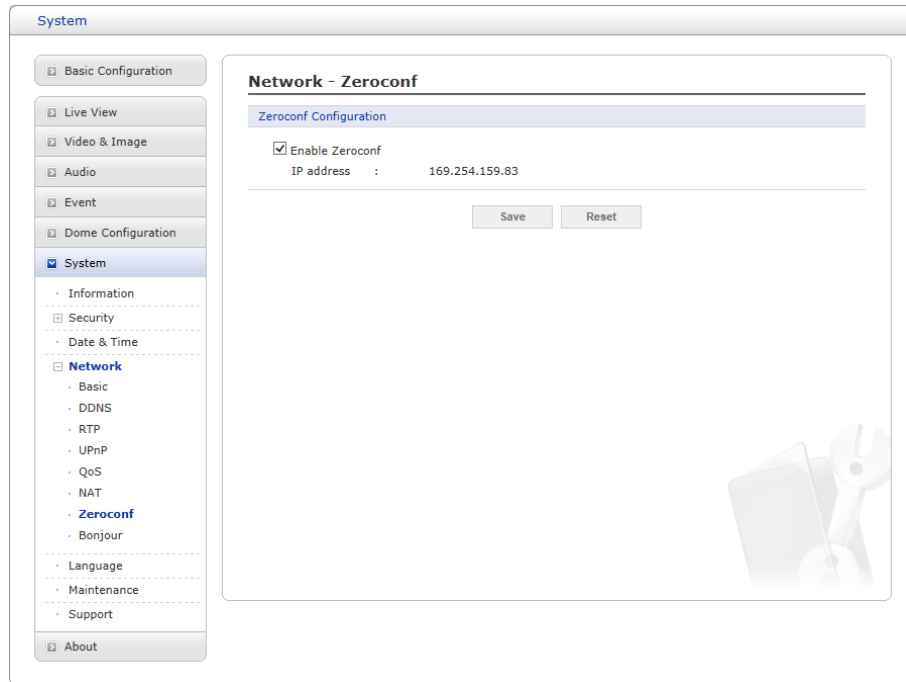

Zero configuration networking (Zeroconf) is a set of techniques that automatically creates a usable Internet Protocol (IP) network without manual operator intervention or special configuration servers.

Zero configuration networking allows devices such as computers and printers to connect to a network automatically. Without Zeroconf, a network administrator must set up services, such as Dynamic Host Configuration Protocol (DHCP) and Domain Name System (DNS), or configure each computer's network settings manually, which may be difficult and time-consuming.

Zeroconf is built on three core technologies:

- Assignment of numeric network addresses for networked devices (link-local address auto configuration)
- Automatic resolution and distribution of computer hostnames (multicast DNS)
- Automatic location of network services, such as printing devices through DNS service discovery.

Click the checkbox to enable Zeroconf.

When the settings are complete, click **Save** button to save the settings, or click **Reset** button to clear all of the information you entered without saving it.

▽ Bonjour

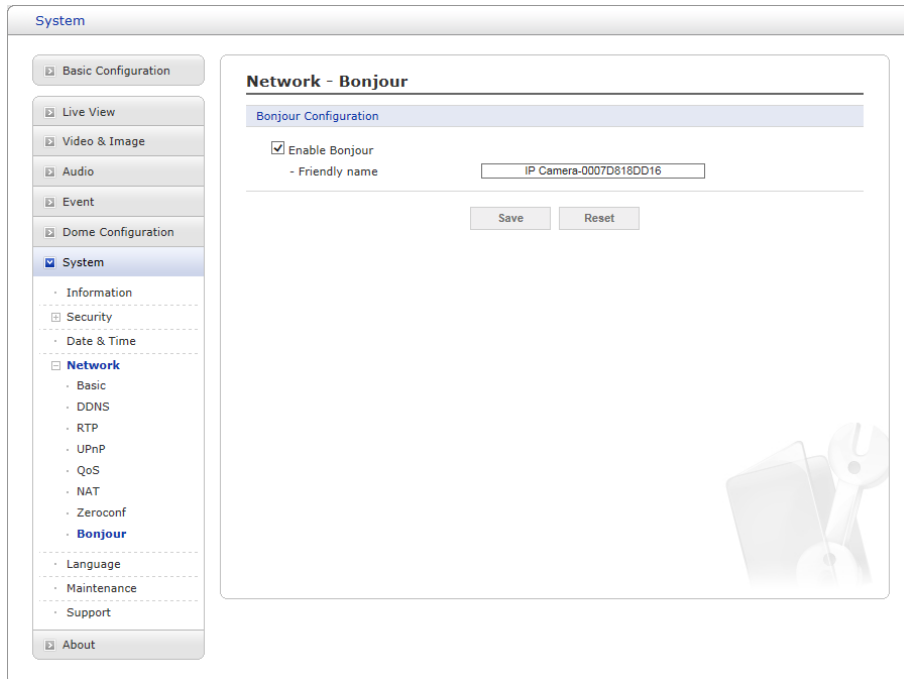

The screenshot shows a web interface for configuring a network camera. On the left is a navigation menu with categories like Basic Configuration, Live View, Video & Image, Audio, Event, Dome Configuration, System, Network, Language, Maintenance, Support, and About. The 'System' category is selected, and the 'Network - Bonjour' page is displayed. The page has a sub-header 'Bonjour Configuration' and contains a checked checkbox for 'Enable Bonjour'. Below it is a text field for 'Friendly name' containing the value 'IP Camera-0007D818DD16'. At the bottom of the configuration area are 'Save' and 'Reset' buttons. A faint watermark of a camera and tools is visible in the bottom right corner of the page content.

The network camera includes support for Bonjour. When enabled, the network camera is automatically detected by operating systems and clients that support this protocol.

Click the check box to enable Bonjour. Enter a name in the Friendly name field.

NOTE: Also known as zero-configuration networking, Bonjour enables devices to automatically discover each other on a network, without having to enter IP addresses or configure DNS servers. (Bonjour is a trademark of Apple Computer, Inc.)

When the settings are complete, click **Save** button to save the settings, or click **Reset** button to clear all of the information you entered without saving it.

5) Language

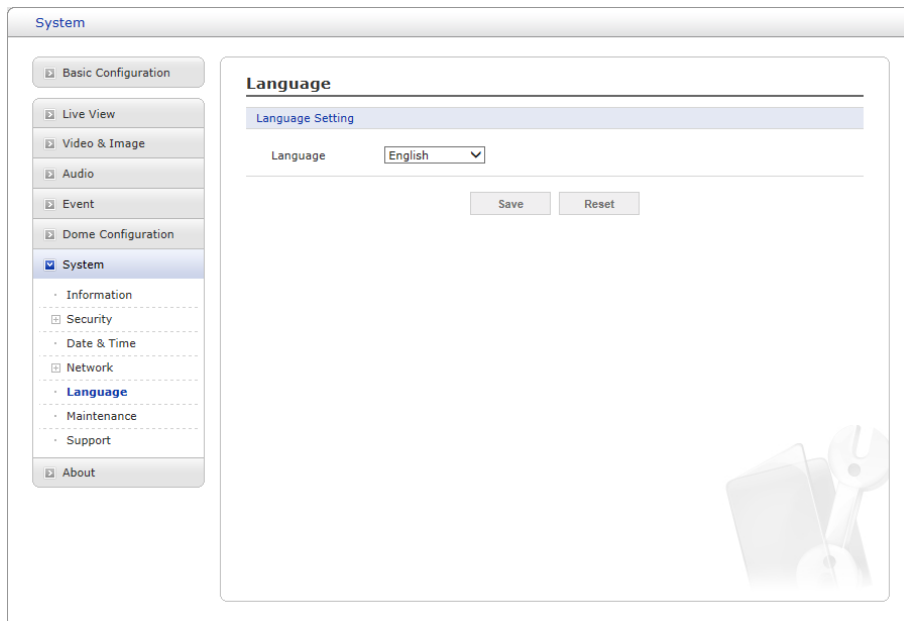

Select a user language. The language choices are English, Korean, French, Russian and Chinese. When the settings are complete, click **Save** button to save the settings, or click **Reset** button to clear all of the information you entered without saving it.

6) Maintenance

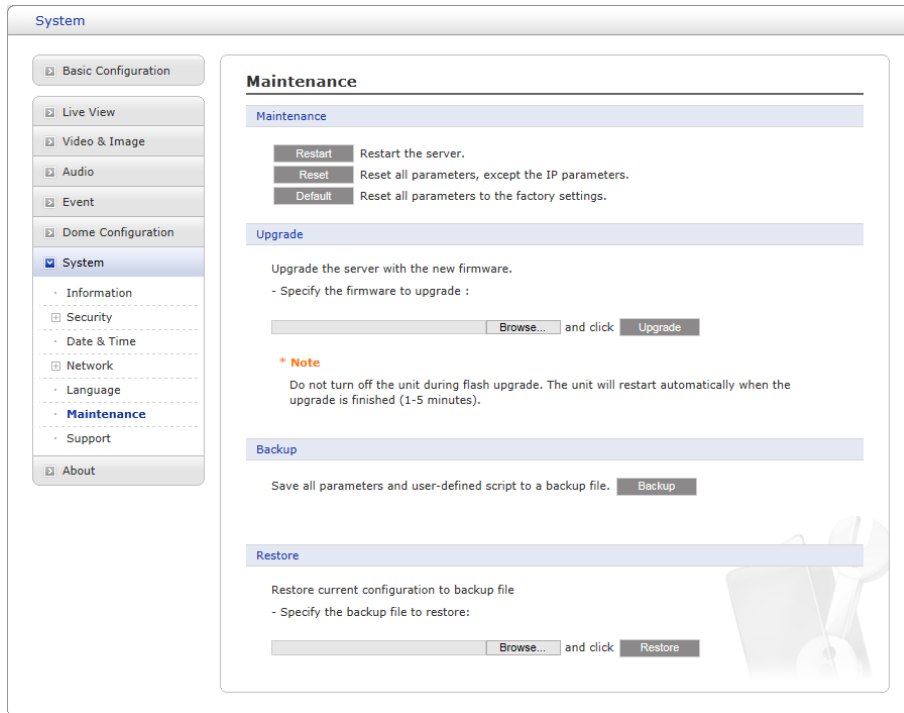

- **Maintenance:**

- **Restart:** The unit is restarted without changing any of the settings. Use this method if the unit is not behaving as expected.
- **Reset:** The unit is restarted and most current settings are reset to factory default values. The settings that are not affected are:
 - * **the boot protocol (DHCP or static)**
 - * **the static IP address**
 - * **the default router**
 - * **the subnet mask**
 - * **the system time**
- **Default:** The **Default** button should be used with caution. Pressing this will return all of the network camera's settings to the factory default values (including the IP address).

- **Update:** Upgrade your camera by importing an upgrade file and pressing the **Upgrade** button. During the upgrade, do not turn off the power of the network camera. Wait at least five minutes and then try to access the camera again.
- **Backup:** Save the setting values that users have entered to the network camera to a user PC.
- **Restore:** Import and apply a setting value previously saved to a user PC.

NOTE: Backup and Restore can only be used on the same unit running the same firmware. This feature is not intended for multi-configurations or for firmware upgrades.

7) Support

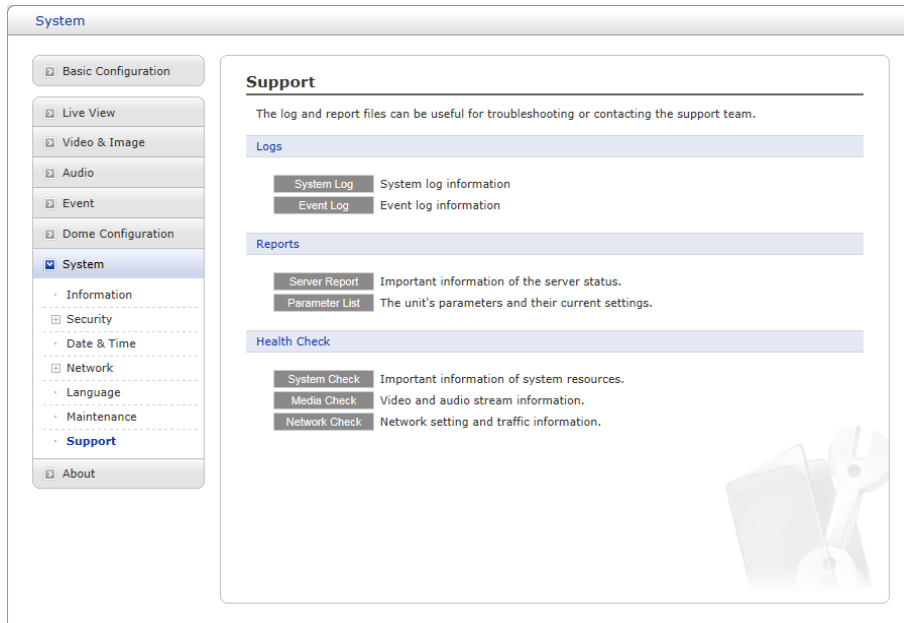

The support page provides valuable information on troubleshooting and contact information, should you require technical assistance.

- **Logs:** The network camera supports system and event log information. Click the **System Log** button to get the system log data or the **Event Log** button to get information on events.
- **Reports:**
 - **Server Report:** Click the **Server Report** button to get the important information about the server status; this should always be included when requesting support.
 - **Parameter List:** Click the **Parameter List** button to see the unit's parameters and their current settings.
- **Health Check:**
 - **System Check:** Click the **System Check** button to get the important information about the cameras system resources. You can see the pop-up window below.

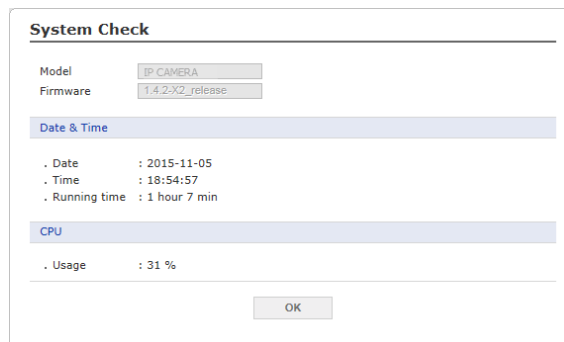

- **Media Check:** Click the **Media Check** button to get the information about the cameras video and audio stream. You can see the pop-up window below.

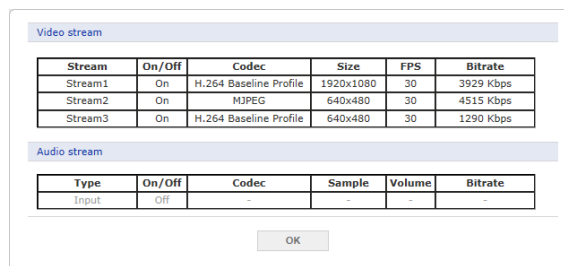

– **Network Check:** Click the **Network Check** button to get the information about the cameras network setting and traffic. You can see the pop-up window below.

Network Check

Wired configuration

- . Current Status : Connected
- . DHCP : Off
- . IP address : 192.168.30.220
- . Subnet mask : 255.255.255.0
- . Gateway : 192.168.30.1
- . DNS : 168.126.63.1

Wireless configuration

- . Current Status : Disconnected

Traffic

- . Wired : 0 Kbps

Streaming service

- . Number of users currently live : 0
- . Number of users currently playback : 0

Server connection

- . Live Push : Disconnected
- . Event Push : Disconnected

OK

3.7 Help

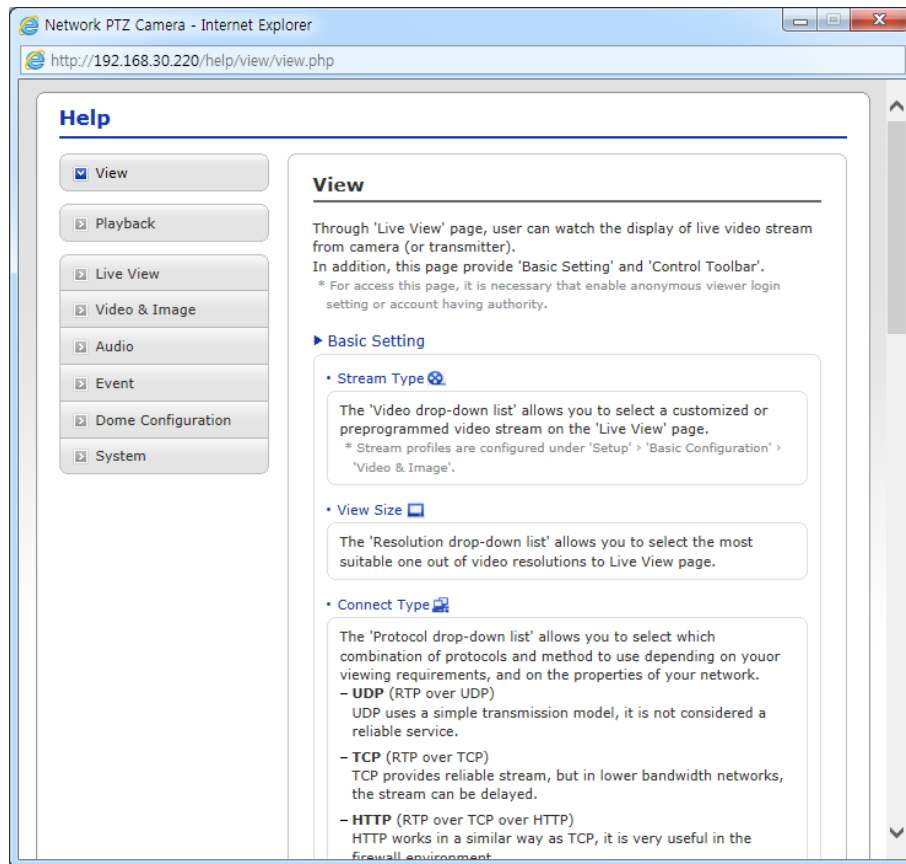

The Help information window will be provided as a popup window so that users can open and read it without needing to log-in. It will offer a description of the setting and Help page so that users can manipulate the network camera without a reference to the manual.

3.8 Resetting to the factory default settings

To reset the network camera to the original factory settings, go to the Setup > System > Maintenance web page (described in “System > Maintenance” of User’s Manual) or use the **Reset Button** on the network camera, as described below:

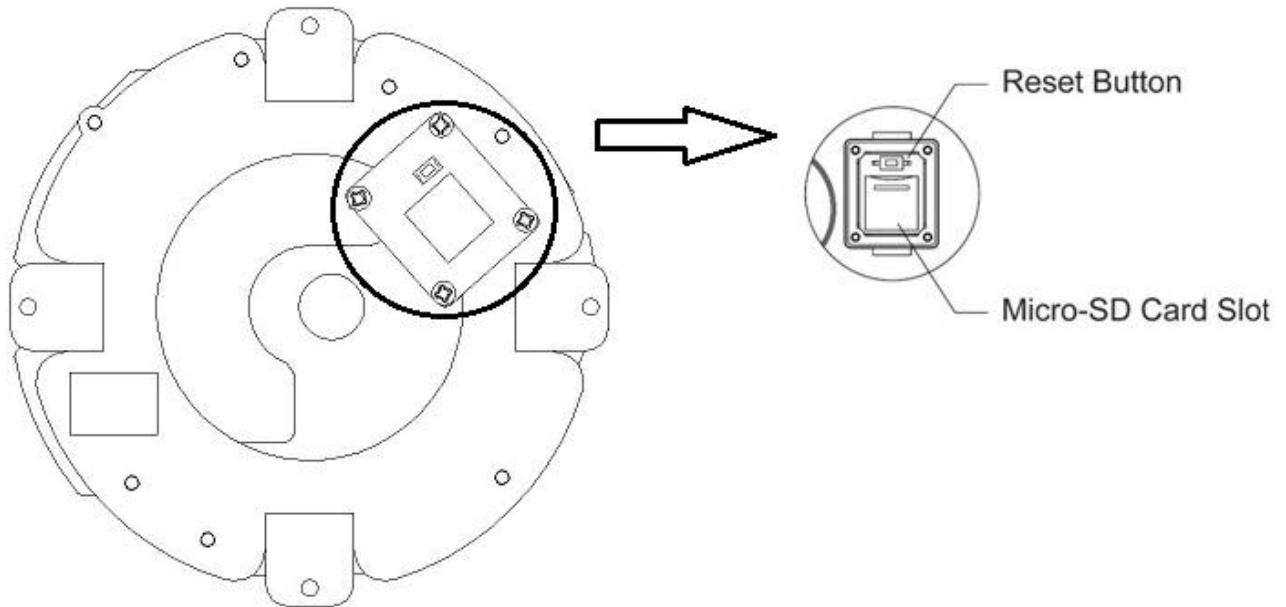

• Using the Reset button:

Follow the instructions below to reset the network camera to the factory default settings using the Reset button.

1. Switch off the network camera by disconnecting the power adapter.
2. Open the Micro-SD card cover.
3. Press and hold the Reset button (SW1) on the board with your finger while reconnecting the power.
4. Keep the Reset button (SW1) pressed for about 2 seconds.
5. Release the Reset button (SW1).
6. The network camera resets to factory defaults and restarts after completing the factory reset.
7. Tightly close the Micro-SD card cover to ensure waterproofness.

CAUTION: When performing a Factory Reset, you will lose any settings that have been saved.
(Default IP 192.168.0.129)

A Appendix

A.1 Troubleshooting

Troubleshooting if problems occur, verify the installation of the network camera with the instructions in this manual and with other operating equipment. Isolate the problem to the specific piece of equipment in the system and refer to the equipment manual for further information.

Problems/Symptoms	Possible Causes or Corrective Actions
The camera cannot be accessed by some clients.	If using a proxy server, try disabling the proxy setting in your browser. Check all cabling and connectors.
The camera works locally, but not externally.	Check if there are firewall settings that need to be adjusted. Check if there are router settings that need to be configured.
Poor or intermittent network connection.	If using a network switch, check that the port on that device uses the same setting for the network connection type (speed/duplex).
The camera cannot be accessed via a host name.	Check that the host name and DNS server settings are correct.
Not possible to log in.	When HTTPS is enabled, ensure that the correct protocol (HTTP or HTTPS) is used. When attempting to log in, you may need to manually type in http or https in the browser's address bar.
No image using Refresh and/or slow updating of images.	If images are very complex, try limiting the number of clients accessing the camera.
Images only shown in black & white.	Check the Video & Image setting.
Blurred images.	Refocus the camera.
Poor image quality.	Increased lighting can often improve image quality. Check that there is sufficient lighting at the monitored location. Check all image and lighting settings.
Rolling dark bands or flickering in image.	Try adjusting the Exposure Control setting under Camera Setup part.
H.264 not displayed in the client.	Check that the correct network interface is selected in the Video & Image/Stream.
Multicast H.264 not displayed in the client.	Check with your network administrator that the multicast addresses used by the camera are valid for your network. Check that the Enable multicast checkbox are enabled in the System/Network/RTP tab. Checks with your network administrator to see if there is a firewall preventing viewing.
Multicast H.264 only accessible by local clients.	Check if your router supports multicasting, or if the router settings between the client and the server need to be configured. The TTL value may need to be increased.
Color saturation is different in H.264 and Motion JPEG.	Modify the settings for your graphics adapter. Please see the adapter's documentation for more information.
Video cannot be recorded.	Check that the Micro-SD card is inserted properly. Check that the Micro-SD card is formatted properly.

A.2 Alarm Connection

The following connection diagram gives an example of how to connect a network camera.

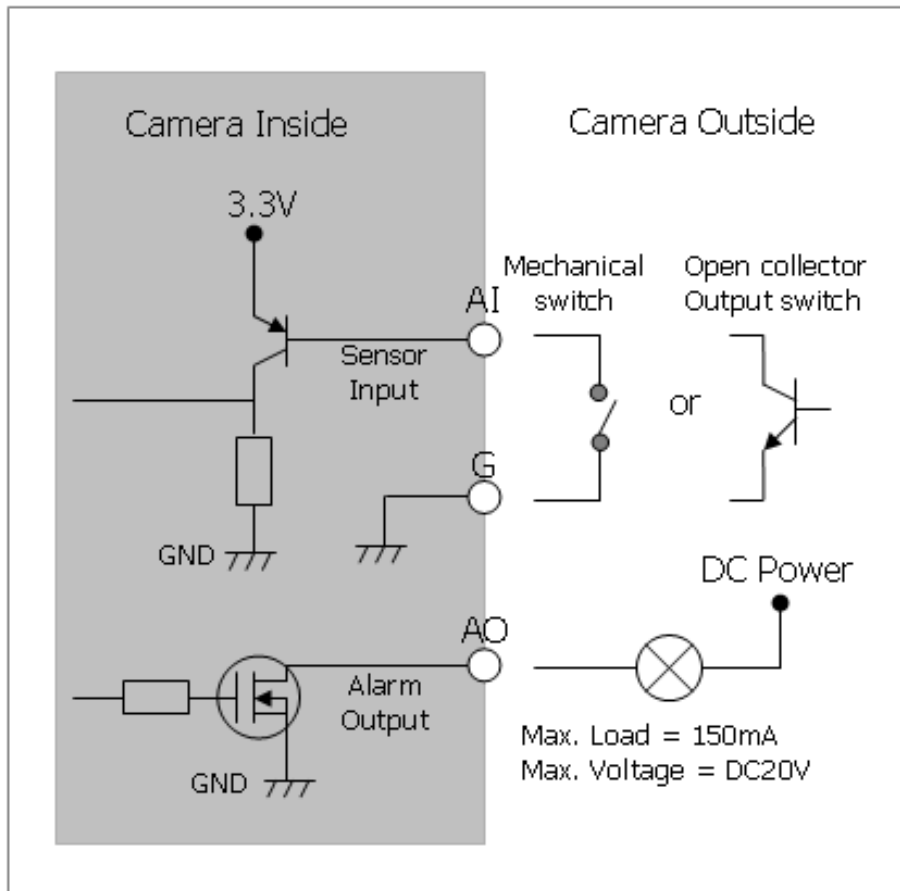

A.3 Preventive Maintenance

Preventive maintenance allows detection and correction of minor that faults before they become serious and cause equipment failure.

Every three-month, perform the following maintenance.

1. Inspect all connection cables for deterioration or other damage.
2. Clean components with a clean damp cloth.
3. Verify that all the mounting hardware is secure.

A.4 Product Specification

Model	Network Camera
IMAGE	
Lens	Optical Zoom 20X, 4.7~94mm
Angle of View	55.5~3°(H)
Image Type	1/2.8" SONY STARVIS CMOS Sensor
Sensor Pixels	1945(H)x1097(V)
Min. Illumination	Color : 0.35Lux, BW : 0.013Lux@50IRE
Scanning Mode	Progressive Scan
Wide Dynamic Range	True WDR(120dB)
Day and Night Mode	True Day & Night
Noise Reduction	3DNR
Digital Zoom	16X
Exposure Control	Auto, Manual, Shutter Priority, Iris Priority
White Balance Control	Auto, Fluorescent, Incandescent, Outdoor, Manual
Back Light Compensation	Yes
Image Effect	Flip
Shutter Speed	25/30fps : Auto(1/30,000~x8sec), Manual 50/60fps : Auto (1/50,000~x8sec), Manual
VIDEO/AUDIO	
Compression	H.264(Baseline, Main, High Profile), MJPEG
Bitrate Control	CVBR, VBR
Resolution	1920x1080, 1280x1024, 1280x720/960, 704x480/576, 640x360/480, 320x240
Frame Rate	Max. 50/60fps
Streaming	50/60fps(Dual Stream : H.264x1, MJPEGx1) 25/30fps(Triple Stream : H.264x2, MJPEGx1)
Audio Compression	G.711
Audio Streaming	2 Way
PTZ FUNCTION	
Pan Range	360°Endless
Pan Speed	Max. 380°/sec.(Preset)
Tilt Range	-10~190°
Tilt Speed	Max. 380°/sec.(Preset)
NETWORK	
Protocol	TCP/IP, UDP, IPv4/v6, HTTP, HTTPS, QoS, FTP, UPnP, RTP, RTSP, RTCP, DHCP, ARP, Zeroconf, Bonjour
Client Software	Web, SmartManager
Max. User Connection	Live : 10 Users, Playback : 3 Users
API Support	Open API, OnVIF Compliance
Mobile Support	Central Point (Android, iOS)
EXTERNAL IN/OUT	
Ethernet	RJ-45(10/100Base-T)
ETC	
Operating Humidity	0~90% RH(Non-Condensing)
Operating Temperature	-20~+50℃
Power Supply	PoE(IEEE802.3af Compliance, Class0), 12VDC, 24VAC
Power Consumption	250mA(12W)@PoE 1,000mA(12W)@12VDC, 24VAC
Dimension	185(W)x158(H)x185(D)mm
Net Weight	Approx. 4.25kg
Ingress Protection	IP67

* Specifications are subject to change without notice.

UNIT : mm

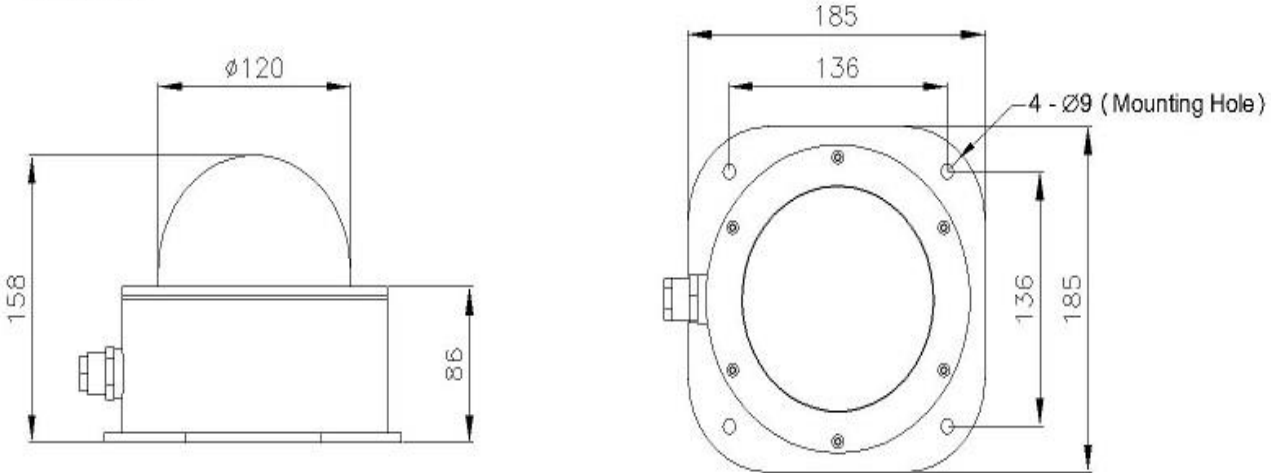

Figure – Dimension

A.5 System Requirement for Web Browser

- **Operating System:** Microsoft Windows OS Series
- **CPU:** Intel Core 2 Duo 2GHz or higher, 1GB RAM or more, 10GB free disk or higher
- **VGA:** AGP, Video RAM 32MB or higher (1024x768, 24bpp or higher)

A.6 General Performance Considerations

When setting up your system, it is important to consider how various settings and situations will affect performance. Some factors affect the amount of bandwidth (the bit rate) required, others can affect the frame rate, and some affect both. If the load on the CPU reaches its maximum, this will also affect the frame rate.

The following factors are among the most important to consider:

- High image resolutions and/or lower compression levels (or high bitrates) result in larger images. Frame rate and Bandwidth affected.
- Accessing both Motion JPEG and H.264 video streams simultaneously. Frame rate and bandwidth affected.
- Heavy network utilization due to poor infrastructure. Frame rate and Bandwidth affected.
- Heavy network utilization via wireless router due to poor infrastructure. Frame rate and bandwidth affected.
- Viewing on poorly performing client PCs lowers perceived performance. Frame rate affected.