





IR Vandal Dome IP Camera



Instruction Manual



English Version 1.1

	CAUTION RISK OF ELECTRIC SHOCK DO NOT OPEN	
CAUTION: TO REDUCE THE RISK OF ELECTRIC SHOCK DO NOT REMOVE COVER. NO USER SERVICABLE PARTS INSIDE. REFER SERVICING TO QUALIFIED SERVICE PERSONNEL.		
	The lightning flash with arrowhead symbol, within an equilateral triangle, is intended to alert the user to the presence of un-insulated "dangerous voltage" within the product's enclosure that may be of sufficient magnitude to constitute a risk of electric shock.	
	The exclamation point within an equilateral triangle is intended to alert the user to the presence of important operating and maintenance (servicing) instructions in the literature accompanying the appliance.	
WARNING: TO PREVENT FIRE OR SHOCK HAZARD, DO NOT EXPOSE THIS UNIT TO RAIN OR MOISTURE.		
CAUTION: TO PREVENT ELECTRIC SHOCK, MATCH WIDE BLADE OF THE PLUG TO THE WIDE SLOT AND FULLY INSERT.		

Important Safeguards

In addition to the careful attention devoted to quality standards in the manufacturing process of your video product, safety is a major factor in the design of every instrument. However, safety is your responsibility too. This sheet lists important information that will help to assure your enjoyment and proper use of the video product and accessory equipment. Please read them carefully before operating and using your video product.

Installation

- Read and Follow Instructions** - All the safety and operating instructions should be read before the video product is operated. Follow all operating instructions.
- Retain Instructions** - The safety and operating instructions should be retained for future reference.
- Heed Warnings** - Comply with all warnings on the video product and in the operating instructions.
- Polarization** - Do not defeat the safety purpose of the polarized or grounding-type plug.

A polarized plug has two blades with one wider than the other.

A grounding type plug has two blades and a third grounding prong. The wide blade or the third prong are provided for your safety.
If the provided plug does not fit into your outlet, consult an electrician for replacement of the obsolete outlet.
- Power Sources** - This video product should be operated only from the type of power source indicated on the marking label. If you are not sure of the type of power supply to your location, consult your video dealer or local power company. For video products intended to operate from battery power, or other sources, refer to the operating instructions.
- Overloading** - Do not overload wall outlets of extension cords as this can result in the risk of fire or electric shock. Overloaded AC outlets, extension cords, frayed power cords, damaged or cracked wire insulation, and broken plugs are dangerous. They may result in a shock or fire hazard. Periodically examine the cord, and if its appearance indicates damage or deteriorated insulation, have it replaced by your service technician.
- Power Cord Protection** - Power supply cords should be routed so that they are not likely to be walked on or pinched by items placed upon or against them, paying particular attention to cords at plugs, convenience receptacles, and the point where they exit from the video product.

- Ventilation** - Slots and openings in the case are provided for ventilation to ensure reliable operation of the video product and to protect it from overheating. These openings must not be blocked by covering. The openings should never be blocked by placing the video equipment on a bed, sofa, rug, or other similar surface. This video product should never be placed near or over a radiator or heat register. This video product should not be placed in a built-in installation such as a bookcase or rack unless proper ventilation is provided or the video product manufacturer's instructions have been followed.
- Attachments** - Do not use attachments unless recommended by the video product manufacturer as they may cause a hazard.
- Camera Extension Cables** - Check the rating of your extension cable(s) to verify compliance with your local authority regulations prior to installation.
- Water and Moisture** - Do not use this video product near water. For example, near a bath tub, wash bowl, kitchen sink or laundry tub, in a wet basement, near a swimming pool and the like.
Caution: Maintain electrical safety. Powerline operated equipment or accessories connected to this unit should bear the UL listing mark of CSA certification mark on the accessory itself and should not be modified so as to defeat the safety features. This will help avoid any potential hazard from electrical shock or fire. If in doubt, contact qualified service personnel.
- Accessories** - Do not place this video equipment on an unstable cart, stand, tripod, or table. The video equipment may fall, causing serious damage to the video product. Use this video product only with a cart, stand, tripod, bracket, or table recommended by the manufacturer or sold with the video product. Any mounting of the product should follow the manufacturer's instructions and use a mounting accessory recommended by the manufacturer.



Service

- Servicing** - Do not attempt to service this video equipment yourself as opening or removing covers may expose you to dangerous voltage or other hazards. Refer all servicing to qualified service personnel.
- Conditions Requiring Service** - Unplug this video product from the wall outlet and refer servicing to qualified service personnel under the following conditions:
 - When the power supply cord or plug is damaged.
 - If liquid has been spilled or objects have fallen into the video product.
 - If the video product has been exposed to rain or water.
 - If the video product does not operate normally by following the operating instructions. Adjust only those controls that are covered by the operating instructions. Improper adjustment of other controls may result in damage and will often require extensive work by a qualified technician to restore the video product to its normal operation.
 - If the video product has been dropped or the cabinet has been damaged.
 - When the video product exhibits a distinct change in performance. This indicates a need for service.
- Replacement Parts** - When replacement parts are required, have the service technician verify that the replacements used have the same safety characteristics as the original parts. Use of replacements specified by the video product manufacturer can prevent fire, electric shock or other hazards.
- Safety Check** - Upon completion of any service or repairs to this video product, ask the service technician to perform safety checks recommended by the manufacturer to determine that the video product is in safe operating condition.
- Wall or Ceiling Mounting** - The cameras provided should be mounted to a wall or ceiling only as instructed in this guide, using the provided mounting brackets.
- Heat** - The product should be situated away from heat sources such as radiators, heat registers, stoves, or other products (including amplifiers) that produce heat.

Use

- Cleaning** - Unplug the video product from the wall outlet before cleaning. Do not use liquid cleaners or aerosol cleaners. Use a damp cloth for cleaning.
- Product and Cart Combination** - Video and cart combination should be moved with care. Quick stops, excessive force, and uneven surfaces may cause the video product and cart combination to overturn.
- Object and Liquid Entry** - Never push objects of any kind into this video product through openings as they may touch dangerous voltage points or "short-out" parts that could result in a fire or electric shock. Never spill liquid of any kind on the video product.
- Lightning** - For added protection for this video product during a lightning storm, or when it is left unattended and unused for long periods of time, unplug it from the wall outlet and disconnect the antenna or cable system. This will prevent damage to the video product due to lightning and power line surges.

General Precautions

1. All warnings and instructions in this manual should be followed.
2. Remove the plug from the outlet before cleaning. Do not use liquid aerosol detergents. Use a water dampened cloth for cleaning.
3. Keep enough space around the unit for ventilation. Slots and openings in the storage cabinet should not be blocked.
4. During lightning storms, or when the unit is not used for a long time, disconnect the power supply, antenna, and cables to protect the unit from electrical surge.

FCC CLASS A NOTICE

NOTE

This equipment has been tested and found to comply with the limits for a Class A digital device pursuant to Part 15 of the FCC Rules. These limits are designed to provide reasonable protection against harmful interference when the equipment is operated in a commercial environment. This equipment generates, uses, and can radiate radio frequency energy and, if not installed and used in accordance with the manufacturer's instruction manual, may cause harmful interference with radio communications. Operation of this equipment in a residential area is likely to cause harmful interference, in which case you will be required to correct the interference at your own expense.

This equipment has been certified and found to comply with the limits regulated by FCC, EMC, and LVD. Therefore, it is designated to provide reasonable protection against interference and will not cause interference with other appliance usage.

However, it is imperative that the user follows the guidelines in this manual to avoid improper usage which may result in damage to the unit, electrical shock and fire hazard injury.

In order to improve the feature functions and quality of this product, the specifications are subject to change without notice from time to time.

Features



- HD CMOS Progressive Scan
- 720p or 1080p models with real-time (25/30 fps)
- 3Mega Pixel 2048x1536 or 5 Mega Pixel 2592x1920 Models
- Triple-streaming (H.264/MJPEG)
- Future proof ONVIF 2.1 compliance (1.02 backwards compatible)
- Compatible with popular third party VMS software*
- Power-over-Ethernet (PoE) operation, 14Watt max/12V operation
- Backup options: micro SD card, FTP, NAS, local
- Mobile Apps: iPhone®, iPad®, Android™
- Supports two-way audio
- 2.8-12mm Varifocal MegaPixel Lens
- 65ft (20m) IR Night Vision, True Day/Night (TDN)
- IP66 Weatherproof and IK10 Vandal Resistant
- Multi-browser support: IE, Firefox, Safari, Chrome
- 3 Axis Design for wall/ceiling mount

TABLE OF CONTENTS

1. Getting Started	1
1.1 Default Camera Username, Password, and Ports	1
1.2 Camera Interior Overview	2
1.3 ONVIF Compatibility and Included Software Overview	3
1.3.1 NVMS	3
1.3.2 CD Contents	3
2. Connection	4
3. Camera Installation	5
4. Junction Box Plate	10
4.1 Junction Box Plate Dimensions and Fitting	10
5. Junction Box Installation Types	11
5.1 Two Gang Fitting (Recommended)	11
5.2 4S Fitting	11
5.3 Octagon Fitting	11
6. Finding the Camera's IP Address	12
6.1 Finding the Camera's IP Address Using NVMS	12
6.2 Finding the Camera's IP Address using UPnP in Windows® 7	13
6.3 Finding the Camera's IP Address using Bonjour® in Mac OS®	14
6.4 Finding the Camera IP using the BNC Test Cable	15
7. Configuring Remote Connection	16
7.1 Connecting to a DDNS address using NVMS	19
8. Web Configuration	21
8.1 Supported Browsers	21
8.2 Chrome, Firefox, and Safari Setup	21
8.3 Internet Explorer® Setup	22
8.4 Web Interface/Live Video Overview	25
8.4.1 Live Video Menu	25
8.4.2 Configuring Camera Settings	26
8.5 Device Info	27
8.6 Stream Configuration	28
8.7 Device Configuration	29
8.7.1 Local Network	30

8.7.2 Device Port	31
8.7.3 Camera	32
8.7.4 Date & Time	32
8.7.5 OSD	34
8.7.6 Microphone	35
8.7.7 BNC Video Output	36
8.7.8 Language	36
8.8 Alarm Configuration	37
8.8.1 Disk Alarm	37
8.8.2 Motion Alarm	38
8.9 Local Record	40
8.9.1 Record Directory	40
8.9.2 Record Policy	45
8.10 Privacy Masking	47
8.11 Network Service	48
8.11.1 DDNS	48
8.12 Service Center	49
8.12.1 SMTP (Email Alert Setup)	49
8.13 Privilege Manager	50
8.13.1 Group	51
8.13.2 User	52
8.13.3 Unlocking User Accounts	53
8.14 Protocol	54
8.14.1 Protocol	54
8.15 Device Restart	54
8.16 Default Settings	55
8.17 Sensor Configuration	55
8.17.1 Image Adjust	56
8.17.2 Shutter Control	56
8.17.3 Gain Mode	57
8.17.4 Day/Night Mode	57
8.17.5 Auto Iris	58
8.17.6 Gamma	58
8.17.7 AE Meter Mode	59
8.17.8 WDR	59
8.17.9 WB Setting	60
8.17.10 Mirror	61
8.17.11 Noise Filter	61
9. Resetting to Factory Defaults	62
10. Dimensions	64
11. Troubleshooting	65

1. GETTING STARTED

The system comes with the following components:

- 1 x Camera
- 6 x Camera locking screws (3x inside camera; 3x spare)
- 1 x Surface mounting template
- 1 x Junction box plate and screw kit
- 1 x Mounting screw kit
- 1 x Allen key
- 1 x Conduit key
- 1 x RJ45 coupler
- 1 x BNC test cable
- 1 x Instruction Manual
- 1 x Quick Start Guide
- 1 x Software/Documentation CD

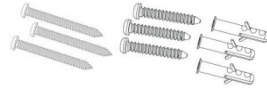

Mounting Screw Kit:

- 3 x 2.8in / 70mm screws
- 3 x 1.2in / 30mm screws
- 3 x 1.6in / 40mm anchors

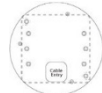

Junction Box Plate



Conduit Key



Allen Key



RJ45 Coupler



BNC Test Cable

1.1 Default Camera Username, Password, and Ports

Username: **admin**

Password: **admin**

Ports: **80** (HTTP), **30001** (Control/Streaming), **8080** (RTMP), **554** (RTSP)

IP Address: **DHCP Enabled by Default** (Router will automatically assign IP address)

NOTE: Once you have completed the basic setup of the camera, it is recommended to configure a static IP address. This will prevent the camera IP address changing in the event of a power failure. For details, see "8.7.1 Local Network" on page 30.

1.2 Camera Interior Overview

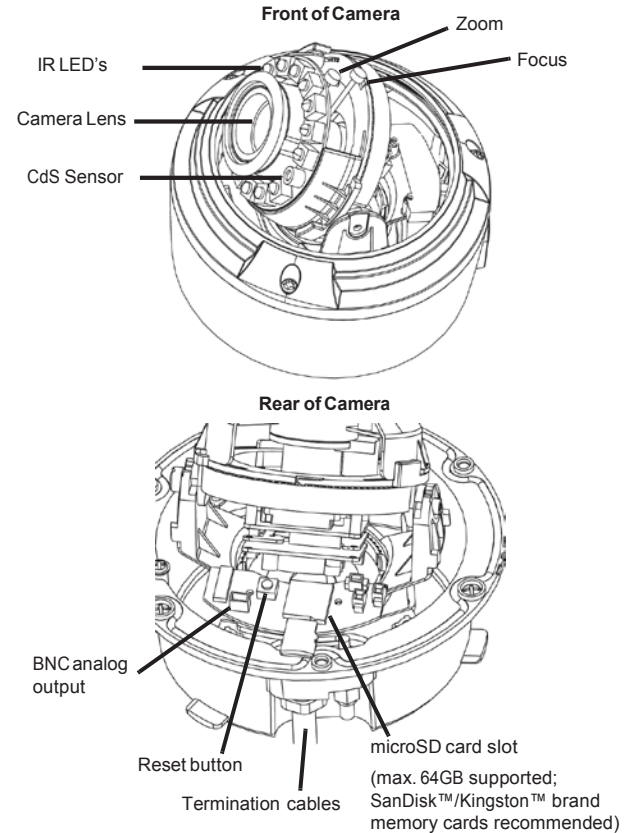

1.3 ONVIF Compatibility and Included Software Overview

This camera is ONVIF v2.1 compliant. It is designed for interoperability with popular VMS's and NVR's*, with backwards compatibility to ONVIF v.1.02. For more information on ONVIF, visit www.onvif.org

NOTE: Provided software is PC compatible only; Mac OS® access to the cameras is available via Safari® browser only.

1.3.1 NVMS

- **NVMS is a client-only solution that supports up to 36 IP cameras.** NVMS is a free software provided on the CD.
- NVMS supports all the features of the camera. It can access microSD/ SD card recordings and camera setup over a local network.
- NVMS manual is provided on the CD.

1.3.2 CD Tools

• CD contents Folders

IP Search	; Search find IP Cameras and set IP address and gateway
NTP Service Tool	; Time Sync Application: IP devices match one PC system time.
FTPUpdater	; Firmware Update tool
IP Support Help Files	; Website support help documents for common problems.
RTSP Tool	; provides RTSP string command f. e.g VLC or Quick-time use
SD Driver	; Ext2 driver for Windows XP to read sd Memory card on PC
Onvif_Help	; documents on Onvif specifications
Open the NTP service	; Windows XP only enables NTP time to be enabled.
Adobe Flash Player	; Flash Video player for Windows IE plugin and Apple Mac OS
Adobe AcrobatReader	; Windows and Max OS Acrobat Reader v10

Files:

IP_series_bitrate_calculator.htm	; Simple storage calculator for IP devices
NVMS_Install.exe	; NVR Software installation for PC
NVMS_Manual_1.7.pdf	; Guide to use the NVMS Software
SNMedia_Player.exe	; File Player for recorded files / backup files from devices / NVMS.

2. CONNECTION

The camera has the following termination cables:



- 1. RJ45 Network Interface:** Connect to a router or switch on your network using RJ45 Ethernet cable (Cat5e or better). 100Mhz connection. PoE supported (class 3 PoE switch required).

NOTE: Use the included RJ45 coupler to connect to male end of RJ45 Ethernet cable.



RJ45 Coupler

- 2. Audio Input (RCA):** Connect to a self-powered microphone for listen-in audio.
- 3. Audio Output (RCA):** Connect to an amplifier or self-powered speaker for intercom/2-way audio.
- 4. DC12V (1A):** 12V DC power input terminal. Make sure to follow correct polarity (+/-) marked on the power connector when connecting to power.
 - **Minimum Power Requirement:** 550mA / 6.6W.

3. CAMERA INSTALLATION



Make sure to follow the correct polarity if connecting the camera to DC power. Polarity is marked on the power connector.

All Installation Methods

1. Loosen the three tamper screws using the provided allen key. Lift the dome cover.

NOTE: If you plan to use conduit fitting, remove conduit cap using the provided conduit key.

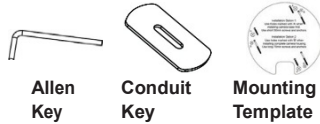

Method 1 - Direct Attach Install

2a. Use the included mounting template (Installation Option 2) to mark and pre-drill the required holes. Remove 2 of the 3 base locking screws. Use 2pc of the 2.8" screws to mount the camera directly to the mounting surface.

Remove the 3rd base locking screw and install the 3rd 2.8" screw.

Go to step 4 to complete installation.

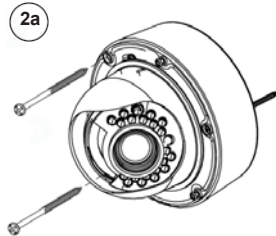
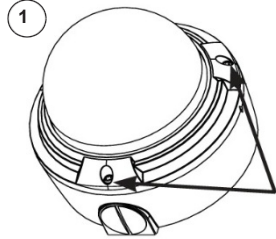

Method 2 - Camera Base Install

2b. Use the included mounting template (Installation Option 1) to mark and pre-drill the required holes.

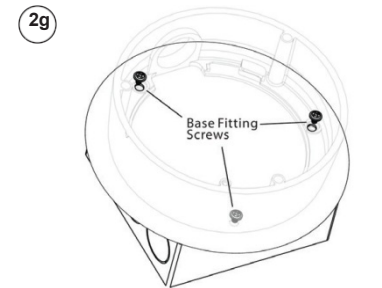
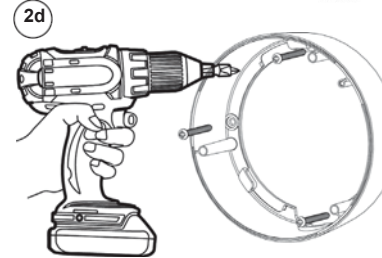
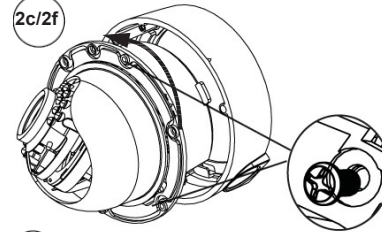

2c. Remove the camera base by unscrewing the 3 base locking screws, and turn camera module approx. 5 degrees counterclockwise to detach camera base from the camera module.

2d. Install the base to the correct holes as indicated on the mount template using the 1.2" screws.

Go to step 3a to complete installation.

Method 3 - Junction Box Install

2e. Attach provided fitting plate to junction box (see "5. Junction Box Installation Types" on page 11).

2f. Remove the camera base by unscrewing the 3 base locking screws, and turn the camera module approx. 5 degrees counterclockwise to detach camera base from camera module.

2g. Install the base to the junction box plate using the base fitting screws.

Go to step 3a to complete installation.

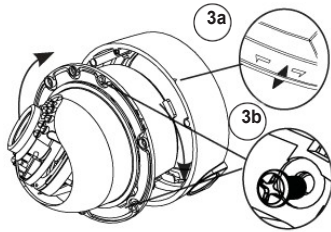

Reattaching the Camera Module
3a. Reinsert camera module into camera base by aligning the arrow notches on the edge of the camera module and the camera base (label on edge of camera module indicates the location of the arrow notch), and turning camera module clockwise to lock into place.

3b. Use the 3 base locking screws to secure camera base to camera module.

Go to step 4 to complete installation.

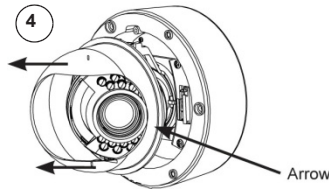

4. Remove camera cover by squeezing the back and front of the cover (as indicated by the arrow indicators) at the same time and lifting it up and away from the lens.

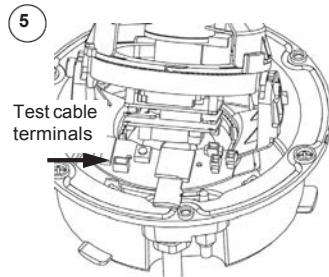

5. Insert a video test cable into the video test cable terminals and connect to a test monitor to set up camera.

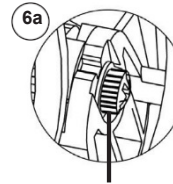

Thumb Screw

6a. Adjust camera viewing angle and secure into place by tightening thumb screw using a flat head screwdriver.



Avoid pointing the camera lens in angles where the IR LEDs are blocked by the camera cover or dome cover. If IR LEDs are blocked, it may result in an unclear nighttime image.

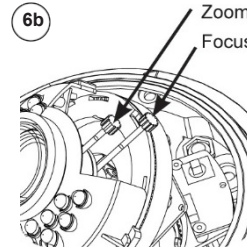

Zoom
Focus

6b. Adjust zoom and focus as required.

NOTE: Lens adjustment levers are by default in the locked position. Turn counterclockwise to unlock. Tighten levers to secure lens setting.

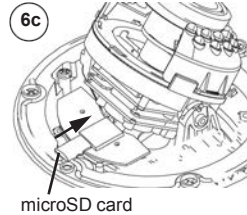

microSD card

6c. (Optional) Insert a microSD card into the camera. To enable recording, you must format the microSD card and configure microSD recording (see "8.9.1 Record Directory" on page 43).

NOTE: The camera supports microSD cards up to a maximum size of 64GB. SanDisk™ or Kingston™ brand microSD cards are recommended.

6d. Re-attach the camera cover, using the thumb screw as a guide, until it snaps into place.

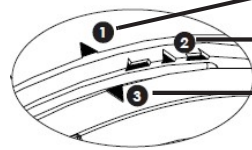
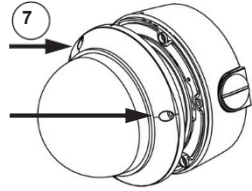

Correct Arrow Alignment

Arrow on camera base
Arrow on camera module (inside camera)
Arrow on dome cover

7. Re-attach the dome cover. **Align the arrows as shown in the diagram to ensure a waterproof seal.** Use the allen key to tighten the tamper screws. **NOTE:** Make sure dome cover cord does not get caught in the rubber seal.

4. JUNCTION BOX PLATE

Junction box plate is used to install camera into standard 4S and Octagon junction boxes. Junction box plate screw kit contains the following accessories:

- 3 x Base fitting screws (PWM3 Type)
- 4 x 2S / 4S plate screws (KM3.5 Type)
- 2 x Octagon fitting screws (KM4 Type)



Base Fitting Screw



Octagon Screw



2S / 4S Screw

4.1 Junction Box Plate Dimensions and Fitting

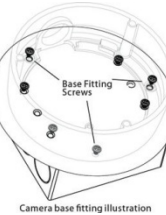
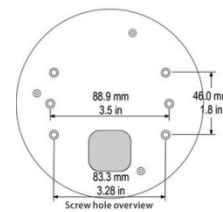

Camera base fitting illustration

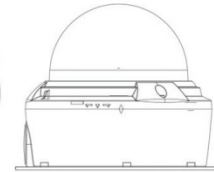

Junction box fitting plate attached to camera

5. JUNCTION BOX INSTALLATION TYPES

5.1 Two Gang Fitting (Recommended)

Two gang fitting requires 4x 2S/4S screws.

NOTE: Two gang fitting provides the most robust installation.

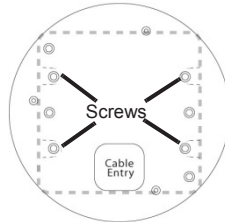

5.2 4S Fitting

4S fitting requires 2x 2S/4S screws.

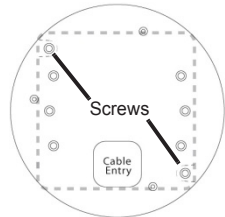

5.3 Octagon Fitting

A 4" Octagon fitting requires 2x Octagon screws.

NOTE: Screws used for the octagon fitting are larger compared to those used for the 2S/4S (M4 type).

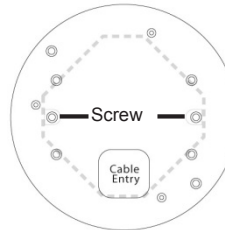

6. FINDING THE CAMERA'S IP ADDRESS

Use the steps below to find the camera's IP address and connect to the camera over the local area network (LAN) using NVMS, UPnP on Windows® 7, or Bonjour® in Mac OS®.

6.1 Finding the Camera's IP Address Using NVMS

1. Install NVMS from the CD. Now Double-click the NVMS icon () on the Desktop. The log in screen appears.
2. Under **User Name** and **Password**, enter the default NVMS user name (**admin**) and password (**admin**). Click **Login**.



Enter Admin
Enter Admin

Click Login

3. NVMS opens and scans the local network for connected cameras. Detected camera IP addresses on the LAN appear in the Device List on the left side of the screen with a  icon.

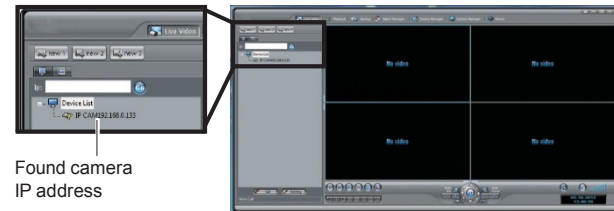

Found camera
IP address

- Click on a camera IP address in Device List to login.
- Under **User Name**, enter the user name for the camera (default: **admin**). Under **Password**, enter the password for the camera (default: **admin**). Click **Continue**.



Enter Camera User Name
(default: **admin**)

Enter Camera Password
(default: **admin**)

Click Continue to login

- The camera appears under the camera IP address. Click and drag the camera to the display grid to open it.

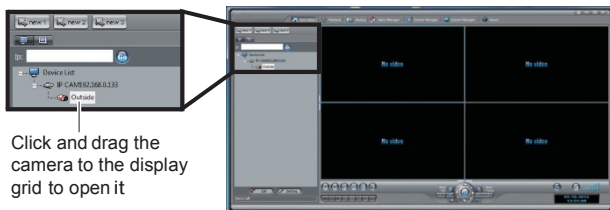

Click and drag the camera to the display grid to open it

NOTE: For detailed instructions on using NVMS, see the NVMS manual on the CD.

6.2 Finding the Camera's IP Address using UPnP in Windows® 7

NOTE: To use this method, your router must support UPnP and the camera and computer must be on the same network. UPnP is enabled in the camera by default, and can be enabled/disabled using NVMS (check the NVMS manual for details).

- Click **Start>Computer>Network**. The camera's IP address appears under Network Infrastructure.

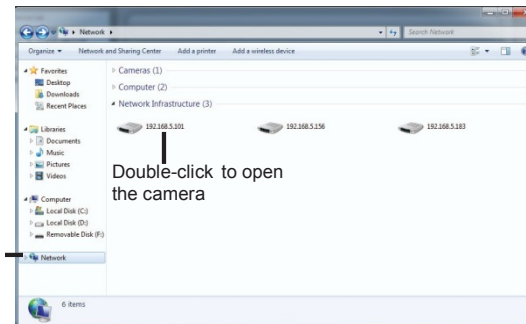

Double-click to open the camera

Network

- Double-click the camera to open it in your default browser.
- Under **User Name** and **Password**, enter the camera's User Name (default: **admin**) and Password (default: **admin**) and click **Login**.

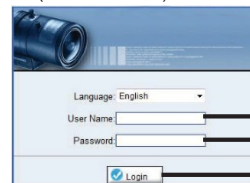

Enter Camera User Name (default: **admin**)

Enter Camera Password (default: **admin**)

Click Login

6.3 Finding the Camera's IP Address using Bonjour® in Mac OS®

NOTE: To use this method, the camera and computer must be on the same network. Bonjour® is enabled by default, and can be enabled/disabled using NVMS (check the NVMS manual for details).

- Open Safari® browser and click the Bookmarks button (🔖).

2. Click **Bonjour**. The camera's IP address appears in the Bonjour Devices list.
3. Double-click the camera to open it in Safari®.

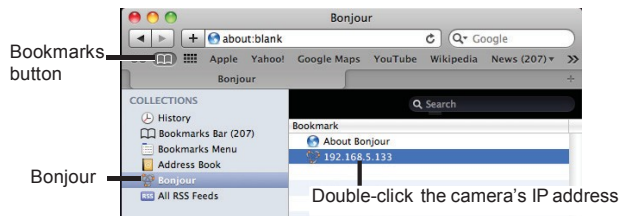

4. Under **User Name** and **Password**, enter the camera's User Name (default: **admin**) and Password (default: **admin**) and click **Login**.

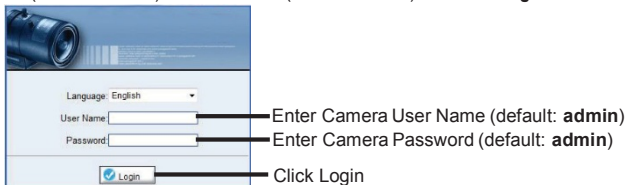

6.4 Finding the Camera IP using the BNC Test Cable

When the BNC test cable is connected to the camera, the IP address is shown on the test monitor. The camera must be connected to power to use the BNC test cable.

NOTE: The default IP address of 192.168.0.129 is shown if the camera cannot obtain an IP address from the router. Check the Ethernet/power connections and router configuration.

7. CONFIGURING REMOTE CONNECTION

Follow the steps below to configure your camera for connections over the Internet using a web browser, NVMS, or other VMS software.

Step 1 of 6: Locate the camera's local IP address:

- See "4. Finding the Camera's IP Address" on page 12.

Step 2 of 6: Port Forward your router:

You need to enable port forwarding for the following ports on your router to the camera's local IP address:

- HTTP Port (default: **80**)
- Control Port (default: **30001**)

NOTE: If you are configuring multiple IP cameras for individual remote access, you must change the ports for each camera. Two cameras cannot use the same port number.

NOTE: Port forwarding the RTSP and RTMP ports is not necessary unless your installation has special requirements.

There are two methods for port forwarding:

- You can manually port forward your router. See your router's user manual for details. An example of a port forwarding screen is shown below.

Port Range					
Application	Start	End	Protocol	IP Address	Enable
HTTP	80	to 80	Both	192.168.1.100	<input checked="" type="checkbox"/>
Control	30001	to 30001	Both	192.168.1.100	<input checked="" type="checkbox"/>

Step 3 of 6: Locate your camera's MAC address:

1. Open a web browser and enter the camera's IP address in the address bar in the following format:

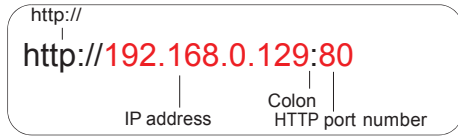

2. Under **User Name** and **Password**, enter the camera's User Name (default: **admin**) and Password (default: **admin**) and click **Login**.
3. Click **Device Info** and write down the **MAC Address**.

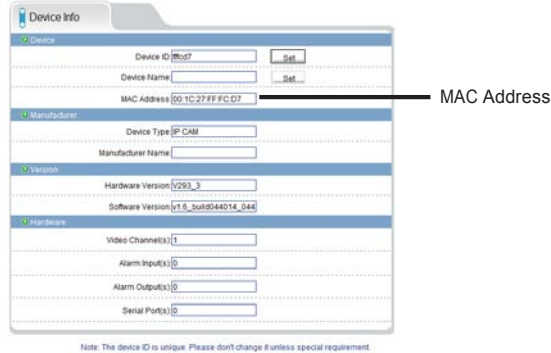

Step 4 of 6: Register for DDNS:

Register for one of the DDNS services which are currently supported for use with your IP camera. A DDNS account allows you to set up a web site address that points back to your local network. The following outlines how to set up your free DDNS account.

NOTE: Your router must support UPnP to enable DDNS.

NOTE: You may use the same DDNS account for multiple IP cameras on the same LAN.

Step 5 of 6: Enable DDNS on the camera:

1. Enter the camera's IP address in your web browser. Log in and then click **Network Service>DDNS**.
2. Check **Enable DDNS**.
3. Configure the following:
 - **Provider:** Select **the ddns service you use..**
 - **Domain Name:** Enter the **Domain Name** you received from the confirmation email you received after you created your DDNS account (e.g. mycamera.dyndns.org).
 - **User Name:** Enter the **User Name**.
 - **Password:** Enter the account name **Password**
4. Click **OK** to save settings.

Step 6 of 6: Connect to the camera's DDNS address:

1. Enter the camera's DDNS address in your web browser in the following format:



2. Under **User Name** and **Password**, enter the camera's User Name (default: **admin**) and Password (default: **admin**) and click **Login**.

Once you have logged into your system using your DDNS address, you can connect to the IP camera from a remote location using a web browser, NVMS.

7.1 Connecting to a DDNS address using NVMS

NOTE: Complete all the steps above before performing the following method.

1. Open NVMS and click **Device Manager>Video Device Manager**.
2. Click **Manager**. The Device Maintenance window opens.

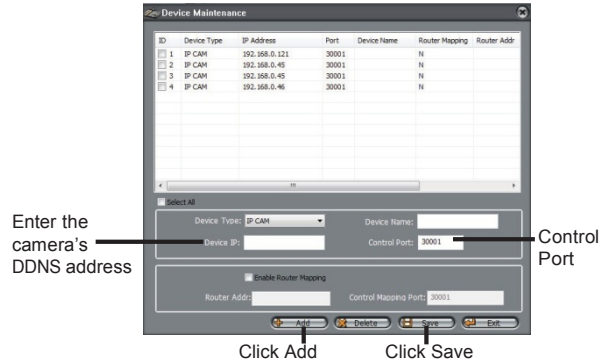

3. Under **Device IP**, enter the **Domain Name** from the confirmation email. For example, enter mycamera.dyndns.org.
4. Under **Control Port**, enter the camera's control port (default: **30001**).
5. (Optional) Under **Device Name**, enter a name for the camera.
6. Click **Add** to add the camera to the Device List.
7. Click **Save** to save changes. Click **OK**.

8. Close Device Maintenance and Device Manager, and return to the Live Video screen. The newly added camera will appear in Device List.

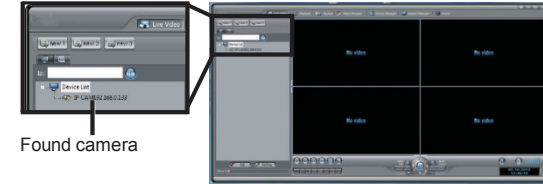

NOTE: A icon is shown for all cameras outside of the LAN. This does not affect your ability to connect to the camera remotely.

9. Click on the camera in Device List to login. Enter the **User Name** (default: **admin**) and **Password** (default: **admin**) and then click **Continue**.

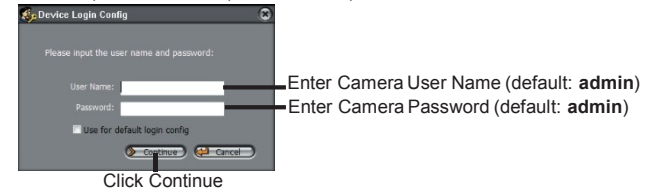

10. Click and drag the camera to a display grid screen to open it.

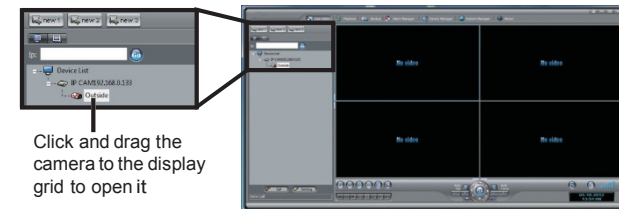

NOTE: For detailed instructions on using NVMS, see the NVMS manual on the CD.

8. WEB CONFIGURATION

The camera includes a built-in web interface that can be accessed using a web browser.

8.1 Supported Browsers

- Google Chrome, Mozilla Firefox, and Apple Safari® (via Adobe Flash Player)
- Microsoft Internet Explorer® 7.0 or later, 32-bit version (via ActiveX®)

8.2 Chrome, Firefox, and Safari Setup

1. Connect the camera to your local network and find the camera's IP address. See "6. Finding the Camera's IP Address" on page 12.
2. Open your browser and enter the camera's IP address in the address bar in the following format:



NOTE: You can also connect to the camera using a DDNS address (DDNS setup and port forwarding required; see "7. Configuring Remote Connection" on page 16 for details).

3. Under **User Name** and **Password**, enter the camera's User Name (default: **admin**) and Password (default: **admin**) and click **Login**.



Enter Camera User Name (default: **admin**)

Enter Camera Password (default: **admin**)

Click Login

4. The main screen for the camera web interface opens. From here you can view and configure the camera.

NOTE: If you do not see video from the camera, make sure your computer has the latest version of Adobe Flash Player installed (visit <http://www.adobe.com/> to download the latest version). After installing Flash Player, restart your browser and reconnect to the camera.

8.3 Internet Explorer® Setup

Step 1 of 2: Change Internet Explorer security settings for ActiveX®:

1. Open Internet Explorer and open the Security tab.
 - **Internet Explorer 8:** Click **Tools > Internet Options** and select the **Security** tab.
 - **Internet Explorer 9:** Click **IE > Internet Options** and select the **Security** tab.

2. Click **Custom Level**.

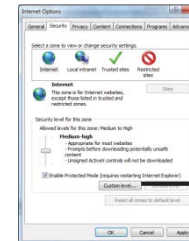

Click Custom level

- Under **Download unsigned ActiveX controls**, click **Prompt** (recommended) or **Enable**.

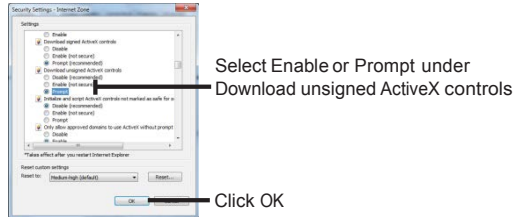

- Click **OK**. Click **OK** again to save changes.

Step 2 of 2: Log into camera:

- Connect the camera to your local network and find the camera's IP address. See "6. Finding the Camera's IP Address" on page 12.
- Enter the camera's IP address in the address bar in the following format:

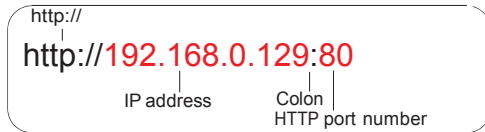

NOTE: You can also connect to the camera using a DDNS address (DDNS setup and port forwarding required; see "7. Configuring Remote Connection" on page 16 for details).

- Under **User Name** and **Password**, enter the camera's User Name (default: **admin**) and Password (default: **admin**) and click **Login**.

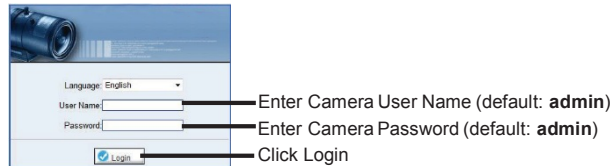

- If your computer has Flash Player installed, the main screen for the camera web interface opens. From here you can view and configure the camera.

NOTE: The ActiveX plug-in may provide smoother video performance than Flash Player. To use ActiveX, click the message above the video window. Then click inside the video area, **select Install this Add-on for all users on this computer**, and follow the prompts.

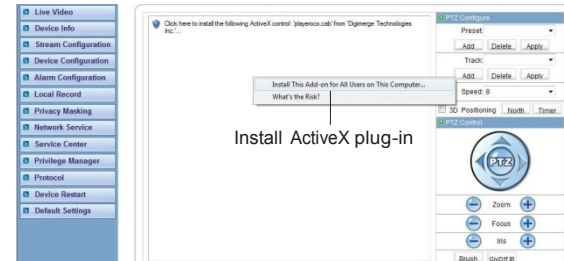

NOTE: If your computer does not have Flash Player installed, you will be prompted to select if you would like to use ActiveX or Flash Player to connect to the camera:

- Click to play live video with ActiveX control to reduce latency (recommended):** Uses an ActiveX plug-in to connect to the camera. To install the plug-in, click on the video area, and select **Install this Add-on for all users on this computer**, and follow the prompts.
- Click to download the latest version of Flash Player to play live video:** Opens a link to download Flash Player from Adobe's website. After completing the installation, restart your browser and reconnect to the camera.



Select ActiveX or Flash Player

8.4 Web Interface/Live Video Overview

Camera configuration menus

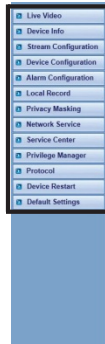

Click and drag to zoom in. Right-click and select ZoomOut to zoom out.

Double-click inside window for full-screen

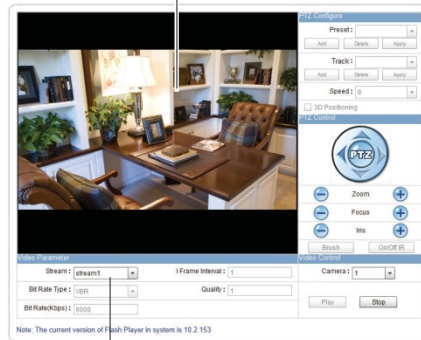

Select Stream

TIP: Select stream2 for better performance for remote connections. Stream2 has a lower resolution than stream1.

The Live video page appears when you log into the camera. Live video requires an ActiveX® plug-in or Adobe Flash Player.

8.4.1 Live Video Menu

You can right-click on the live video area to bring up the Live Video Menu.

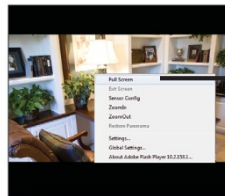

Right-click on the video area to open the Live Video Menu

The Live Video Menu contains the following options:

- **Full Screen:** Open the video in full screen. Press **ESC** to exit full screen.
- **Sensor Config:** Configure the camera sensor settings. See “8.17 Sensor Configuration” on page 55.
- **ZoomIn:** Zoom in one level.
- **ZoomOut:** Zoom out one level.
- **Restore Panorama:** Zoom out all the way.

8.4.2 Configuring Camera Settings

- Click the options on the left to configure camera settings. Setting options are detailed in the remainder of this section.

Click to select camera menus

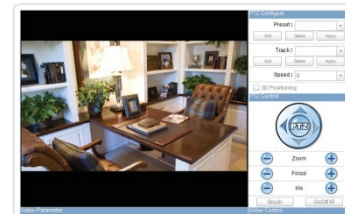
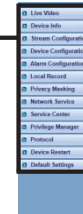

TIP: Some sub-menus have a Reset button. This button will reset the sub-menu options to factory defaults. You then have to click **OK** to save changes.

8.5 Device Info

The Device Info page shows information about your IP camera, such as the Device Name (which appears in the Device List in NVMS), firmware version, MAC address, and camera inputs and outputs. You can also configure the Device Name for your camera.

ATTENTION: The device ID is unique. Do not change it unless your installation has special requirements.

To configure the Device Name:

1. Click **Device Info**.
2. Under **Device Name**, enter the desired device name and then click **Set**.

8.6 Stream Configuration

The Stream Configuration page allows you to configure the camera's video streams. The camera supports three different video streams. This allows you to have a high quality recording stream (stream1), a lower quality stream (stream2) to preserve bandwidth for remote connections, and an MJPEG stream for applications requiring MJPEG.

To configure video streaming settings:

1. Click **Stream Configuration**. Under **Stream ID**, select the stream you would like to configure.
2. Configure the following:
 - **Video Encode Type:** Select the Video Encoding type for the stream. Stream1 and stream2 can be configured for **H.264 High Profile**, **H.264 Main Profile**, or **H.264 Base Profile**. Stream3 supports **MJPEG** only.
 - **Audio Encode Type:** Select the Audio Encoding type for the stream: **G711_ALAW**, **G711_ULAW**, or **RAW_PCM**.
 - **Resolution:** Select the resolution for the stream. Stream1 and stream3 can be set to **1920x1080** or **640x360**. Stream2 can only be set to **640x360**. Stream3 can only be set to **1920x1080**.

- **Frame Rate:** Select the frame rate for the stream up to maximum of **30FPS** for stream1 or stream2 or **12FPS** for stream3.

NOTE: Frame rate may be automatically adjusted to account for bandwidth limitations.

- **I Frame interval:** Select the interval for I frames: **1, 2, or 3**. The default value of **2** should be used unless there are special requirements. The I Frame interval does not apply to stream3.
- **Bit Rate:** For stream1 or stream2, select **CBR** (Constant Bit Rate) or **VBR** (Variable Bit Rate). Enter the desired bit rate below in kbps. Stream3 only supports VBR.
- **Quality:** Select the video quality between **1** (lowest) and **9** (highest).

TIP: A quality of 7 provides a good picture. It is not recommended to set a high quality value with a small VBR bit rate.

3. Click **OK** to apply changes.

8.7 Device Configuration

Device Configuration contains the following sub-menus:

- Local Network
- Device Port
- Camera
- Date & Time
- OSD
- Microphone
- BNC Video Output
- Language
- Multicast (Not supported)
- Dome PTZ (Not supported)

8.7.1 Local Network

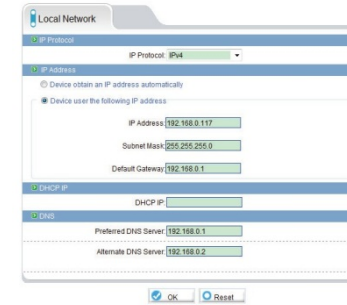

The Local Network page shows the camera's current IP address and network parameters if DHCP is enabled. It also allows you to set a static IP address for the camera (see below), set the networking parameters, and to select IPv4 or IPv6.

NOTE: DHCP is disabled by default. When DHCP is enabled, the IP address is shown under DHCP IP. Use the IPScan tool on CD to configure a static IP address. This will prevent the camera IP address changing in the event of a power failure.

To configure the camera's networking parameters:

1. Click **Device Configuration>Local Network**.
2. Under **IP Protocol**, select **IPv4** or **IPv6**. If you would like to use IPv6, make sure it is supported on your network. You may need to contact your network administrator or ISP for details.
3. Select **Device obtain an IP address automatically** to use DHCP or **Device use the following IP address** to set a static IP address for the camera. If you are using a static IP address, configure the following:
 - **IP Address:** Enter the IP address you would like to assign to the camera. Make sure the IP address is available on your network.
 - **Subnet Mask:** Enter the subnet mask.
 - **Preferred DNS Server/Alternate DNS Server:** Enter desired DNS servers.

- Click **OK** to save changes. The camera will restart with the new IP address.

8.7.2 Device Port

The screenshot shows the 'Device Port' configuration window. It contains four input fields: 'Control Port' with the value '30001', 'Http Port' with '80', 'RTSP Port' with '554', and 'RTMP Port' with '8080'. At the bottom, there are two buttons: 'OK' and 'Reset'.

The Device Port page (**Device Configuration>Device Port**) allows you to configure the camera's port configuration. The camera has the following ports:

- **Control port:** The default is 30001. Enables video streaming.
- **HTTP Port:** The default is 80. Enables web access. Please note that if the HTTP port is anything other than 80, you must enter http:// before the camera's IP address and colon (:), and the HTTP port after the IP address when connecting using an Internet browser (e.g. if the HTTP port is 85, enter http://192.168.x.x:85).
- **RTSP Port:** Default is 554. Only used for special applications requiring RTSP streaming, such as VLC player or quicktime movie.
- **RTMP Port:** Default is 8080. Only used for special applications.

NOTE: If you are configuring multiple IP cameras for individual remote access (without an NVR or server), you must change all the ports for each camera. Two cameras cannot use the same port number.

To change camera ports:

- Configure the camera ports as required and then click **OK**.
- Click **Device Configuration>Device Port**.

8.7.3 Camera

The screenshot shows the 'Camera' configuration window. It has a 'Camera' dropdown menu set to '1'. Below it is the 'Channel' section with a 'Channel Name' field containing 'DigiMerge IP' and a 'Set' button. The 'Video System' section has a 'Video System' dropdown set to '50Hz' and a 'Source Resolution' dropdown set to '1920x1080', both with 'Set' buttons.

The Camera page (**Device Configuration>Camera**) allows you to configure the Channel Name, which appears on the camera OSD and the video system frequency.

To change the Channel Name:

- Configure the **Channel Name** as needed and then click the **Set** button next to Channel Name.

To change the video system frequency:

- Select the desired setting under **Video System** and then click the **Set** button next to Source Resolution.

8.7.4 Date & Time

The screenshot shows the 'Date & Time' configuration window. It includes a 'Time Zone' dropdown set to '(GMT-05:00) Eastern Time (US Canada)'. There are two sections for daylight saving changes: 'Adjust clock for daylight saving changes' with 'Start' (Mar 2nd Sun 2:00) and 'End' (Nov 1st Sun 2:00) fields, and 'Set Manually' (2009-10-10 10:10:10). Below these are 'Device Time' (2012-10-11 9:30:56) and 'Current PC Time' (2012-10-11 9:30:56) fields with 'Apply' buttons. The 'NTP' section has 'Enable NTP' checked, 'NTP IP/DNS Name' (pool.ntp.org), and 'NTP Port' (123) fields, all with 'Apply' buttons.

The Date & Time page allows you to configure the camera's date and time.

You can set the camera's date and time the following ways:

- Using an NTP server (recommended)
- Using your computer's system time
- Manually



The camera is configured to use NTP by default, but you must set the time zone and Daylight Savings Time settings to ensure accurate time. After a power failure, the camera is configured to connect to an NTP server and automatically update the time when power is restored. If using another method to set the camera clock, time must be manually updated after a power failure.

To set the camera's date and time using an NTP server:

1. Click **Device Configuration>Date & Time**.
2. Under **Time Zone**, select your time zone.
3. If your region observes daylight savings time, check **Adjust clock for daylight saving changes**.
 - Under **Start** and **End**, select the start and end times for daylight savings.
4. Next to Current PC Time, click **Apply**.

To sync the camera's date and time to your computer's system time:

1. Click **Device Configuration>Date & Time**.
2. Un-check **Enable NTP** and click **Apply** at the bottom of the screen.
3. Under **Time Zone**, select your time zone.
4. If your region observes daylight savings time, check **Adjust clock for daylight saving changes**.
 - Under **Start** and **End**, select the start and end times for daylight savings.
5. Click **Apply** next to Current Computer Time. The Current Device Time updates.

To set the camera's date and time manually:

1. Click **Device Configuration>Date & Time**.
2. Under **Time Zone**, select your time zone.

3. Un-check **Enable NTP** and click **Apply** at the bottom of the screen.
4. If your region observes daylight savings time, check **Adjust clock for daylight saving changes**.
 - Under **Start** and **End**, select the start and end times for daylight savings.
5. Click **Set Manually**, and use the on-screen calendar to set the time and date.
6. Click **Apply**. The camera updates to the newly entered time.

8.7.5 OSD

The OSD page allows you to configure the camera's on-screen display text.

To configure the camera OSD:

1. Click **Device Configuration>OSD**.
2. Check the following options to enable OSD text:
 - **Device Name:** Display the Device Name.
 - **Channel ID:** Show the channel ID number.
 - **Channel Name:** Show the name of the channel set in the Camera menu.
 - **Time:** Show the date and time on the OSD. Select the desired date and time format under **Time Format**.

- **Custom:** Create a custom OSD message. Enter the custom OSD text under **Custom OSD**.

Device Name— IP Camera
 Channel ID— ch1
 Channel Name— dome
 Time— 15:01:47 2012-05-28 Mon
 Custom— custom OSD message

3. Enter the desired **Row** and **Column** for enabled OSD messages. Text on row 0 is shown at the top of the screen, and moves down as the row number increases. Text on column 0 is shown on the left side of the screen, and moves right as the column number increases.

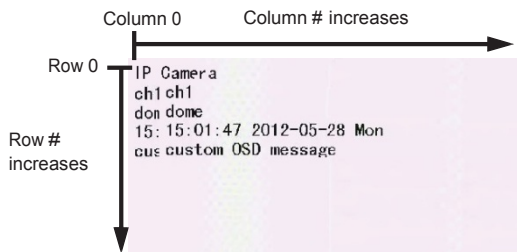

4. Click **OK** to update the camera OSD.

8.7.6 Microphone

Configure microphone settings for listen-in audio. Self-powered microphone required (not included).

To configure microphone settings:

1. Click **Device Configuration>Microphone**.
2. Check **Enable Microphone** to enable listen-in audio or un-check to disable.
3. Under **Microphone Volume**, select the volume for the microphone between **1~100**.
4. Click **OK** to save changes.

8.7.7 BNC Video Output

Under BNC Output (**Device Configuration>BNC Output**), select **On** to enable analog output or **Off** to disable and click **OK**.

8.7.8 Language

Change the language for the camera OSD display (e.g. time and date display) and email alarms. Supported languages are English, Polish, Russian, and Chinese.

To change the language for the OSD and email alarms:

1. Click **Device Configuration>Language**.
2. Under **Language**, select the desired language then click **OK** to save changes.

8.8 Alarm Configuration

Alarm Configuration contains the following sub-menus:

- Disk Alarm
- Motion Alarm
- Alarm I/O (Not supported)
- I/O Alarm Linkage (Not supported)
- Alarm Setting (Not supported)

8.8.1 Disk Alarm

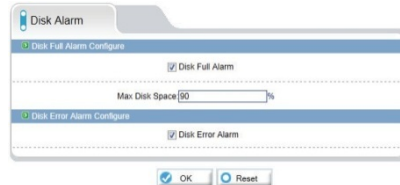

The Disk Alarm page allows you to configure alarms if there is an issue with the recording disk. You can configure a Disk Full Alarm or a Disk Error Alarm. A Disk Full Alarm triggers an alarm when the recording disk is full or exceeds a certain percentage. A Disk Error Alarm triggers an alarm if there is an error accessing or writing to the recording disk.

Alarms can be viewed using the Alarm Manager in NVMS (see the NVMS manual on the CD for details).

To configure Disk Alarms:

1. Click **Alarm Configuration>Disk Alarm**.
2. Check **Disk Full Alarm** to enable Disk Full Alarms.

3. Under **Max Disk Space**, enter the disk full percentage that will trigger an alarm (e.g. a Disk Full Alarm will be triggered when the recording disk is 80% full).
4. Check **Disk Error Alarm** to enable Disk Error Alarms.
5. Click **OK**.

8.8.2 Motion Alarm

The Motion alarm page allows you to configure camera motion detection alarm settings. You must enable motion detection to use local (e.g. microSD/SD card or FTP recording) motion detection recording. For instructions on setting up local recording, see "8.9 Local Record" on page 40. For details on motion recording using NVMS, see the NVMS manual on CD.

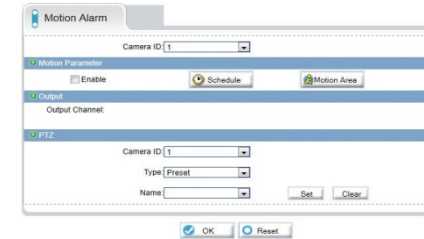
**To configure motion detection:**

1. Click **Alarm Configuration>Motion Alarm**.
2. Check **Enable** under **Motion Parameter**.

- Click **Schedule** to configure a motion detection schedule. The Schedule Time Setting menu opens.

NOTE: If the Schedule Time Setting does not open, disable any popup blockers.



- Configure the weekly schedule. The schedule is divided into 3 periods, and motion detection will be enabled in all times during all 3 periods.
- Click **Motion Area**, and configure up to 8 motion detection areas:
 - Select **Area Motion** or **Area Mask** to configure motion detection areas.
 - Area Motion allows you to select areas where motion detection is enabled.
 - Area Mask enables the entire image for motion detection, and allows you to select areas to disable motion detection.
 - Right-click to delete the last created area.
- Under **Sensitivity**, select the sensitivity for motion detection: **Low**, **Medium**, or **High**.

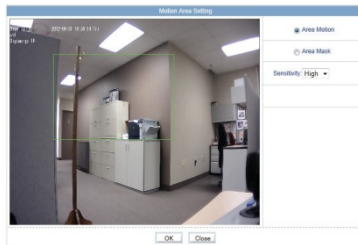

- Click **OK** to save your settings.

8.9 Local Record

Local Record contains the following sub-menus:

- Record Policy
- Record Directory

8.9.1 Record Directory



Record Directory allows you to configure the microSD/SD memory card, NAS, and FTP storage locations. It also allows you format the microSD/SD card.

IMPORTANT: You must format the microSD/SD card using the camera before you can record to it.

To format the microSD/SD card to enable recording:

NOTE: Formatting the microSD/SD card erases all data on the card.

- Click **Local Record>Record Directory**.
- Make sure to disable all recording types in Record Policy before formatting the microSD/SD card. See "8.9.2 Record Policy" on page 45.
- Under **Disk Name**, select **SD1**.

4. Click **Modify**. The Record Disk Path menu opens.

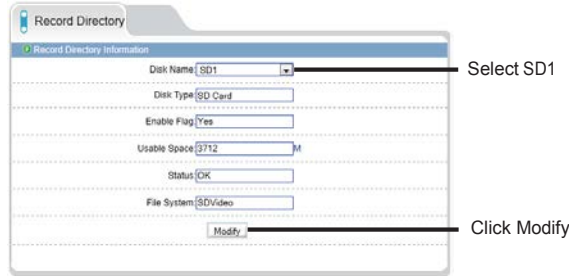

5. Check **Enable**.



6. Under **File System**, select **SDVideo** (recommended) or **Ext3**.
 7. Click **Format**. A window will appear to show the status of the formatting. Wait for the formatting to complete and then click **OK**.

NOTE: If the Record Disk Path menu does not open or formatting does not occur, disable any popup blockers.

To configure FTP storage location:

1. Click **Local Record>Record Directory**.

2. Under **Disk Name**, select **ftp**.

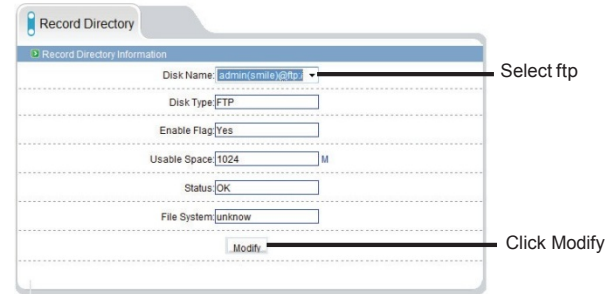

3. Click **Modify**. The Record Disk Path opens.

4. Check **Enable**.

5. Configure the following:

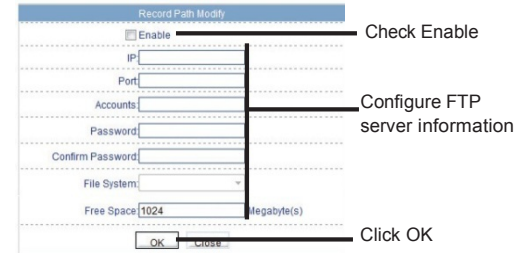

- **IP:** Enter the FTP server address.
- **Port:** Enter the FTP port number.
- **Accounts:** Enter the FTP account user name.
- **Password/Confirm Password:** Enter the FTP password.
- **Free Space:** Enter the amount of space (in MB) you would like to make available on the FTP server for recording.

6. Click **OK**.
7. Set up recording using the Record Policy sub-menu (see “8.9.1 Record Directory” on page 40). To access your recordings, use NVMS or manually access your FTP server.

NOTE: On the Record Directory page, Status will be OK when FTP is selected if FTP is accessible and all settings have been entered correctly.

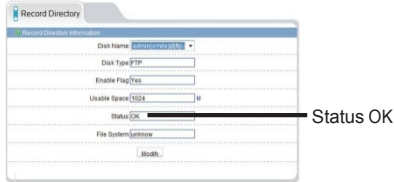

To configure a NAS storage location:

1. Click **Local Record>Record Directory**.
2. Under **Disk Name**, select **//**.

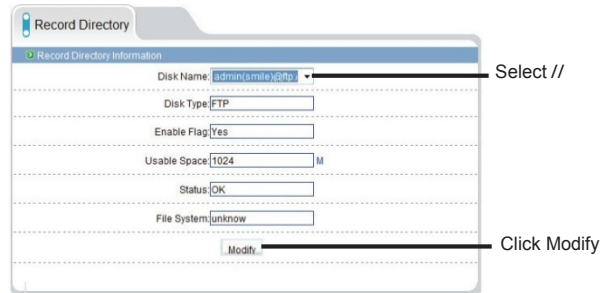

3. Click **Modify**. The Record Disk Path menu opens.

4. Configure the following:

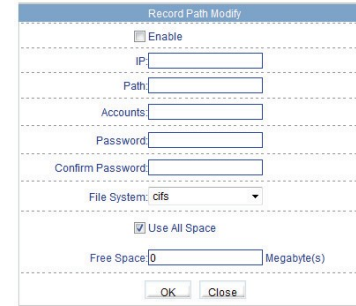

- **IP:** Enter the IP address of the NAS.
- **Path:** Enter the NAS folder where video files will be saved. NAS folder must be located directly under the root folder of the NAS (e.g. /public).
- **Accounts:** Enter the account user name for the NAS.
- **Password/Confirm Password:** Enter the account password for the NAS.
- **File System:** Enter the NAS file system (**cifs** or **nfs**).
- **Use All Space:** Check to enable the camera to record until the NAS is full. Uncheck to limit the amount of space the camera can record on and enter the amount of space (in MB) available to the camera under **Free Space**.

5. Click **OK**.

- Set up recording using the Record Policy sub-menu (see “8.9.1 Record Directory” on page 40). To access your recordings, use NVMS or manually access your NAS device.

NOTE: On the Record Directory page, Status will be OK when NAS is selected if NAS is accessible and all settings have been entered correctly.

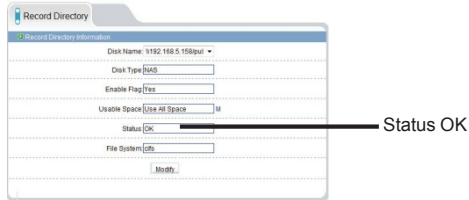

8.9.2 Record Policy

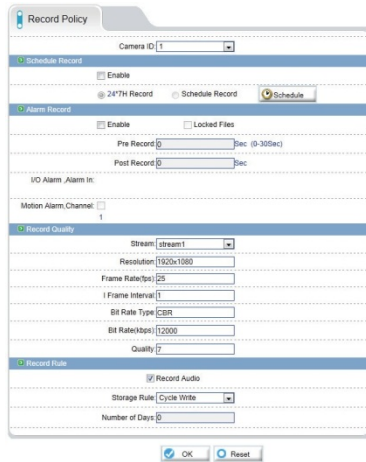

The Record Policy menu allows you to set the microSD/SD memory card, NAS, and FTP recording parameters. Once configured, the device can record video directly to a microSD/SD card, NAS, and FTP.

To enable recording to microSD/NAS/FTP:

- Click **Local Record>Record Policy**.
- Configure recording storage locations in the Record Directory sub-menu. See “8.9.1 Record Directory” on page 40.

NOTE: The camera will simultaneously record to all storage locations that have been enabled in Record Directory.

- To enable scheduled or continuous recording, check **Enable** under Schedule Record. Select **7*24 H Record** to record video continuously at all times, or, select **Schedule Record** to create a schedule for recording.
 - If you select Schedule Record, click **Schedule** and configure recording times. The schedule is divided into 3 periods, and the camera will record during all selected times in all 3 periods. Click **OK** when finished configuring the recording schedule.

Week	Schedule Time Setting					
	Period 1		Period 2		Period 3	
	Begin Time	End Time	Begin Time	End Time	Begin Time	End Time
Monday	0:00	23:30	0:00	0:00	0:00	0:00
Tuesday	0:00	24:00	0:00	0:00	0:00	0:00
Wednesday	0:00	24:00	0:00	0:00	0:00	0:00
Thursday	0:00	24:00	0:00	0:00	0:00	0:00
Friday	0:00	24:00	0:00	0:00	0:00	0:00
Saturday	0:00	24:00	0:00	0:00	0:00	0:00
Sunday	0:00	24:00	0:00	0:00	0:00	0:00

- To enable Motion Alarm Recording, check **Enable** under **Alarm Record**. Configure **Pre-recording** and **Post-recording** times. Check **Motion Alarm, Channel**.
- Under **Stream**, select the stream to use for recording. Stream1 is recommended if you want to record high quality video, stream2 is recommended if you want to save bandwidth or storage space.
- Check **Record Audio** to enable audio recording.
- Under **Storage Rule**, select **Cycle Write** to enable the camera to overwrite the oldest recorded data once the available space in the storage location is filled. Or, select **Save Days** to save video for a set

number of days and enter the **Number of Days** desired. Note that you must have sufficient storage space to save the number of days entered.

- Click **OK** to save changes.

NOTE: To view video from the SD/microSD card, FTP, or NAS, use NVMS's playback features, see the NVMS manual on the CD for details. You can access video saved to FTP or NAS by manually accessing your FTP server or NAS device.

8.10 Privacy Masking

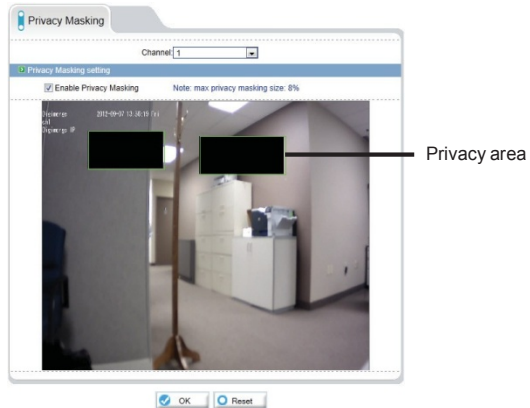

The Privacy Masking menu allows you to create up to 5 privacy areas that will not appear in recordings. You can cover up to 8% of the total image area.

To configure privacy areas:

- Click **Privacy Masking**.
- Check **Enable Privacy Masking**.
- Click and drag inside the video area to configure privacy areas. Privacy areas will be shown as green rectangles. Right-click to delete the last created area.

- Click **OK**. An error message appears if the masks configured exceed 8% of the total image area.

8.11 Network Service

Network Service contains the following sub-menus:

- DDNS
- PPPoE (Not supported)

8.11.1 DDNS



The DDNS sub-menu allows you to configure DDNS settings. Before configuring DDNS settings, you must register the camera for a free DDNS account (see "7. Configuring Remote Connection" on page 16).

To configure DDNS settings:

- Click **Network Service>DDNS**.
- Check **Enable DDNS**.
- Configure the following:

- **Provider:** Select **DunDNS** or **3322 ddns services as required**.
- **Domain Name:** Enter the **Domain Name** for your registered account with either service. This forms part of the prefix name on the domain.

NOTE: Connect to your camera using a web browser by entering **http://**, the **Domain Name**, **colon**, and then the **HTTP port**. For example, if the Domain Name is mycamera.dyndns.org, use the address <http://mycamera.dyndns.org:80>.

- **User Name:** Enter your **User Name** you registered as.

- **Password:** Enter the **Password** you have set on the account.

4. Click **OK** to save settings.

8.12 Service Center

Service Center contains the following sub-menus:

- SMTP
- Alarm Center (not supported currently)

8.12.1 SMTP (Email Alert Setup)

The SMTP sub-menu allows you to configure email alerts when motion alarms occur. Email alerts will include a .jpg snapshot attachment.

Before setting up email alerts you must configure the following:

- Motion alarms must be enabled before the camera will send email alerts. See “8.8.2 Motion Alarm” on page 38.
- A static IP address must be configured for the camera and DNS servers must be entered. See “8.7.1 Local Network” on page 30.

To enable email alerts:

1. Click **Service Center>SMTP**.

2. Check **Enable SMTP**.

3. Configure the following:

- **SMTP Server Address:** Enter the address for your SMTP server.
- **SMTP Server Port:** Enter your server’s SMTP port number.
- **User Name:** Enter the SMTP account user name.
- **Password:** Enter the SMTP account password.
- **Sender E-mail Address:** Enter the email address that will be used to send email alerts.
- **Recipient E-mail Address 1~5:** Enter up to 5 email addresses that will receive email alerts.
- **Attachment Image Quality:** Select the quality of the image attachments: **High, Mid, or Low**.
- **Transport Mode:** Select the encryption type used by the server (**SSL or STARTTLS**) or select **No encrypted** if your server does not use encryption.

4. Click **OK** to save your settings. Click **Send testmail** to send a test email alert.

8.13 Privilege Manager

Privilege Manager allows you to configure user accounts and user groups.

Privilege Manager contains the following sub-menus:

- Group
- User

8.13.1 Group

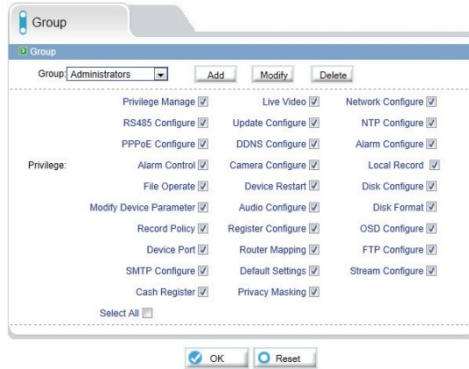

The Group page (**Privilege>Group**) allows you to manage permissions for user groups. Users obtain permissions from their group. The Administrators group contains all permissions and cannot be deleted or edited.

To add a user group:

1. Click **Add**. The Add Group menu appears.

NOTE: If the Add Group menu does not appear, disable any popup blockers.

2. Enter a name for the user group and click **OK**.

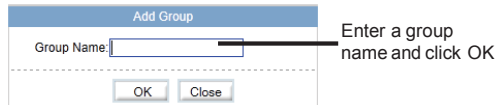

3. Under **Group**, select the new group.
4. Check the permissions you would like to apply to this user group. You can check or un-check **Select All** to select all or no permissions.
5. Click **OK** to save your new user group.

To modify a user group:

1. Under **Group**, select the group you would like to modify.
2. Click **Modify** to change the group name if needed, enter a new group name and click **OK**.
3. Change permissions as needed and click **OK**.

To delete a user group:

1. Click **Delete**. The Delete Group menu appears.

NOTE: If the Delete Group menu does not appear, disable any popup blockers.

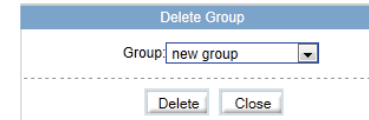

2. Select the group you would like to delete and click **Delete**.

8.13.2 User



The User page (**Privilege>User**) allows you to manage user accounts. User accounts receive privileges based on their group. The admin account is the system administrator, and has full access to all functions.

To add a user account:

1. Click **Add**. The Add User window appears.

NOTE: If the Add User menu does not appear, disable any popup blockers.

2. Enter a **User Name** and **Password** for the account and repeat the password under **Confirm**.
3. Under **Group**, select the desired user group for this account.
4. Check **Multi Login** to allow the user account to log into the IP camera from multiple location simultaneously or un-check to limit the account to a single location at a time.
5. Click **OK** to save the new user account.

To modify a user account:

1. Select the user account under **User** and click **Modify**.
2. Modify the account details as needed and click **OK**.

To delete a user account:

- Under **User**, select the user account and click **Delete**. Click **OK** to confirm.

8.13.3 Unlocking User Accounts

The admin account is the only account that can unlock user accounts that have been locked out. User accounts are locked out if the wrong password is entered 3 or more times.

To unlock a user account:

1. Login to the camera as admin.

2. Click **Privilege Manager>User**.

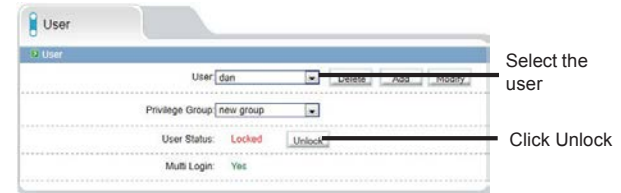

3. Under **User**, select the locked user account.
4. Click **Unlock** to unlock the account.

8.14 Protocol

Protocol contains the following sub-menus:

- Protocol
- Security (Not supported)

NOTE: Do not check User Verification in the Security sub-menu, as it may block ONVIF software from detecting the camera.

6.14.1 Protocol

The Protocol page (**Protocol>Protocol**) allows you to view ONVIF protocol settings.

8.15 Device Restart

Click **Device Restart**. Click **Restart** then click **OK** to restart the camera.

8.16 Default Settings



Click **Default Settings**. Click **Restore** then click **OK** to restore the camera to factory default settings. The camera will reboot.

8.17 Sensor Configuration

The Sensor Configuration menu is used to adjust camera image settings.

To configure camera image settings using the Sensor Configuration menu:

- Log into the camera using a web browser, and from the Live Video page, right-click on the video area and select **Sensor Config**.

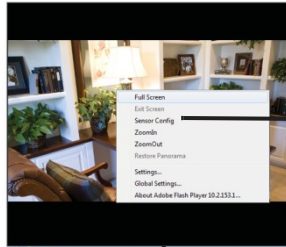

Right-click in the video area and select Sensor Config

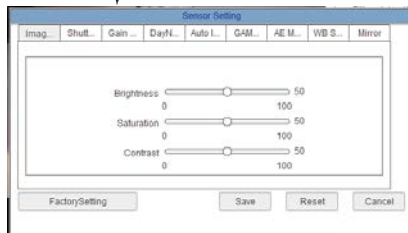

- Click **Save** to save setting changes.
- Click **Reset** to revert to the last saved changes.
- Click **Factory Setting** to revert all camera sensor settings to factory defaults.
- Click **Cancel** to exit.

TIP: Hold the mouse over the tabs to see the full name of the tab.

8.17.1 Image Adjust



Adjust the Brightness, Saturation, and Contrast settings for the image.

8.17.2 Shutter Control



Adjust the camera shutter settings.

- ShutterMode:** Select **AutoShutter** or **FixedShutter**.

- **MaxShutter:** Sets the upper limit of the shutter speed when AutoShutter is selected.
- **FixedShutter:** Sets the shutter speed when FixedShutter is selected.

8.17.3 Gain Mode



Select gain mode and adjust gain settings.

- **Gain Mode:** Select **AutoGain** or **FixedGain**.
- **MaxGain (dB):** Select the maximum gain value when AutoGain is selected.
- **FixedGain (dB):** Select the gain value when FixedGain is selected.

8.17.4 Day/Night Mode

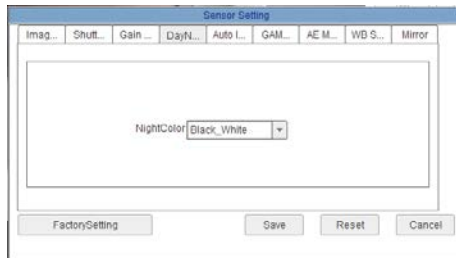

Configure color settings for night mode.

- **Night Color:** Select **Black_White** to have the camera switch to black and white during night mode or select **Multicolor** to have the camera remain in color during night mode.

8.17.5 Auto Iris

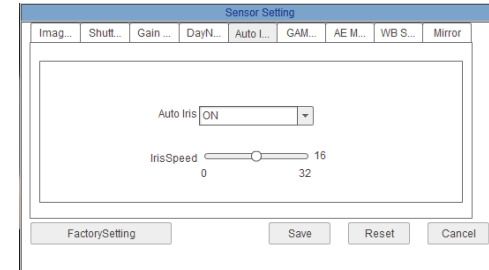

Set Auto Iris settings.

- **Auto Iris:** Select **ON** to enable or **OFF** to disable.
- **Iris Speed:** If Auto Iris is set to ON, select Auto Iris speed.

8.17.6 Gamma

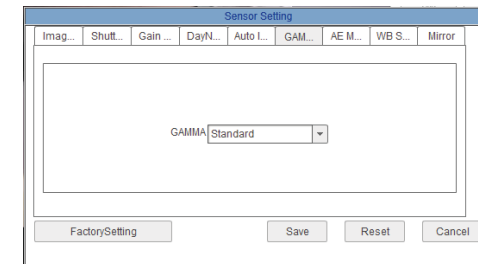

Adjust Gamma.

- **Gamma:** Select gamma setting: **Standard**, **High**, **Middle**, **Low**, or **Dynamic**.

8.17.7 AE Meter Mode

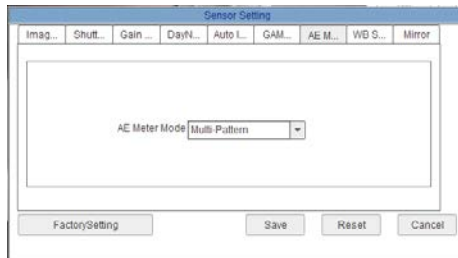

Set the Auto-Exposure Meter Mode from one of the following:

- **Multi-Pattern:** When metering light, entire image is metered symmetrically.
- **Center-Weighted:** When metering light, priority is given to the center of the image.
- **Vertical Center-Weighted:** When metering light, priority is given to the vertical center of the image.
- **Horizontal Center-Weighted:** When metering light, priority is given to the horizontal center of the image.

8.17.8 WB Setting

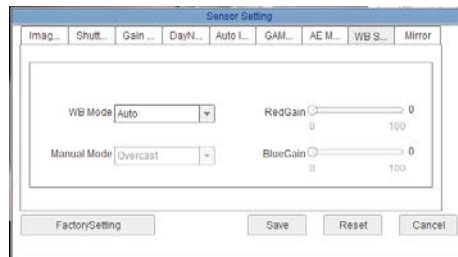

Adjust White Balance.

- **WB Mode:** Select **Auto** for automatic white balance or **Manual** to manually set the white balance.
- **Manual Mode:** Select a mode for the lighting conditions or select **Customized** and manually adjust the **RedGain** and **BlueGain**.

8.17.9 WDR (solution may not feature this setting)

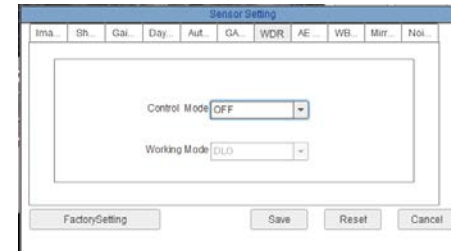

Configure settings for Digital Wide Dynamic Range.

- **Control Mode:** Select **ON** to enable Digital Wide Dynamic Range or **OFF** to disable.

NOTE: Enabling Digital Wide Dynamic Range may cause color distortion based on the lighting. If you notice color distortion, it is recommended to turn Control Mode to OFF.

- **Working Mode:** Select **DLO** (Digital Side Overflow) for environments with few moving objects. Select **MC** (Motion Compensation) for environments with multiple moving objects.

8.17.10 Mirror



Enable/disable image mirroring.

- **Mirror:** Select **Horizontal** to mirror the image horizontally, **Vertical** to mirror vertically, or **Picture Flip** to mirror both horizontally and vertically. Select **Close** to disable image mirroring.

8.17.11 Noise Filter (solution may not feature this setting)



Configure noise filter settings.

- **Noise Filter:** Select **Auto** for automatic noise filtering or **Manual**.
- **Max Level:** Select the maximum level for automatic noise filtering.
- **Level:** Select the level for manual noise filtering.

9. RESETTING TO FACTORY DEFAULTS

Follow the steps below to revert all settings to factory defaults. **The camera must be connected to power to perform a factory reset.**

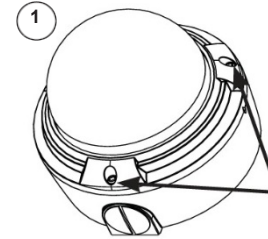

1. Loosen the three tamper screws using the provided allen key. Lift the dome cover.

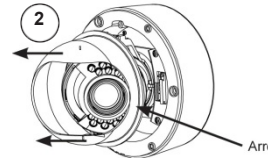

2. Remove camera cover by squeezing the back and front of the cover (as indicated by the arrow indicators) at the same time and lifting it up and away from the lens.

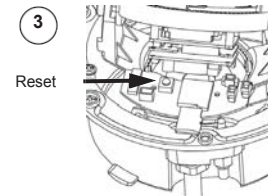

3. Press and hold the black reset button for 5 seconds then release the button to reset the camera to factory defaults.

4. Re-attach the camera cover, using the thumb screw as a guide, until it snaps into place.

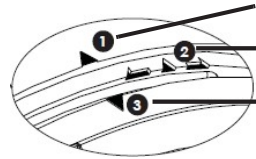
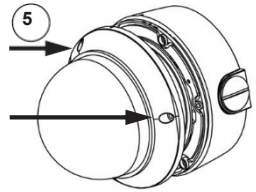

Arrow on camera base
Arrow on camera
module (inside camera)

5. Re-attach the dome cover.
Align the arrows as shown in the diagram to ensure a waterproof seal. Use the allen key to tighten the tamper screws.

NOTE: Make sure dome cover cord does not catch in rubber seal

Correct Arrow Alignment

Arrow on dome cover

10. DIMENSIONS

**Camera
Dimensions**

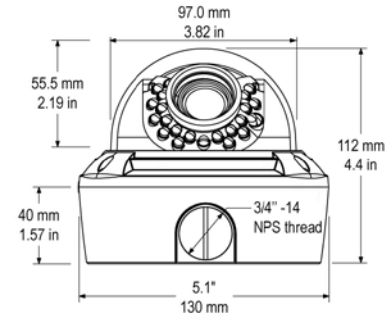

**Base Hole Screw
Dimensions**

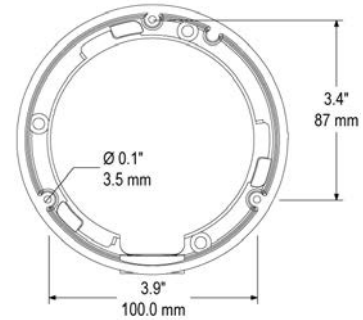

11. TROUBLESHOOTING

Can't find the camera IP address using NVMS or other software:

- Make sure Ethernet and/or DC power cables are correctly connected to the camera.
- Make sure the PoE switch or DC power source meets the camera's power requirements (class 3 PoE / 450mA / 5.4W / 12V). If using PoE, make sure the PoE switch is powered on.
- Make sure the PC is on the same network as the camera. Ping the camera's IP address. On your PC, go to **Start > Programs > Accessories > Command Prompt**. Type **ping** then the **camera's local IP address** and press **Enter**. If you get the message "Request timed out," PC and camera are not on the same network or camera is not connected. Camera is connected if you receive replies.
- Connect the BNC test cable to the camera and the other end to a test monitor. The monitor display shows the camera's IP address. A default IP address of 192.168.0.129 may mean that the camera cannot obtain an IP address from the router. Check the Ethernet/power connections and router configuration.
- Camera set for static IP mode using an incorrect IP address. By default, the camera is set for DHCP mode, which means it will automatically obtain an IP address from your router. Reset the camera to factory default settings by removing the camera cover and pressing the reset button for 5 seconds or more.

Can't connect to the camera on a web browser using local IP address:

- See steps above.
- Verify the camera's local IP address using one of the methods listed in "Finding the Camera's IP Address" on page 12.

Can't connect to camera on a web browser using a DDNS address:

- Port forwarding not set up. Make sure the HTTP port (default: **80**) and Control port (default: **30001**) are forwarded on your router to the camera's local IP address.
- Multiple cameras using same port number to connect. Configure each camera to use different ports and port forward the new ports (see "8.7.2 Device Port" on page 31 for details on changing camera ports).

Can't connect to camera video on a web browser:

- If using IE, make sure to install ActiveX plug-in or Adobe Flash Player. For more information, see "8.3 Internet Explorer® Setup" on page 22.
- If using a browser other than IE (e.g. Google Chrome, Apple Safari, Mozilla Firefox), make sure latest version of Adobe Flash Player is installed.

Video performs poorly on browser:

- Insufficient bandwidth available for high-quality stream1. Select **stream2** under **Stream**. Stream2 provides a lower-resolution to conserve bandwidth and improve performance on low-bandwidth connections.
- If using IE, click the message above the video area to use ActiveX plug-in instead of Flash Player. ActiveX may provide smoother video performance.

User account is locked:

- User accounts are locked when the password has been incorrectly entered 3 times. To unlock the account, login to the camera web interface as admin. Click **Privilege Manager>User**. Under **User**, select the locked user account and click **Unlock** to unlock the account.