

2 Mega Pixel Network Indoor Dome Camera



Description:

The CDIH109 indoor dome camera provides high quality video with (1080p) 2.0 mega pixel resolution. The ability to be powered by PoE simplifies installation. Costar Video's IP cameras are compatible with the iNEX user interface platform. The iNEX user interface incorporates features such as simplified user management, advanced camera mapping and logical camera grouping making it easier to monitor and access each of your cameras. The iNEX user interface also has the ability to integrate both analog and IP camera technology on the same platform allowing you to have a diverse surveillance system. Costar Video's IP cameras are OnVIF supported. The industry standard OnVIF protocol makes it easy to integrate Costar branded IP cameras with OnVIF compatible recorders.

Features:

- 2 mega pixel resolution (1080p)
- 3-9 mm auto iris and vari-focal lens
- 1/2.7" CMOS Progressive Scan image sensor
- True day/night with IR cut filter
- OnVIF supported; iNEX compatible
- Back Light Compensation (BLC)
- 2 Dimensional Noise Reduction (2DNR)
- SD memory card supported
- Multiple compression (H.264, MJPEG, MPEG-4)
- Motion detection
- Dual IP streaming
- Event buffering
- Password protection, IP filtering
- Power over Ethernet (PoE) or DC12V



WARNING

TO REDUCE THE RISK OF FIRE OR ELECTRIC SHOCK, DO NOT EXPOSE THIS PRODUCT TO RAIN OR MOISTURE. DO NOT INSERT ANY METALLIC OBJECT THROUGH THE VENTILATION GRILLS OR OTHER OPENINGS ON THE EQUIPMENT.

CAUTION



EXPLANATION OF GRAPHICAL SYMBOLS



The lightning flash with arrowhead symbol, within an equilateral triangle, is intended to alert the user to the presence of uninsulated "dangerous voltage" within the product's enclosure that may be of sufficient magnitude to constitute a risk of electric shock.



The exclamation point within an equilateral triangle is intended to alert the user to the presence of important operating and maintenance (servicing) instructions in the literature accompanying the appliance.

PRECAUTIONS

Safety ----- Installation -----

Should any liquid or solid object fall into the cabinet, unplug the unit and have it checked by the qualified personnel before operating it any further.

Do not install the unit in an extremely hot or humid place or in a place subject to excessive dust, mechanical vibration.

Unplug the unit from the wall outlet if it is not going to be used for several days or more. To disconnect the cord, pull it out by the plug. Never pull the cord itself.

The unit is not designed to be waterproof. Exposure to rain or water may damage the unit.

Allow adequate air circulation to prevent internal heat build-up. Do not place the unit on surfaces (rugs, blankets, etc.) or near materials (curtains, draperies) that may block the ventilation holes.

Cleaning -----

Clean the unit with a slightly damp soft cloth. Use a mild household detergent. Never use strong solvents such as thinner or benzene as they might damage the finish of the unit.

Height and vertical linearity controls located at the rear panel are for special adjustments by qualified personnel only.

Retain the original carton and packing materials for safe transport of this unit in the future.

FCC COMPLIANCE STATEMENT

INFORMATION TO THE USER: THIS EQUIPMENT HAS BEEN TESTED AND FOUND TO COMPLY WITH THE LIMITS FOR A CLASS A DIGITAL DEVICE, PURSUANT TO PART 15 OF THE FCC RULES. THESE LIMITS ARE DESIGNED TO PROVIDE REASONABLE PROTECTION AGAINST HARMFUL INTERFERENCE WHEN THE EQUIPMENT IS OPERATED IN A COMMERCIAL ENVIRONMENT. THIS EQUIPMENT GENERATES, USES, AND CAN RADIATE RADIO FREQUENCY ENERGY AND IF NOT INSTALLED AND USED IN ACCORDANCE WITH THE INSTRUCTION MANUAL, MAY CAUSE HARMFUL INTERFERENCE TO RADIO COMMUNICATIONS.

CAUTION: CHANGES OR MODIFICATIONS NOT EXPRESSLY APPROVED BY THE PARTY RESPONSIBLE FOR COMPLIANCE COULD VOID THE USER'S AUTHORITY TO OPERATE THE EQUIPMENT.

THIS CLASS A DIGITAL APPARATUS COMPLIES WITH CANADIAN ICES-003.

CET APPAREIL NUMÉRIQUE DE LA CLASSE A EST CONFORME À LA NORME NMB-003 DU CANADA.

CE COMPLIANCE STATEMENT

WARNING: This is a Class A product. In a domestic environment this product may cause radio interference in which case the user may be required to take adequate measures.

IMPORTANT SAFETY INSTRUCTIONS

1. Read these instructions.
2. Keep these instructions.
3. Heed all warnings.
4. Follow all instructions.
5. Do not use this apparatus near water.
6. Clean only with dry cloth.
7. Do not block any ventilation openings. Install in accordance with the manufacturer's instructions.
8. Do not install near any heat sources such as radiators, heat registers, stoves, or other apparatus (including amplifiers) that produce heat.
9. Do not defeat the safety purpose of the polarized or grounding-type plug. A polarized plug has two blades with one wider than the other. A grounding type plug has two blades and a third grounding prong. The wide blade or the third prong are provided for your safety. If the provided plug does not fit into your outlet, consult an electrician for replacement of the obsolete outlet.
10. Protect the power cord from being walked on or pinched particularly at plugs, convenience receptacles, and the point where they exit from the apparatus.
11. Only use attachments/accessories specified by the manufacturer.
12. Use only with the cart, stand, tripod, bracket, or table specified by the manufacturer, or sold with the apparatus. When a cart is used, use caution when moving the cart/apparatus combination to avoid injury from tip-over.
13. Unplug this apparatus during lightning storms or when unused for long periods of time.
14. Refer all servicing to qualified service personnel. Servicing is required when the apparatus has been damaged in any way, such as power-supply cord or plug is damaged, liquid has been moisture, does not operate normally, or has been dropped.
15. **CAUTION – THESE SERVICING INSTRUCTIONS ARE FOR USE BY QUALIFIED SERVICE PERSONNEL ONLY. TO REDUCE THE RISK OF ELECTRIC SHOCK DO NOT PERFORM ANY SERVICING OTHER THAN THAT CONTAINED IN THE OPERATING INSTRUCTIONS UNLESS YOU QRE QUALIFIED TO DO SO.**
16. **Use satisfy clause 2.5 of IEC60950-1/UL60950-1 or Certified/Listed Class 2 power source only.**
17. ITE is to be connected only to PoE networks without routing to the outside plant.



Contents

1. Description	6
1.1 Components	6
1.2 Key Features	7
2. Installation	8
2.1 Overview	8
2.2 Connection	14
2.3 Network Connection and IP Assignment	14
3. Operation	16
3.1 Access from a browser	16
3.2 Access from the internet	17
3.3 Setting the admin password over a secure connection	17
3.4 Live View Page	18
3.5 Network Camera Setup	20
3.5.1 Basic Configuration	21
1) Users	21
2) Network	22
3) Video & Image	23
4) Date & Time	25
3.5.2 Video & Image	26
3.5.3 Event	32
1) Event-In	32
2) Event-Out	37
3) Event Map	43
3.5.4 System	44
1) Information	44
2) Security	45
3) Date & Time	48
4) Network	49
5) Language	58
6) Maintenance	59
7) Support	60
3.5.5 About	60
3.6 Playback	61
3.7 Help	63
3.8 Resetting to the factory default settings	64
4. Appendix	65
4.1 Troubleshooting	65
4.2 Alarm Connection	66
4.3 Preventive Maintenance	66
4.3 Product Specification	67

1. Description

This manual applies to the CDIH109 network camera.

The Network Camera supports the network service for a sensor image with progressive scan, which can be monitored on a real-time screen regardless of distances and locations. By using its dedicated program, many users are able to have an access to the Network Camera at once or a single user can monitor various network cameras at the same time. It also enables users to play, store and retrieve a monitoring image by using a PC. All the settings and real-time monitoring screens are also provided through an access to the web.

The Network Camera is fully featured for security surveillance and remote monitoring needs. It is based on the DSP compression chip, and makes it available on the network as real-time, full frame rate Motion JPEG and H.264 (or MPEG-4) video streams.

The alarm input and alarm output can be used to connect various third party devices, such as, door sensors and alarm bells.

1.1 Components

The system comes with the following components:



Note: Check your package to make sure that you received the complete system, including all components shown above.

1.2 Key Features

- **Brilliant video quality**
The Network Camera offers the highly efficient H.264 video compression, which drastically reduces bandwidth and storage requirements without compromising image quality. Motion JPEG is also supported for increased flexibility.
- **Dual or triple streams**
The Network Camera can deliver dual or triple video streams simultaneously at full frame rate in all resolutions up to Full-HD (1920x1080) using Motion JPEG and H.264 (or MPEG-4). This means that several video streams can be configured with different compression formats, resolutions and frame rates for different needs.
- **Image setting adjustment**
The Network Camera also enables users to adjust image settings such as contrast, brightness and saturation to improve images before encoding takes place.
- **Intelligent video capabilities**
The Network Camera includes intelligent capabilities such as enhanced video motion detection. The encoder's external inputs and outputs can be connected to devices such as sensors and relays, enabling the system to react to alarms and activate lights or open/close doors.
- **Resolution**
The Network Camera supports three kinds of resolutions according to the model name.

CDIH109, 2 Megapixel, 30fps@1920x1080
- **Micro-SD Recording support**
The Network Camera also supports a micro-SD memory slot for local recording with removable storage.
- **Improved Security**
The Network Camera logs all user access, and lists currently connected users. Also, its full frame rate video can be provided over HTTPS.
- **Power over Ethernet**
Support for Power over Ethernet (IEEE802.3af) enables the unit, as well as the camera module that is connected to it, to receive power through the same cable as for data transmission. This makes for easy installation since no power outlet is needed.
- **ONVIF**
This is a global interface standard that makes it easier for end users, integrators, consultants, and manufacturers to take advantage of the possibilities offered by network video technology. ONVIF enables interoperability between different vendor products, increased flexibility, reduced cost, and future-proof systems.

2. Installation

For the operation of the Network Camera, it is necessary to connect a network cable for data transmission, power connection from supplied power adapter. Depending on operation methods, it is possible to connect an alarm cable additionally. For its fixation on different locations, please consult with an installer.

2.1 Over View

- **Front View**

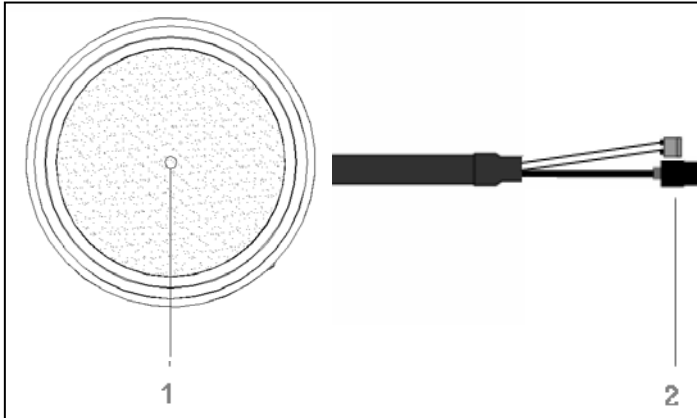

NO	Name	Description
1	Lens	Allows wide area to be monitored
2	Extension Cable	26pin camera extension cable

- **Side View**

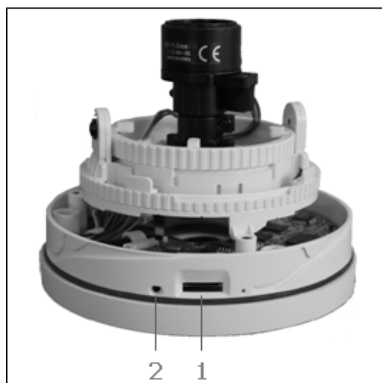

- **Bottom View**

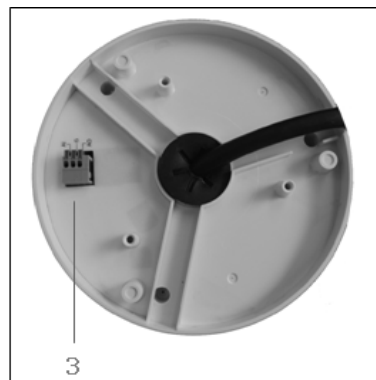

NO	Name	Description
1	Micro SD Slot	Micro SD slot for local recording
2	Status LED	Amber : On System Booting Green : Normal Operation
3	Alarm IO Terminal	AI: Alarm Input, G: Ground, AO: Alarm Output

- **Extension Cable**

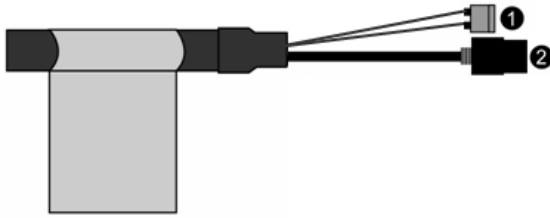

NO	Wire Color	Description
1	Red: DC12V White: GND	Main Power, 2pin terminal, DC12V 330mA(4.0W)
2	Black	Ethernet, RJ-45 port compatible with 10/100Mbps PoE. Modular Jack

- **Installing & Adjusting Camera Module**

To mount the board camera on the camera mount bracket, place the four board camera supports on the four slot holes near the front and the rear of the camera mount bracket.

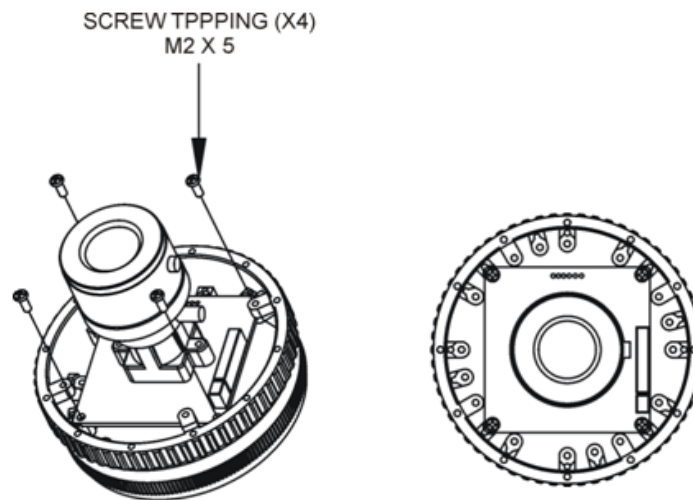

Note : Arrow mark indicates the top of the camera image.

Use the following drawings to install the camera module to the housing.

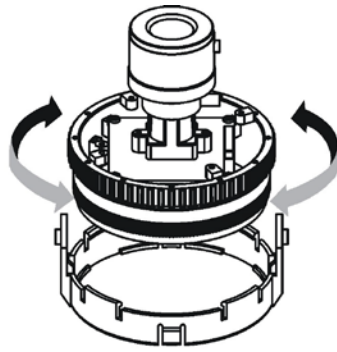

3-Axis Camera Construction
Camera lens can be moved horizontally or vertically and freely swiveled any angle.

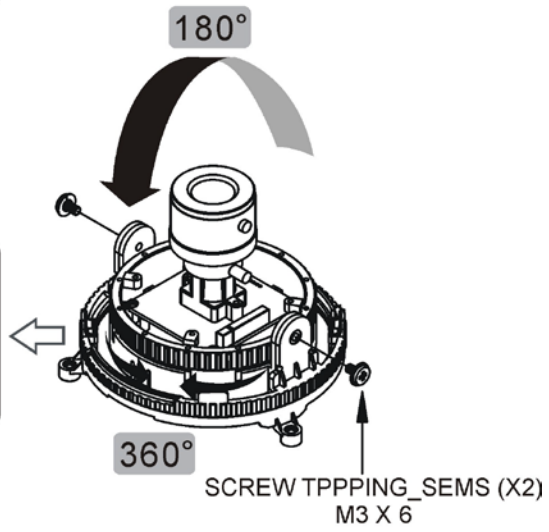

SCREW TPPPING (X3)
M2 X 10

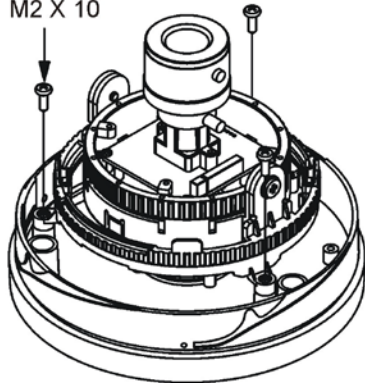

- **Base Installation**

Make mounting holes and cable hole in the place (ceiling) to which this dome. Camera is installed using the Template sheet.

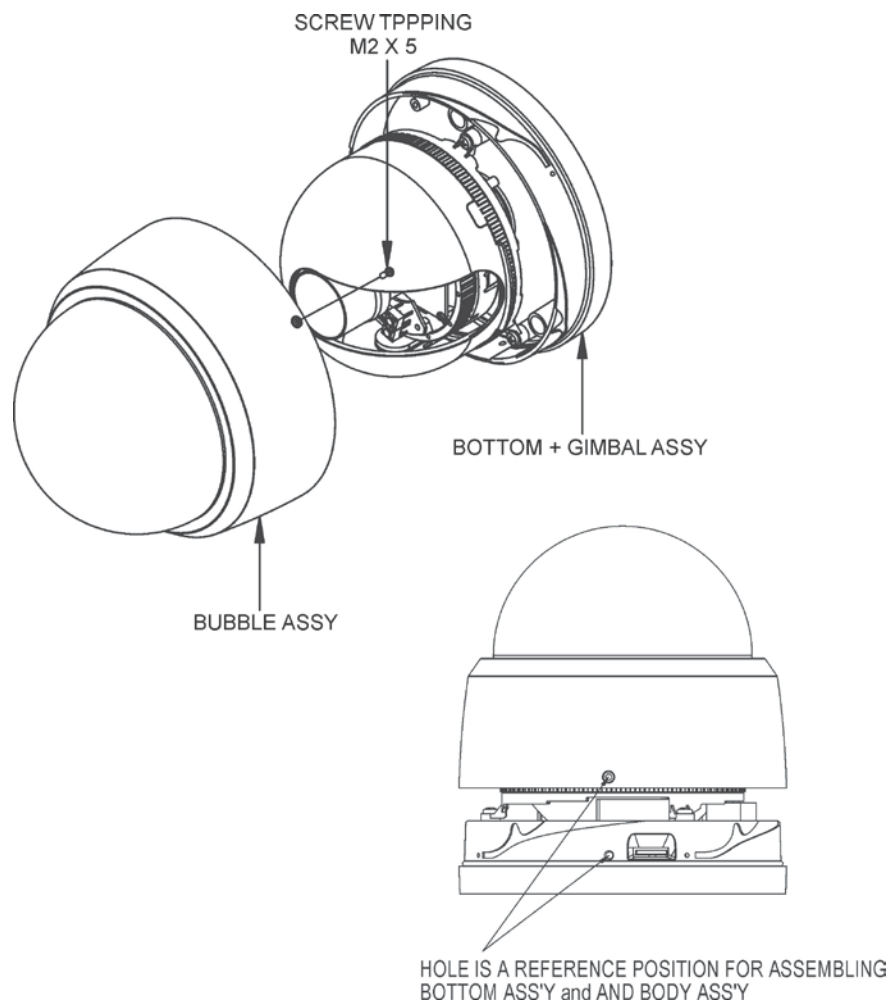

To remove dome cover, turn the dome cover counterclockwise until locators reach end of travel and pull off. Push the liner in the direction of the arrow (three 'OPEN' marks) and pull it out.

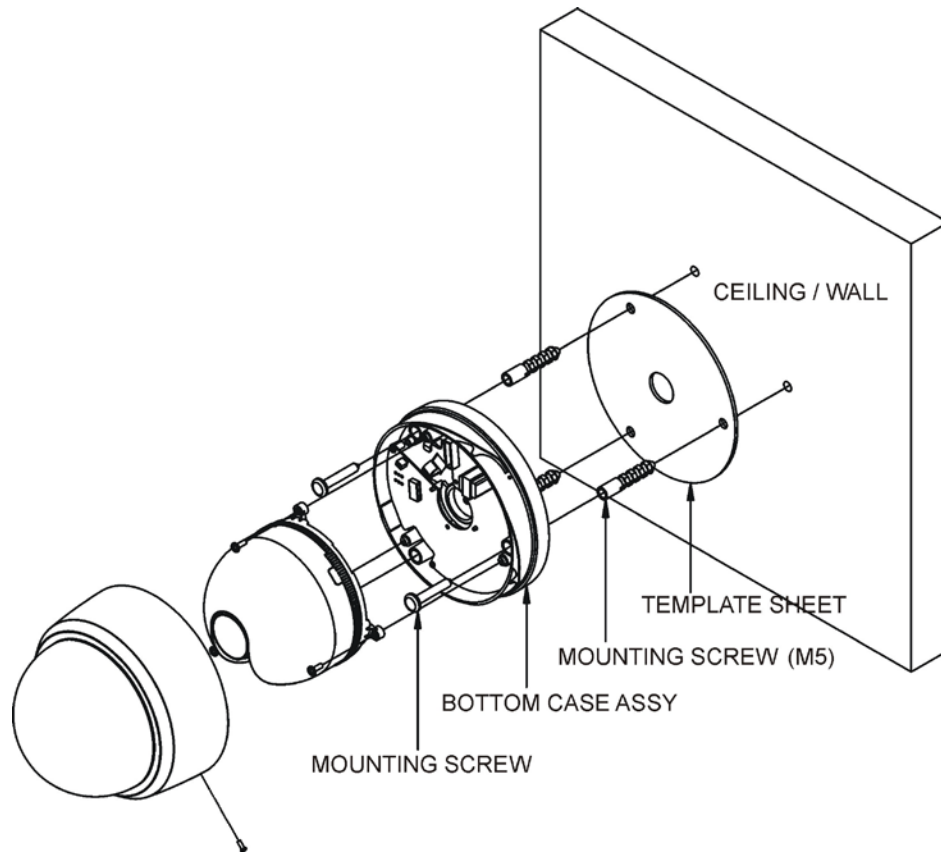

Fasten Mounting screws(2X) and align the dome camera with it like above picture. Turn the dome camera to left direction about 16 degree.

The assembly of the dome window cover and liner is in reverse order of disassembly Finally, lock dome window cover with locking screw(M2X4) from the accessory kit.

- **Using the Quick install Adaptor (option)**

Use the optional Quick install Adaptor on wall or ceiling application

1. Install the Adaptor into the mounting surface and use the screws to adjust the position of the two locking arms on the Quick Install Adaptor
2. Push the cables through the opening and 1/2" hole grommet
3. Make sure the grommet is property installed on the adaptor to prevent dust ingress

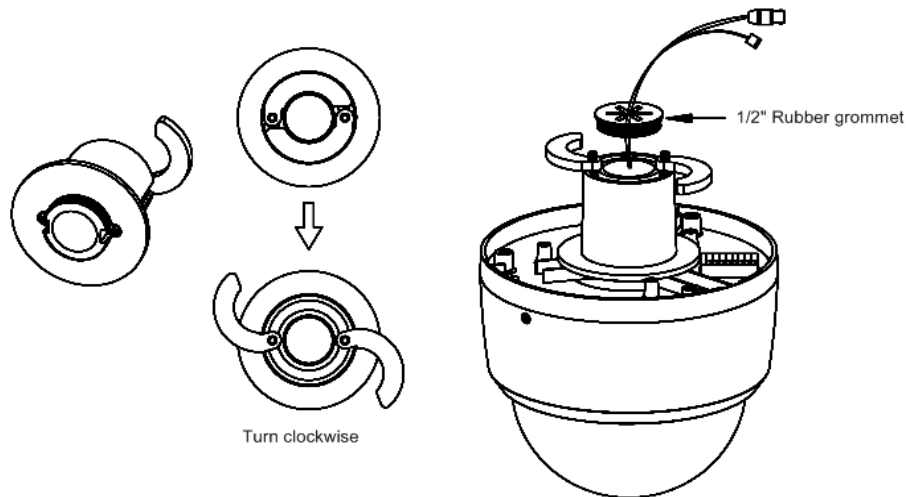

2.2 Connection

- **Connecting to the RJ-45**

Connect a standard RJ-45 cable to the network port of the network dome camera. Generally a cross-over cable is used for directly connection to PC, while a direct cable is used for connection to a hub.

- **Connecting Alarms**

AI(Alarm In) :

You can use external devices to signal the dome camera to react on events. Mechanical or electrical switches can be wired to the AI (Alarm In) and G (Ground) connectors.

G(Ground) :

Connect the ground side of the alarm input and/or alarm output to the G (Ground) connector.

AO(Alarm Out) :

The dome camera can activate external devices such as buzzers or lights. Connect the device to the AO (Alarm Out) and G (Ground) connectors.

- **Connecting Video Output**

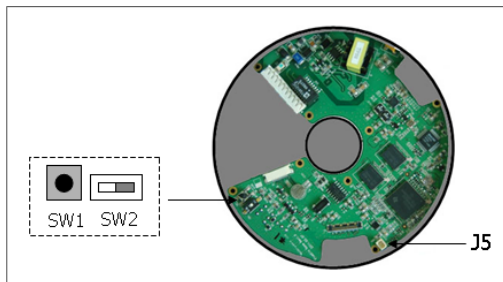

Video Output is used for an easy zoom and focus control when installing lens. Set Video Switch (SW2 on the board) to On position to output the video signal. Video Output is restricted to VGA(640x480) resolution.

Connect your Video cable unit to J5 on the board.

Caution: After lens installation, you must set Video Switch to Off position to provide the best performance of the Network Camera.

- **Connecting the Power**

Connect the power of DC12V 330mA for the network camera. Connect the positive(+) pole to the '+' position and the negative(-) pole to the '-' position.

2.3 Network Connection and IP assignment

The Network Camera supports the operation through the network. When a camera is first connected to the network it has no IP address. So, it is necessary to allocate an IP address to the device with the "Smart Manager" utility on the CD.

1. Connect the Network Camera / device to the network and power up.

2. Start SmartManager utility (Start>All programs> SmartManager >SmartManager), the main window will be displayed, after a short while any network devices connected to the network will be displayed in the list.

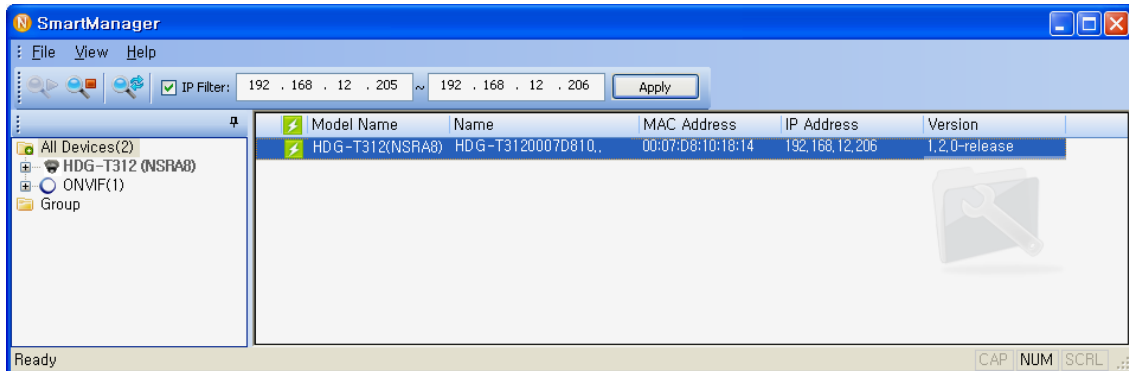

3. Select the camera on the list and click right button of the mouse. You can see the pop-up menu as below.

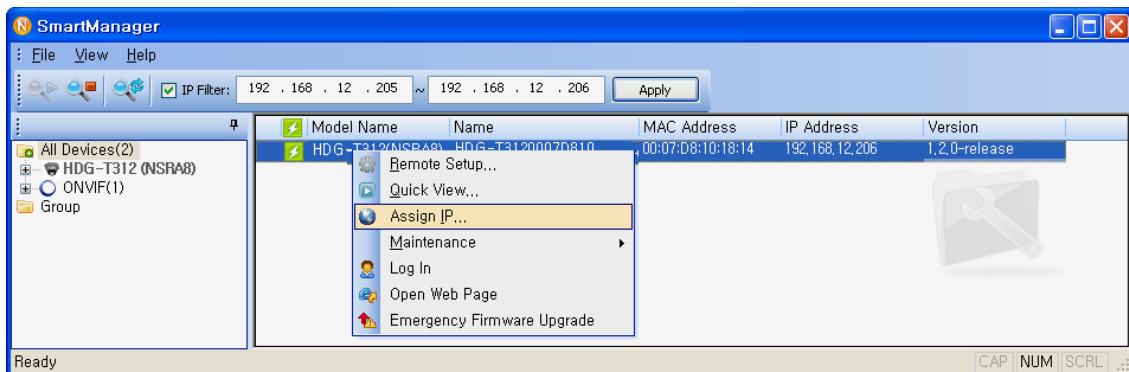

4. Select Assign IP. You can see a Assign IP window. Enter the required IP address.



Note: For more information, refer to the Smart Manger User's Manual.

3. Operation

The Network Camera can be used with Windows operating system and browsers. The recommended browsers are Internet Explorer, Safari, Firefox, Opera and Google Chrome with Windows.

Note: To view streaming video in Microsoft Internet Explorer, set your browser to allow ActiveX controls.

3.1 Access from a browser

1. Start a browser (Internet Explorer).
2. Enter the IP address or host name of the Network Camera in the Location/Address field of your browser.
3. You can see a starting page. Click Live View, Playback or Setup to enter web page.



4. The encoder's **Live View** page appears in your browser.

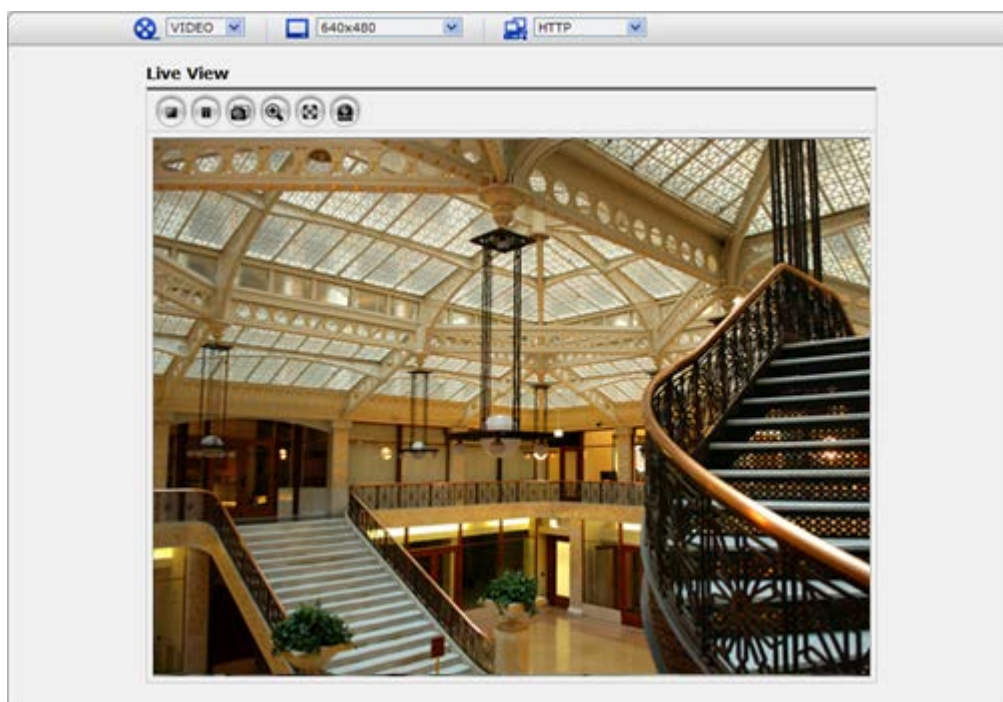

3.2. Access from the internet

Access from the internet once connected, the Network Camera is accessible on your local network (LAN). To access the video encoder from the Internet you must configure your broadband router to allow incoming data traffic to the video encoder. To do this, enable the NAT-traversal feature, which will attempt to automatically configure the router to allow access to the video encoder. This is enabled from Setup > System > Network > NAT.

For more information, please see “3.5.4 System>Network>NAT” of User’s Manual.

3.3 Setting the admin password over a secure connection

To gain access to the product, the password for the default administrator user must be set. This is done in the “Admin Password” dialog, which is displayed when the network camera is accessed for the setup at the first time. Enter your admin name and password, set by the administrator.

Note: The default administrator username and password is “admin”. If the password is lost, the Network Camera must be reset to the factory default settings. See “3.8 Resetting to the Factory Default Settings” for more details.

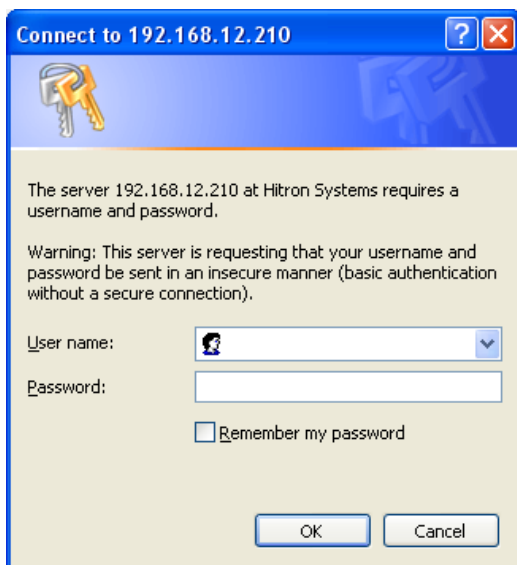

To prevent network eavesdropping when setting the admin password, this can be done via an encrypted HTTPS connection, which requires an HTTPS certificate (see note below).

To set the password via a standard HTTP connection, enter it directly in the first dialog shown below. To set the password via an encrypted HTTPS connection, see “3.5.4 System > Security > HTTPS”.



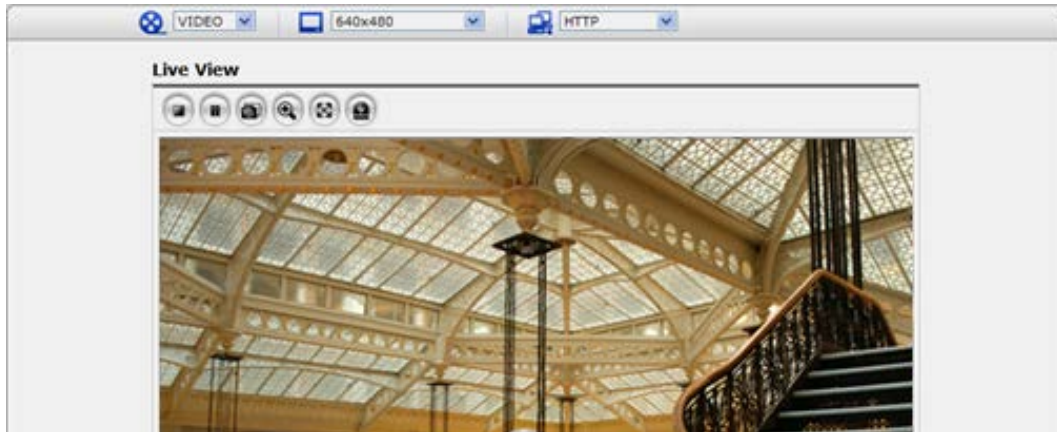

Note: HTTPS (Hypertext Transfer Protocol over SSL) is a protocol used to encrypt the traffic between web browsers and servers. The HTTPS certificate controls the encrypted exchange of information.

3.4 Live View Page

The live view page comes in eight screen modes like 1920x1080, 1280x1024, 1280x720, 704x480(576), 640x480, 352x240(288), and 320x240. Users are allowed to select the most suitable one out of those modes. Please, adjust the mode in accordance with your PC specifications and monitoring purposes.



1) General controls

 Live View Page  Search & Playback Page  Setup Page  Help Page

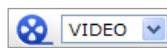

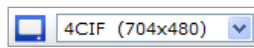

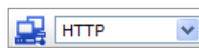

 The video drop-down list allows you to select a customized or pre-programmed video stream on the live view page. Stream profiles are configured under Setup > Basic Configuration > Video & Image. For more information, please see "3.5.1 Basic Configuration > Video & Image" of User's Manual.

 The resolution drop-down list allows you to select the most suitable one out of video resolutions to be displayed on live view page.

 The protocol drop-down list allows you to select which combination of protocols and methods to use depends on your viewing requirements, and on the properties of your network.

2) Control toolbar

The live viewer toolbar is available in the web browser page only. It displays the following buttons:

-  The Stop button stops the video stream being played. Pressing the key again toggles the start and stop. The Start button connects to the network camera or start playing a video stream.
-  The Pause button pause the video stream being played.
-  The Snapshot button takes a snapshot of the current image. The location where the image is saved can be specified.
-  The digital zoom activates a zoom-in or zoom-out function for video image on the live screen.
-  The Full Screen button causes the video image to fill the entire screen area. No other windows will be visible. Press the 'Esc' button on the computer keyboard to cancel full screen view.
-  The Manual Trigger button activates a pop-up window to manually start or stop the event.

3) Video Streams

The Network Camera provides several images and video stream formats. Your requirements and the properties of your network will determine the type you use.

The Live View page in the Network Camera provides access to H.264, MPEG-4 and Motion JPEG video streams, and to the list of available video streams. Other applications and clients can also access these video streams/images directly, without going via the Live View page.

3.5 Network Camera Setup

This section describes how to configure the network camera, and is intended for product Administrators, who have unrestricted access to all the Setup tools; and Operators, who have access to the settings for Basic, Live View, Video & Image, Audio, Event, and System Configuration.

You can configure the network camera by clicking Setup in the top right-hand corner of the Live View page. Click on this page to access the online help that explains the setup tools

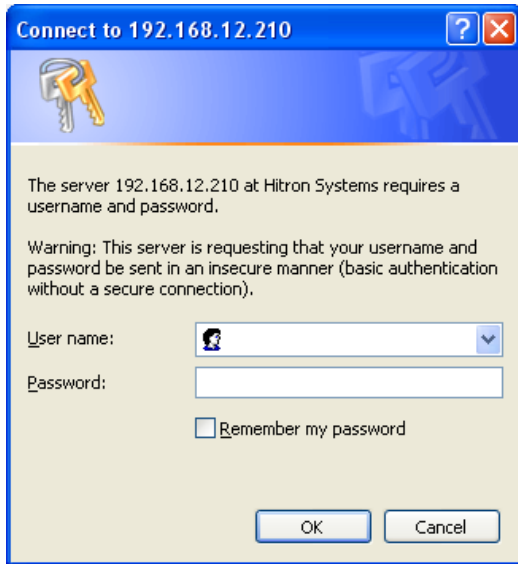

When accessing the Network Camera for the first time, the “Admin Password” dialog appears. Enter your admin name and password, set by the administrator.

Note: If the password is lost, the Network Camera must be reset to the factory default settings. See “3.8 Resetting to the Factory Default Settings”

3.5.1 Basic Configuration

1) Users

User access control is enabled by default. An administrator can set up other users, by giving these user names and passwords. It is also possible to allow anonymous viewer login, which means that anybody may access the Live View page, as described below:

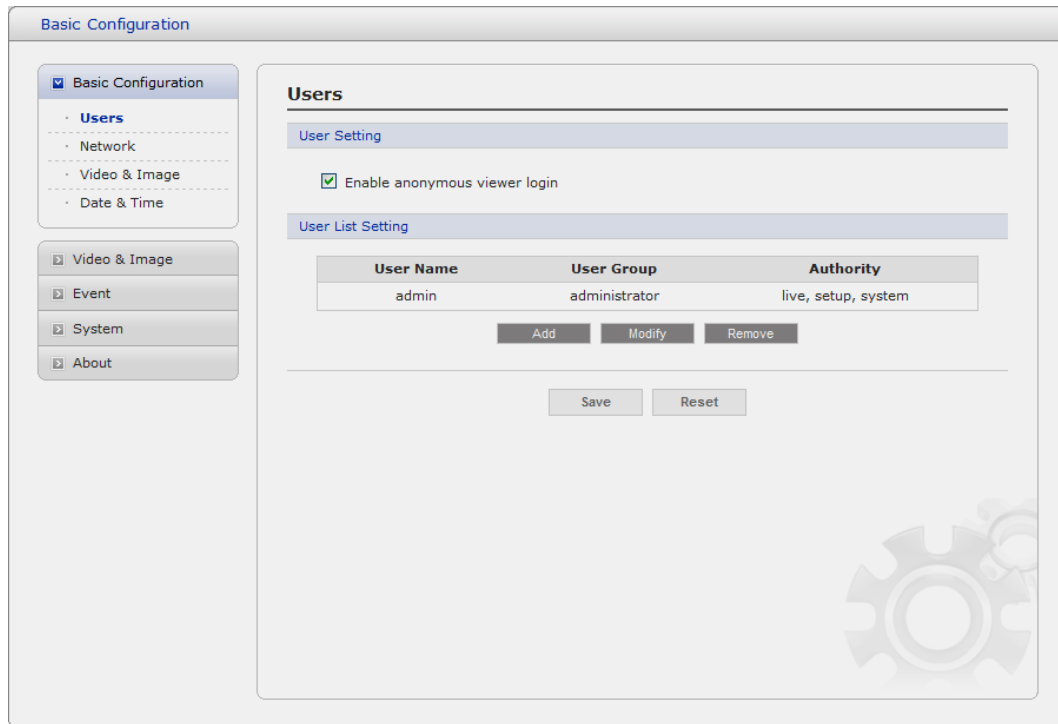

The **user list** displays the authorized users and user groups (levels):

User Group	Authority
Guest	Provides the lowest level of access, which only allows access to the Live View page.
Operator	An operator can view the Live View page, create and modify events, and adjust certain other settings. Operators have no access to System Options.
Administrator	An administrator has unrestricted access to the Setup tools and can determine the registration of all other users.

- **Enable anonymous viewer login:** Check the box to use the webcasting features. Refer to "3.5.2 Video & Image" for more details.

2) Network

The network camera support both IP version 4 and IP version 6. Both versions may be enabled simultaneously, and at least one version must always be enabled. When using IPv4, the IP address for the video encoder can be set automatically via DHCP, or a static IP address can be set manually. If IPv6 is enabled, the video encoders receive an IP address according to the configuration in the network router. There is also the option of using the Internet Dynamic DNS Service. For more information on setting the Network, please see Setup> System>Security>Network.

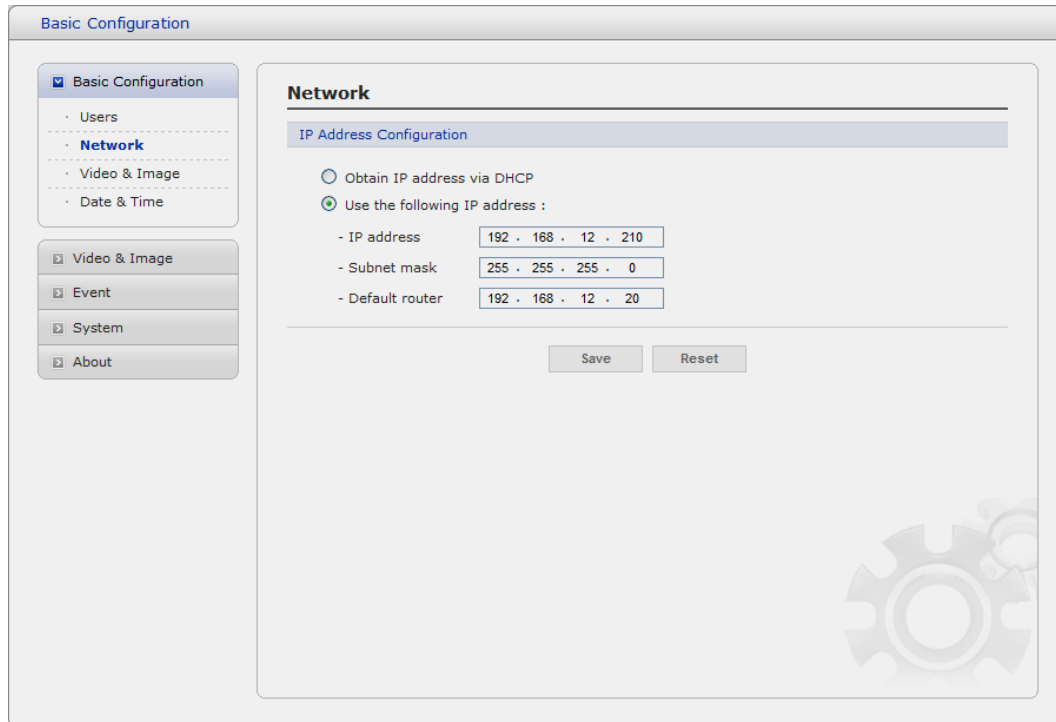

The screenshot shows a web-based configuration interface for a network camera. The main heading is 'Basic Configuration'. On the left, there is a sidebar menu with options: 'Basic Configuration' (selected), 'Users', 'Network' (highlighted), 'Video & Image', 'Date & Time', 'Video & Image', 'Event', 'System', and 'About'. The main content area is titled 'Network' and contains a sub-section 'IP Address Configuration'. There are two radio buttons: 'Obtain IP address via DHCP' (unselected) and 'Use the following IP address:' (selected). Below the selected option, there are three input fields: 'IP address' with the value '192 . 168 . 12 . 210', 'Subnet mask' with '255 . 255 . 255 . 0', and 'Default router' with '192 . 168 . 12 . 20'. At the bottom of the form are 'Save' and 'Reset' buttons. A faint gear icon is visible in the background of the main content area.

- **Obtain IP address via DHCP** - Dynamic Host Configuration Protocol (DHCP) is a protocol that lets network administrators centrally manage and automate the assignment of IP addresses on a network. DHCP is enabled by default. Although a DHCP server is mostly used to set an IP address dynamically, it is also possible to use it to set a static, known IP address for a particular MAC address.
- **Use the following IP address** - To use a static IP address for the Network Camera, check the radio button and then make the following settings:
 - **IP address:** Specify a unique IP address for your Network Camera.
 - **Subnet mask:** Specify the mask for the subnet the Network Camera is located on.
 - **Default router:** Specify the IP address of the default router (gateway) used for connecting devices attached to different networks and network segments.

Notes:

1. DHCP should only be enabled if using dynamic IP address notification, or if your DHCP server can update a DNS server, which then allows you to access the Network Camera by name (host name). If DHCP is enabled and you cannot access the unit, you may have to reset it to the factory default settings and then perform the installation again.
2. The ARP/Ping service is automatically disabled two minutes after the unit is started, or as soon as an IP address is set.
3. Pinging the unit is still possible when this service is disabled.

3) Video & Image

The screenshot shows a web interface for 'Basic Configuration'. On the left is a navigation menu with 'Basic Configuration' selected, and sub-items for 'Users', 'Network', 'Video & Image', and 'Date & Time'. Below this are buttons for 'Video & Image', 'Event', 'System', and 'About'. The main area is titled 'Video & Image' and contains three sections: 'Stream 1 Setting', 'Stream 2 Setting', and 'Stream 3 Setting'. 'Stream 1 Setting' includes fields for Codec (H.264 Baseline Profile), Resolution (4CIF (704x480)), Bitrate control (CBR), Bitrate (2000 [Kbps]), Framerate (30), and GOP size (30 [1...60]). 'Stream 2 Setting' includes Codec (MJPEG), Resolution (VGA (640x480)), Framerate (30), and Quality (50 [1...100]). 'Stream 3 Setting' has an 'Enable Stream 3' checkbox (unchecked), Codec (H.264 Baseline Profile), Resolution (Depend on Stream 2), Bitrate control (CBR), Bitrate (2000 [Kbps]), Framerate (30), and GOP size (30 [1...60]). At the bottom right are 'Save' and 'Reset' buttons.

- **Stream1 Setting**

- **Codec:**

The codec settings are separated into MPEG4 and H.264.

H.264 is also known as MPEG-4 Part 10. This is the new generation compression standard for digital video. This function offers higher video resolution than Motion JPEG or MPEG-4 at the same bit rate and bandwidth, or the same quality video at a lower bit rate.

There are 4 pre-programmed stream profiles available for quick set-up. Choose the form of video encoding you wish to use from the drop-down list:

- * **H.264 HP(High Profile):** The primary profile for broadcast and disc storage applications, particularly for high-definition television applications (for example, this is the profile adopted by the Blu-ray Disc storage format and the DVB HDTV broadcast service).

- * **H.264 MP(Main Profile):** Primarily for low-cost applications that requires additional error robustness, this profile is used rarely in videoconferencing and mobile applications, it does add additional error resilience tools to the Constrained Baseline Profile. The importance of this profile is fading after the Constrained Baseline Profile has been defined.

- * **H.264 BP(Baseline Profile):** Originally intended as the mainstream consumer profile for broadcast and storage applications, the importance of this profile faded when the High profile was developed for those applications.

- * **MPEG4 SP(Simple Profile):**
Mostly aimed for use in situations where low bit rate and low resolution are mandated by other conditions of the applications, like network bandwidth, device size etc.
- **Resolution:**
It enables users to determine a basic screen size when having an access through the Web Browser or PC program. The screen size control comes in seven modes like 1920x1080, 1280x1024, 1280x720, 704x480(576), 640x480, 352x240(288), and 320x240. Users can reset the selected screen size anytime while monitoring the screen on a real-time basis.
- **Bitrate control:**
The bit rate can be set as Variable Bit Rate (VBR) or Constant Bit Rate (CBR). VBR adjusts the bit rate according to the image complexity, using up bandwidth for increased activity in the image, and less for lower activity in the monitored area.

CBR allows you to set a fixed target bitrate that consumes a predictable amount of bandwidth. As the bit rate would usually need to increase for increased image activity, but in this case cannot, the frame rate and image quality are affected negatively. To partly compensate for this, it is possible to prioritize either the frame rate or the image quality whenever the bit rate needs to be increased. Not setting a priority means the frame rate and image quality are equally affected.
- **Bitrate:**
When it is necessary to adjust a smooth transmission status according to network situations, users can increase the compressibility to carry out the network transmission stably. On the other hand, when it is necessary to maintain a detailed monitoring screen by enhancing the image quality, users can do so by decreasing the compressibility. In ease case, please adjust this function according to the network status and monitoring purposes. The default is 2000(Kbps).
- **Frame rate:**
Upon the real-time play, users should select a frame refresh rate per second. If the rate is high, the image will become smooth. On the other hand, if the rate is low, the image will not be natural but it can reduce a network load.
- **GOP size:**
Select the GOP(Group of Picture) size. If users want to have a high quality of fast image one by one, please decrease the value. For the purpose of general monitoring, please do not change a basic value. Such act may cause a problem to the system performance. For the details of GOP setting, please contact the service center.
- **Stream2 Setting**
Sometimes the image size is large due to low light or complex scenery. Adjusting the frame rate and quality helps to control the bandwidth and storage used by the Motion JPEG video stream in these situations. Limiting the frame rate and quality optimizes bandwidth and storage usage, but may give poor image quality. To prevent increased bandwidth and storage usage, the Resolution, Frame rate, and Frame Quality should be set to an optimal value.
 - **JPEG resolution:** Same as the Stream1 Setting.
 - **JPEG frame rate:** Same as the Stream1 Setting.

- **JPEG quality:**
Select the picture quality. If users want to have a high quality of fast image one by one, please decrease the value. For the purpose of general monitoring, please do not change a basic value. Such act may cause a problem to the system performance.

- **Stream3 Setting**

Same as the Stream1 Setting. Click the checkbox to activate the 3rd stream.

When satisfied with the settings, click **Save**, or click **Reset** to revert to previously saved settings.

4) Date & Time

The screenshot shows a web interface for 'Basic Configuration'. On the left, a sidebar lists menu items: Basic Configuration (selected), Users, Network, Video & Image, Date & Time, Video & Image, Event, System, and About. The main content area is titled 'Date & Time' and contains the following sections:

- Current Server Time:** Date: 2010-07-29, Time: 12:20:41
- New Server Time:**
 - Time zone: (GMT+09:00) Seoul (dropdown menu)
 - Automatically adjustment for daylight saving time changes
 - Time mode:
 - Synchronize with computer time (Date: 2010-07-29, Time: 12:20:59)
 - Synchronize with NTP server (NTP server: time.nist.gov, NTP Interval: 12 [hour])
 - Set manually (Date: 2010-07-29, Time: 12:19:33)
- Date & Time Format:**
 - Date Format: YYYY-MM-DD (dropdown menu)
 - Time Format: 24 Hour (dropdown menu)

At the bottom of the main content area are 'Save' and 'Reset' buttons.

- **Current Server Time**

It displays the current date and time (24h clock). The time can be displayed in 12h clock format in the overlay (see below).

- **New Server Time**

Select your time zone from the drop-down list. If you want the server clock to automatically adjust for daylight savings time, select the "Automatically adjustment for daylight saving time changes".

From the **Time Mode** section, select the preferred method to use for setting the time:

- **Synchronize with computer time:** sets the time from the clock on your computer.
- **Synchronize with NTP Server:** the video encoder will obtain the time from an NTP server every 60 minutes.
- **Set manually:** this option allows you to manually set the time and date.

3.5.2 Video & Image

▼ Basic

The screenshot displays the 'Video & Image' configuration window. On the left is a sidebar with a tree view containing 'Basic Configuration', 'Video & Image' (selected), 'Event', 'System', and 'About'. Under 'Video & Image', there are sub-items: 'Basic', 'Image', 'Privacy Masking', and 'Webcasting'. The main area is titled 'Video & Image - Basic' and contains three sections for stream settings:

- Stream 1 Setting:** Codec: H.264 Baseline Profile; Resolution: 4CIF (704x480); Bitrate control: CBR; Bitrate: 2000 [Kbps]; Framerate: 30; GOP size: 30 [1 ...60].
- Stream 2 Setting:** Codec: MJPEG; Resolution: VGA (640x480); Framerate: 30; Quality: 50 [1 ...100].
- Stream 3 Setting:** Enable Stream 3; Codec: H.264 Baseline Profile; Resolution: Depend on Stream 2; Bitrate control: CBR; Bitrate: 2000 [Kbps]; Framerate: 30; GOP size: 30 [1 ...60].

At the bottom right of the main area, there is a 'Save' button, a 'Reset' button, and a decorative graphic of a film reel and clapperboard.

Refer to "3.5.1 Basic Configuration > Video & Image" for more details.

▼ Appearance

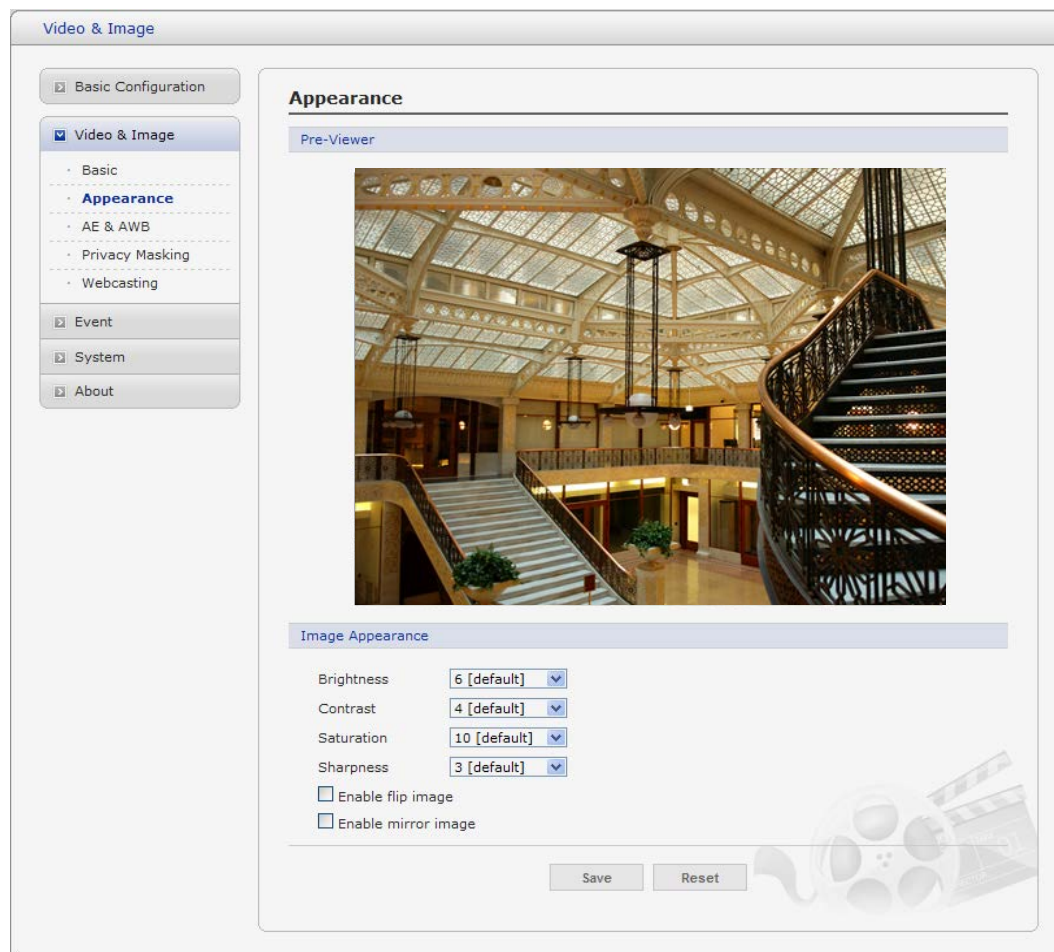

- **Appearance**

This page provides access to the advanced image settings for the network camera.

- **Brightness:** The image brightness can be adjusted in the range 1-10, where a higher value produces a brighter image.
- **Color level:** Select an appropriate level by entering a value in the range 1-10. Lower values mean less color saturation.
- **Saturation:** Adjust the image's contrast by raising or lowering the value in this field.
- **Sharpness:** Controls the amount of sharpening applied to the image. A sharper image might increase image noise especially in low light conditions. A lower setting reduces image noise, but the image would be less sharp.
- **Enable flip image:** Check this checkbox to flip the image.
- **Enable mirror image:** Check this checkbox to mirror the image.

▼ AE & AWB

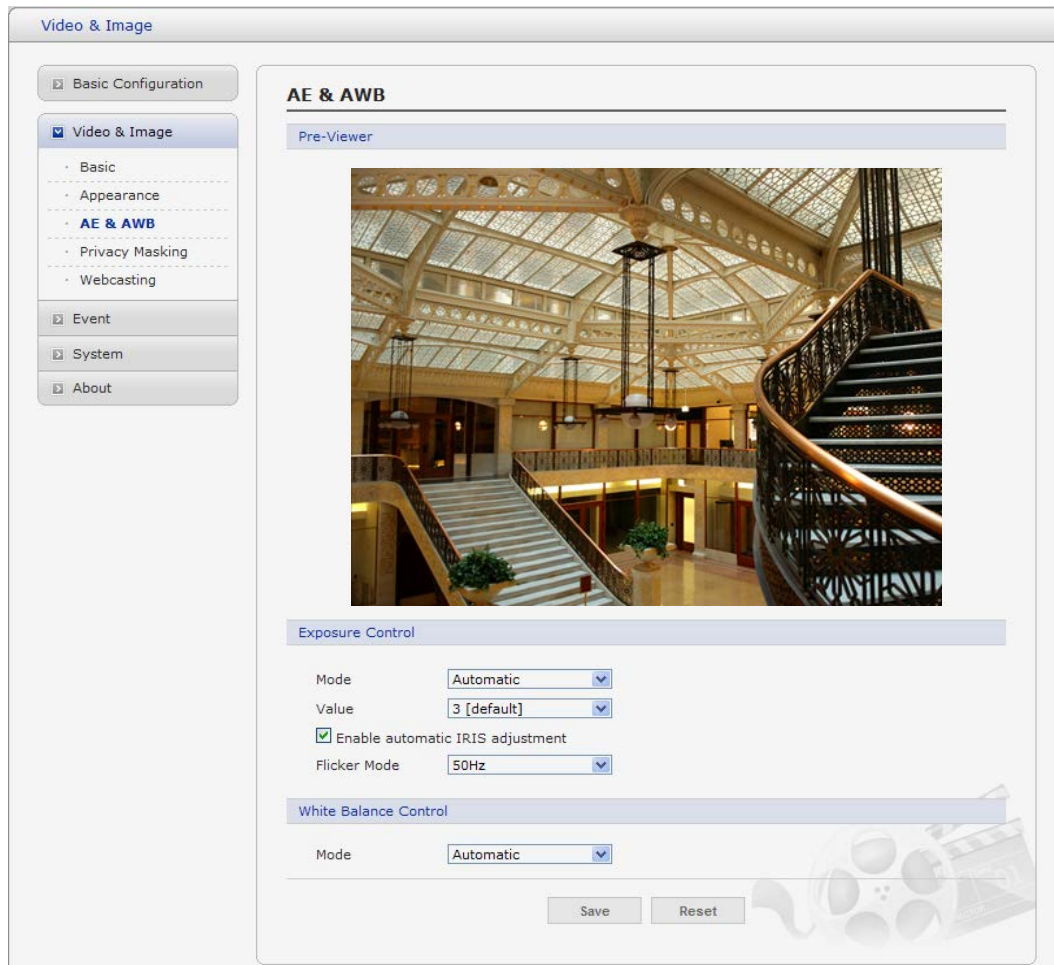

This page provides access to set the exposure and white balance of the network camera.

- **Exposure Control**

Configure the exposure settings to suit the image quality requirements in relation to lighting consideration.

- **Mode:** Supports exposure modes to control the amount of light detected by the camera sensor based on settings for light conditions. The default setting is Auto with DC-IRIS.
 - * **Automatic:** Automatically sets the amount of light detected by the DC-IRIS and AGC.
 - * **Hold Current:** Fixes the exposure at its current state.
- **Value:** Select a value in the drop-down list to tune the exposure. The default setting is 3.
- **Enable automatic IRIS adjustment:** This checkbox should always be set to be **checked**, except during focusing, or when using a fixed iris lens.
- **Flicker Mode:** Provides the options for flicker.
 - * **50Hz:** Select at 50 Hz environments.
 - * **60Hz:** Select at 60 Hz environments.

- **White Balance Control**

This adjusts the relative amount of red, green and blue primary colors in the image so that the neutral colors are reproduced correctly. The camera can be set to automatically adjust for the type of light and compensate for its color. Alternatively, the type of light source can be set manually.

From the drop-down list, select the white balance setting suitable for the lighting used for your camera. The available options are:

- **Automatic:** Automatic identification and compensation for the light source color. This can be used in most situations and is the recommended setting.
- **Fixed Indoor:** Fixed color adjustment, ideal for a room with incandescent (a glow) lighting and good for a normal color temperature around 2600K.
- **Fixed Fluorescent 1:** Fixed color adjustment; good for fluorescent lighting with a color temperature around 4000K.
- **Fixed Fluorescent 2:** Fixed color adjustment; good for fluorescent lighting with a color temperature around 5000K.
- **Fixed Outdoor 1:** Fixed color adjustment for sunny, with a color temperature around 6500K.
- **Fixed Outdoor 2:** Fixed color adjustment for cloudy, with a color temperature around 7500K.

▼ Day & Night

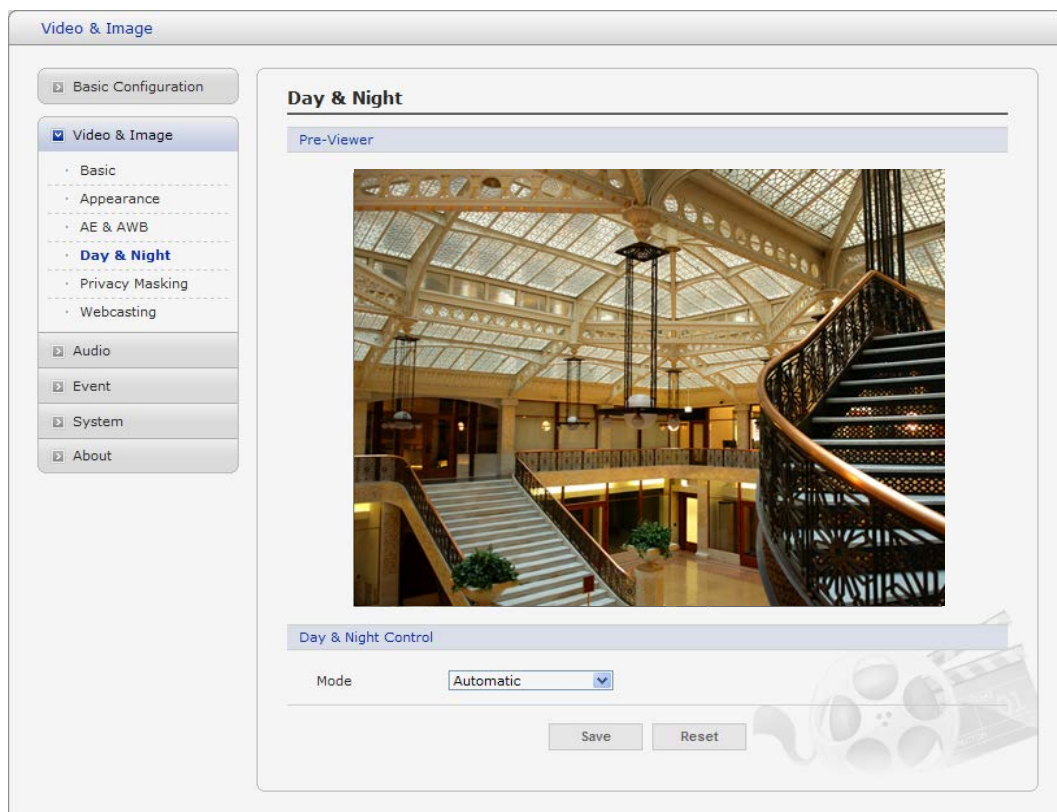

Select the day/night mode from among three modes.

- **Automatic:** Normally works in day mode. It switches automatically to night mode in a dark place.
- **Day:** Always works in day mode.
- **Night:** Always works in night mode.

▼ Privacy Masking

The privacy masking function allows you to mask parts of the video image to be transmitted. You can set up to eight privacy masks and the color of privacy masks is black.

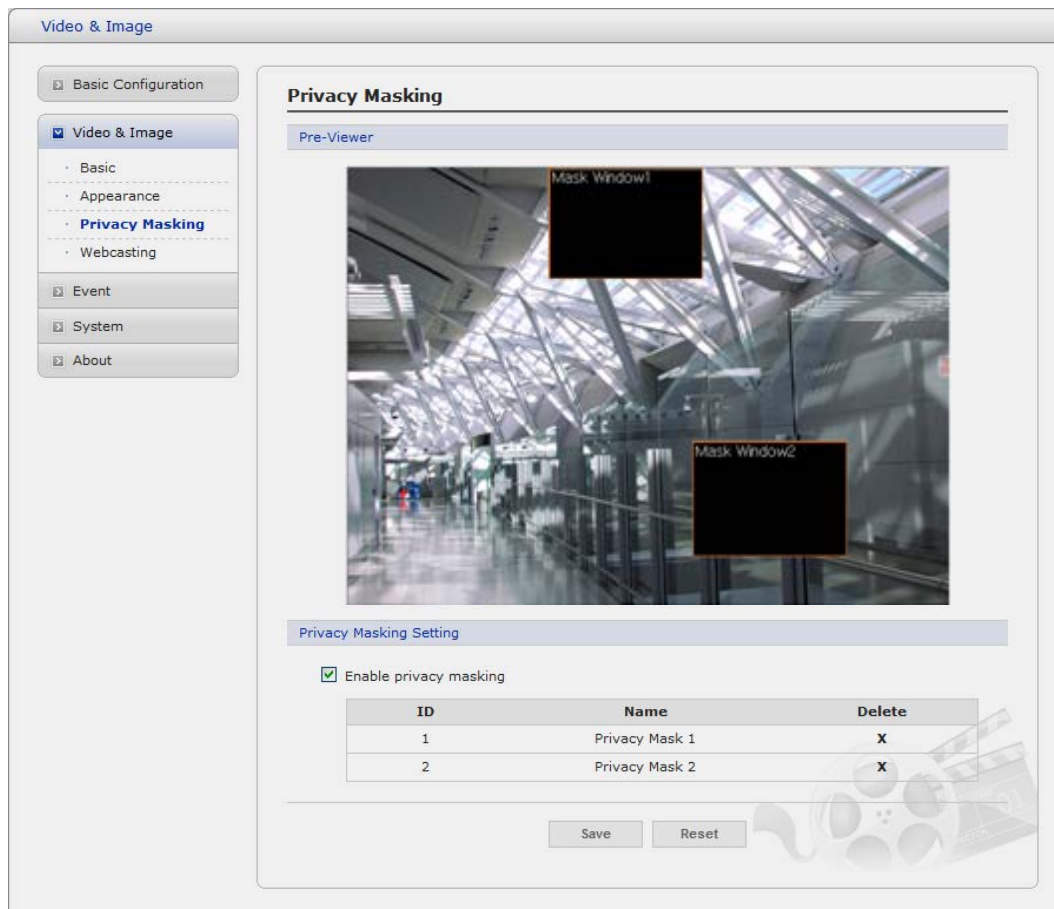

The privacy masks are configured by Mask windows. Each window can be selected by clicking with the mouse. It is also possible to **resize or delete, or move** the window, by selecting the appropriate window at the mouse menu on the video screen.



To create a mask window, follow steps:

1. Click the right button of mouse to see the mouse menu.
2. Select New Privacy Mask in the mouse menu.
3. Click and drag mouse to designate a mask window area.

You can also modify or delete a motion index. Select an index and then, modify items or delete button. Select "Enable" to activate the privacy masking function.

▼ Webcasting

The network camera can stream live video to a website. Copies the HTML code generated on the screen and paste it in page code of the website you want to display live video.

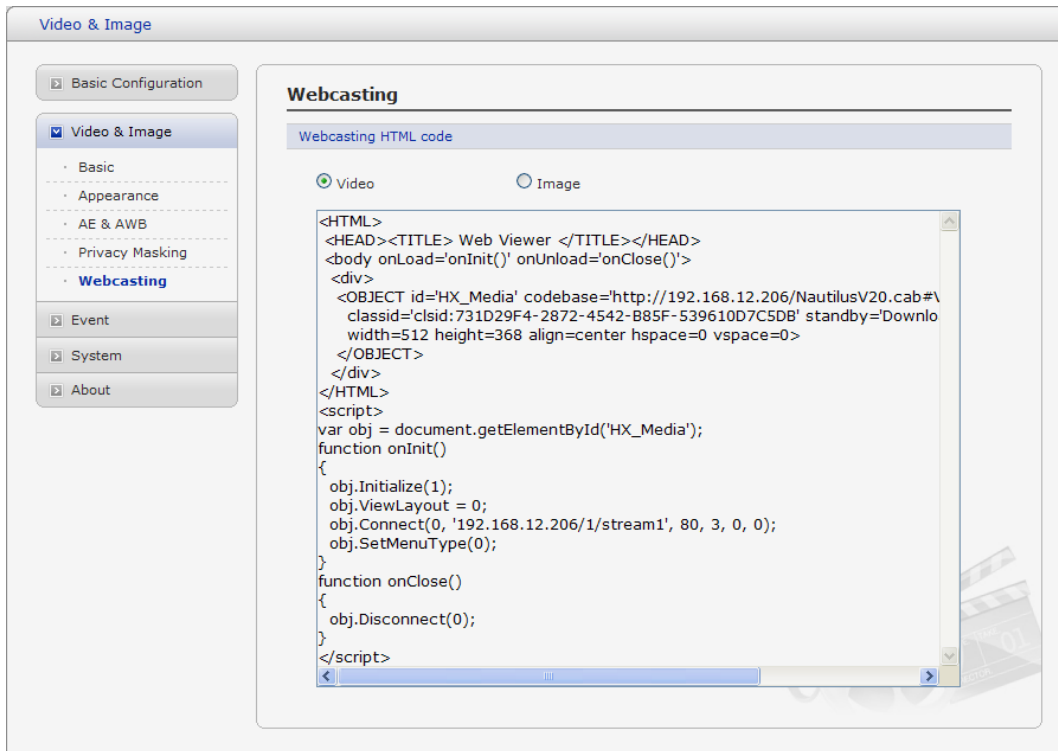

The screenshot shows a web interface for configuring video and image settings. On the left, a sidebar contains a menu with options: Basic Configuration, Video & Image (selected), Event, System, and About. Under 'Video & Image', there are sub-options: Basic, Appearance, AE & AWB, Privacy Masking, and Webcasting (selected). The main area is titled 'Webcasting' and has a sub-section 'Webcasting HTML code'. Below this, there are two radio buttons: 'Video' (selected) and 'Image'. A text area contains the following HTML and JavaScript code:

```
<HTML>
<HEAD><TITLE> Web Viewer </TITLE></HEAD>
<body onLoad='onInit()' onUnload='onClose()'>
<div>
<OBJECT id='HX_Media' codebase='http://192.168.12.206/NautilusV20.cab#\
classid='clsid:731D29F4-2872-4542-B85F-539610D7C5DB' standby='Downlo
width=512 height=368 align=center hspace=0 vspace=0>
</OBJECT>
</div>
</HTML>
<script>
var obj = document.getElementById('HX_Media');
function onInit()
{
obj.Initialize(1);
obj.ViewLayout = 0;
obj.Connect(0, '192.168.12.206/1/stream1', 80, 3, 0, 0);
obj.SetMenuType(0);
}
function onClose()
{
obj.Disconnect(0);
}
</script>
```

Note: To use webcasting service, the Enable Anonymous viewer login option must be checked. Refer to "3.6.1 Basic Configuration > Users" for more details.

3.5.3 Event

1) Event-In

▼ On Boot

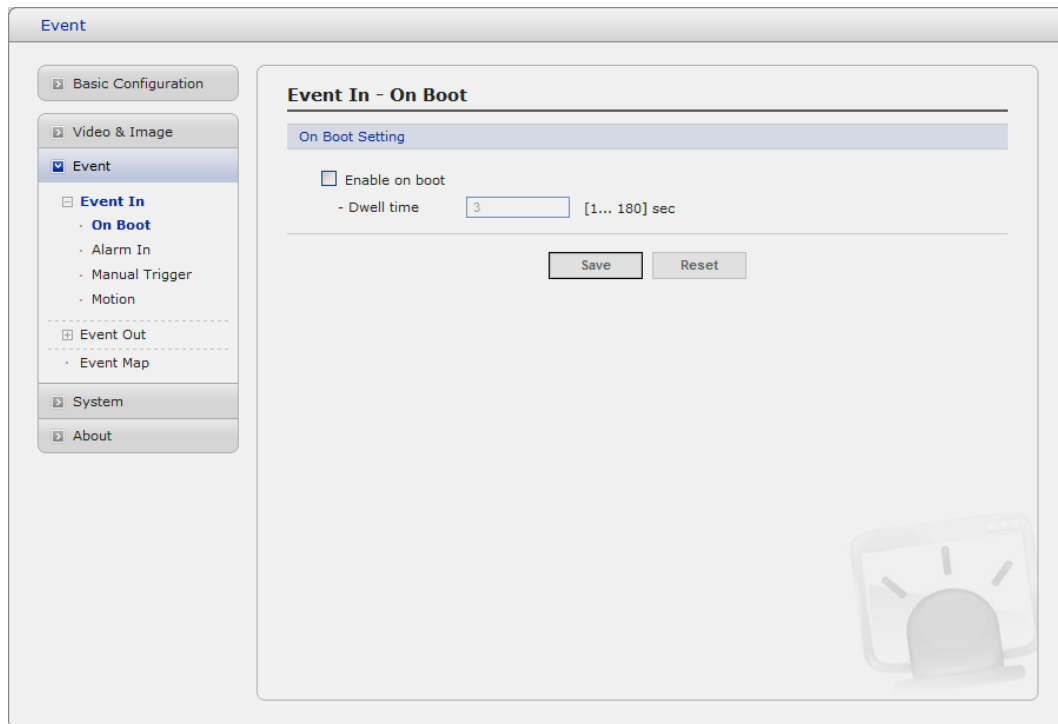

This is used to trigger the event every time the Network Transmitter is started. Select "Enable" to activate the motion event.

▼ Alarm In

The screenshot displays a web-based configuration interface for an alarm system. The main heading is "Event In - Alarm In". Below this, there is a sub-section titled "Alarm In Port 1 Setting". This section contains the following controls:

- An unchecked checkbox labeled "Enable alarm in port 1".
- A dropdown menu for "Type" currently showing "NO".
- An input field for "Dwell time" containing the value "3", with a range indicator "[1... 180] sec" to its right.

At the bottom of the configuration area, there are two buttons: "Save" and "Reset".

The left sidebar shows a navigation menu with the following items:

- Basic Configuration
- Video & Image
- Event (selected)
- Event In
 - On Boot
 - Alarm In (selected)
 - Manual Trigger
 - Motion
- Event Out
 - Event Map
- System
- About

Select "Enable" to activate the alarm event. The network camera support 1 alarm input ports.

- **Type:** Choose the type of alarm you wish to use from the drop-down list.
- **Dwell Time:** Set the dwell time an event lasts for the specified dwell time from the point of detection of an alarm input.

▼ Manual Trigger

The screenshot displays a web interface for configuring manual triggers. On the left, a sidebar menu is visible with categories: Basic Configuration, Video & Image, Event (selected), Event Out, System, and About. Under the 'Event' category, sub-items include Event In (selected), On Boot, Alarm In, Manual Trigger (highlighted), and Motion. The main content area is titled 'Event In - Manual Trigger' and contains four sections for individual trigger settings:

- Manual Trigger 1 Setting:** Enable manual trigger 1. Dwell time: 3 [1... 180] sec.
- Manual Trigger 2 Setting:** Enable manual trigger 2. Dwell time: 3 [1... 180] sec.
- Manual Trigger 3 Setting:** Enable manual trigger 3. Dwell time: 3 [1... 180] sec.
- Manual Trigger 4 Setting:** Enable manual trigger 4. Dwell time: 3 [1... 180] sec.

At the bottom of the configuration area, there are 'Save' and 'Reset' buttons. A faint bell icon is visible in the bottom right corner of the main content area.

This option makes use of the manual trigger button provided on the live view page, which are used to start or stop the event type manually. Alternatively the event can be triggered via the product's API (Application Programming Interface).

▼ Motion

Event In - Motion

Pre-Viewer

Video Motion Detection Setting

Enable video motion detection

ID	Name	Type	Threshold	Sensitivity	Dwell	Delete
1	VMD1	Include	50	50	5	X
2	VMD2	Include	50	50	5	X

Save Reset

Motion detection is used to generate an alarm whenever movement occurs (or stops) in the video image. A total of 8 Motion and/or Mask windows can be created and configured.

Motion is detected in defined **Motion** windows, which are placed in the video image to target specific areas. Movement in the areas outside the motion windows will be ignored. If part of a motion window needs to be masked, this can be configured in a **Mask** window.

- **Pre-Viewer**
Motion detection windows are configured by Motion or Mask windows. Each window can be selected by clicking with the mouse. It is also possible to **resize or delete, or move** the window, by selecting the appropriate window at the mouse menu on the video screen.

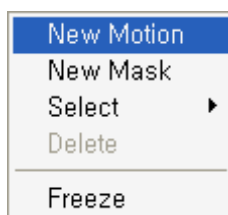

To create a motion or mask window, follow steps:

1. Click the right button of mouse to see the mouse menu.
2. Select New Motion (or Mask) Window in the mouse menu.
3. Click and drag mouse to designate a motion area.

- **Motion Detection Setting**

The behavior for each window is defined by adjusting the Threshold and Sensitivity, as described below.

A motion index is a set of parameters describing Window Name, Type, Threshold, Sensitivity, and Dwell Time. Window Types is one of Motion and Mask windows.

- **Threshold:** Sets up the sensitivity for the motion detection.
- **Sensitivity:** Sets up the sensitivity for the motion detection.
- **Dwell Time:** Set the hold time an event lasts for the specified hold time from the point of detection of a motion.

You can also modify or delete a motion index. Select an index and then, click the Modify or Delete button.

Select "Enable" to activate the motion window.

▼ Network Loss

This is used to trigger the event every time the network connection is failed. Select "Enable" to activate the Network Loss event

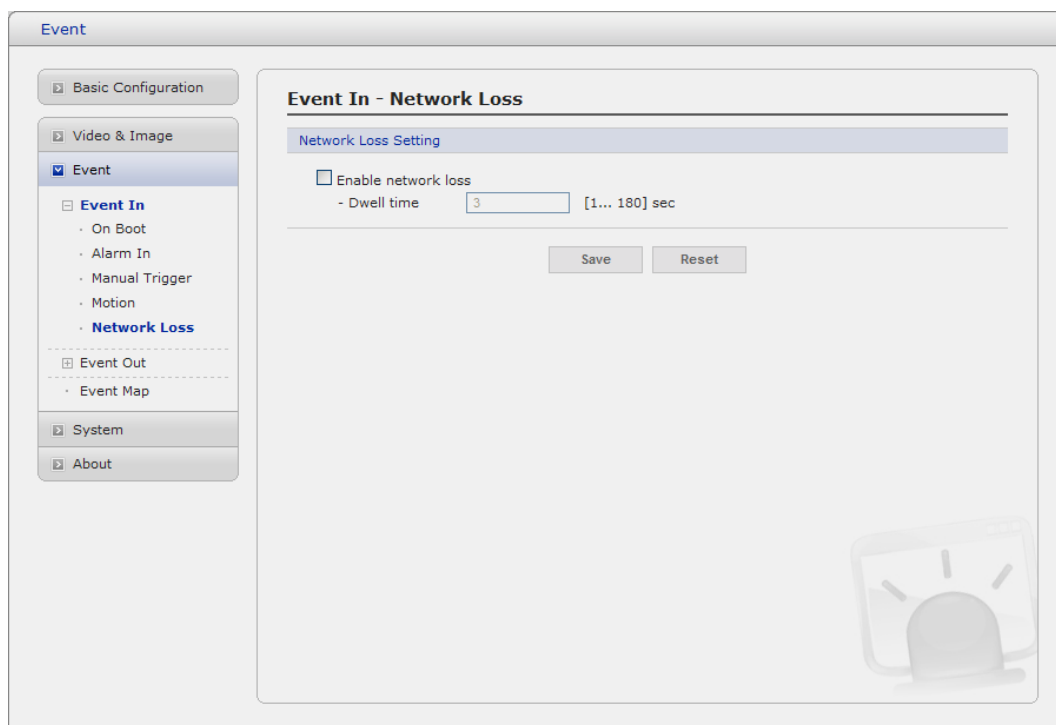

2) Event-Out

▼ SMTP(E-Mail)

The Network Camera can be configured to send event and error email messages via SMTP (Simple Mail Transfer Protocol).

- **SMTP(E-Mail) Setting**

Select "Enable" to activate the SMTP operation.

- **Mail Server/Port:** Enter the host names (or IP addresses) and port numbers for your mail server in the fields provided, to enable the sending of notifications and image email messages from the camera to predefined addresses via SMTP.
- **Sender:** Enter the email address to be used as the sender for all messages sent by the Network Transmitter.
- **Interval:** Represents the frequency of the email notification when an event occurs.
- **Aggregate events:** Shows the maximum number of emails sent within each interval.

If your mail server requires authentication, check the box for Use authentication to log in to this server and enter the necessary information.

- **User Name/Password:** Enter the User Name and Password as provided by your network administrator or ISP (Internet Service Provider).

To ensure that the login procedure is performed as securely as possible when using SMTP authentication, you must define the weakest authentication method allowed.

- **Login Method:** Set the Weakest method allowed to the highest/safest method supported by the mail server. The most secure method is listed in the drop-down list: Login / Plain
- **SMTP(E-Mail) Receiver**
 - **Receiver:** Enter an email address. You can also register the e-mail address of recipients up to 8.
- **SMTP(E-Mail) Test**
 - **Receiver:** Enter an email address and click the Test button to test that the mail servers are functioning and that the email address is valid.

▼ FTP & JPEG

The screenshot shows a web-based configuration interface for a network camera. On the left is a sidebar menu with categories: Basic Configuration, Video & Image, Event, System, and About. The 'Event' category is expanded, showing sub-items: Event In, Event Out (selected), SMTP(E-Mail), FTP & JPEG (highlighted), HTTP Server, Alarm Out, Record, and Event Map. The main content area is titled 'Event Out - FTP & JPEG' and contains two sections: 'FTP Setting' and 'JPEG Setting'. The 'FTP Setting' section has an 'Enable FTP' checkbox, a 'Server' text box, a 'Port' text box with '21' entered, a 'Remote directory' text box, a 'User name' text box, a 'Password' text box, and an 'Anonymous login' checkbox. The 'JPEG Setting' section has 'Pre-event Time' and 'FPS' fields (both set to 5 and 1 respectively), 'Post-event Time' and 'FPS' fields (both set to 5 and 1 respectively), a 'Prefix file name' text box with 'basename_' entered, and radio buttons for 'Additional suffix' (None, Date/Time, Sequence number). At the bottom are 'Save' and 'Reset' buttons.

When the network camera detects an event, it can record and saves images to an FTP server. Images can be sent as e-mail attachments. Check the box to enable the service.

- **FTP Setting**
 - **Server:** Enter the server's IP address or host name. Note that a DNS server must be specified in the TCP/IP network settings if using a host name.
 - **Port:** Enter the port number used by the FTP server. The default is 21.
 - **Use passive mode:** Under normal circumstances the Network Camera simply requests the target FTP server to open the data connection. Checking this box issues a PASV command to the FTP server and establishes a passive FTP connection; whereby the Network Camera actively initiates both the FTP control and data connections to the target server. This is normally desirable if there is a firewall between the camera and the target FTP server.

- **Remote directory:** Specify the path to the directory where the uploaded images will be stored. If this directory does not already exist on the FTP server, there will be an error message when uploading.
- **User name/Password:** Provide your log-in information.
- **JPEG Setting**
 - **Pre-event:** A pre-event buffer contains images from the time immediately preceding the event trigger. These are stored internally in the server. This buffer can be very useful when checking to see what happened to cause the event trigger. Check the box to enable the pre-trigger buffer, enter the desired total length in seconds, minutes or hours, and specify the required image frequency.
 - **Post-event:** This function is the counterpart to the pre-trigger buffer described above and contains images from the time immediately after the trigger. Configure as for pre-event.
 - **Prefix file name:** This name will be used for all the image files saved. If suffixes are also used, the file name will take the form <prefix>.<suffix>.<extension>
 - **Additional suffix:** Add either a date/time suffix or, a sequence number - with or without a maximum value

▼ HTTP Server

When the network camera detects an event, HTTP Server is used to receive uploaded image files and/or notification messages. Check the box to enable the service.

- **HTTP Server Setting**
 - **Name:** The name of the HTTP event server. Use a descriptive name.
 - **URL:** The network address to the server and the script that will handle the request.
For example: <http://192.168.12.244/cgi-bin/upload.cgi>
 - **User name/Password:** Provide your log-in information.
- **HTTP Server Test**
When the setup is complete, the connection can be tested by clicking the Test button.

▼ Alarm Out

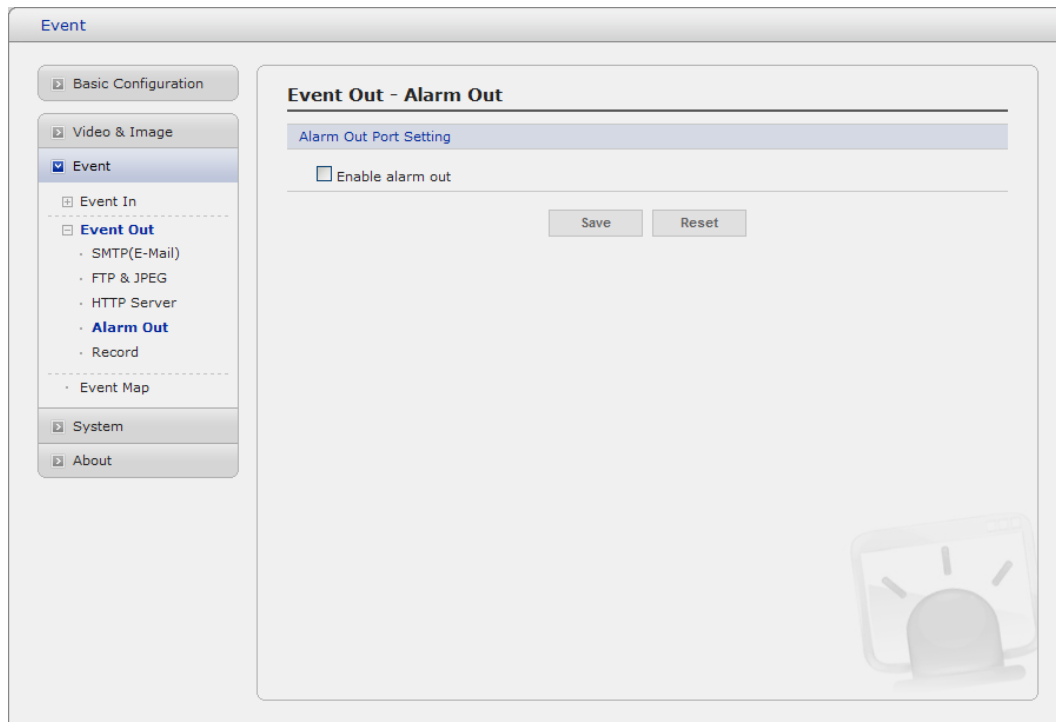

When the network camera detects an event, it can control external equipment connected to its alarm output port. Check the box to enable and then select either:

- **Enable:** When you select **“Enable alarm out”**, the output will be activated for as long as the event is active.

▼ Record

Event Out - Record

Record Setting

Enable Record

Overwrite

Continuous Record

* Note : Continuous Record is not available while using SD.

- Stream Type: Stream 1

- Pre-event: 0 [0... 10] sec

- Post-event: 0 [0... 60] sec

Device Setting

Device Type: SD

Format

Device Status : No Storage

Device Remove

Device Information

Total	Used	Available	Used Percent	Bad Sector
0.00MB	0.00MB	0.00MB	0.00%	0.00%

When the network camera detects an event, it can record video stream in the Micro SD Memory (not supplied) or NAS (Network Attached Device) as a storage device. Check the box to enable the service.

- **Record Setting**

- **Overwrite:** Click checkbox to overwrite the storage device.
- **Stream Type:** You can select Stream1, Stream2, or Stream3.
 - * **Stream1:** H.264 or MPEG-4 data
 - * **Stream2:** MJPEG data
 - * **Stream3:** You can select VIDEO or IMAGE.
- **Pre-event:** Enter pre-event time value for storage device pre-recording.
- **Post-event:** Enter post-event time value for storage device post-recording.

- **Device Setting**

Select Device Type to be recorded in the drop-down list.

- **SD:** built-in SD card
- **CIFS:** A file format for a NAS device.
- **NFS:** A file format for a NAS device.

Note1: Common Internet File System (CIFS) is a remote file access protocol that forms the basis for Windows file sharing, network printing, and various other network services. CIFS requires a large number of request/response transactions and its performance degrades significantly over high-latency WAN links such as the Internet.

Note2: Network File System (NFS) is a network file system protocol, allowing a user on a client computer to access files over a network in a manner similar to how local storage is accessed. NFS, like many other protocols, builds on the Open Network Computing Remote Procedure Call (ONC RPC) system.

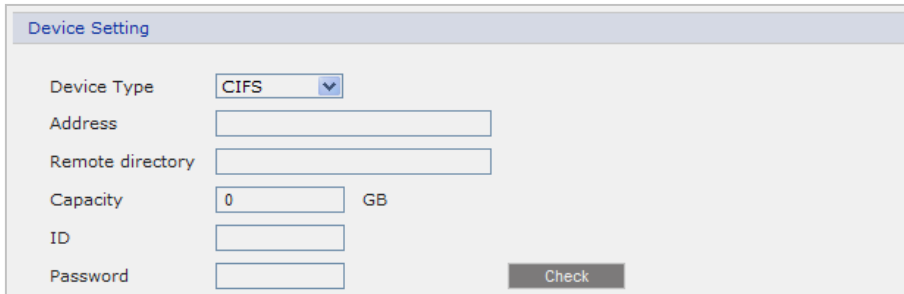

Device Setting

Device Type: CIFS

Address:

Remote directory:

Capacity: GB

ID:

Password:

Check

- * **Address:** Enter IP address for NAS device.
- * **Remote Directory:** Enter directory or folder location to be recorded in the NAS device.
- * **Capacity:** Enter the capacity of storage to be used. It must be less than the total storage capacity.
- * **IP/Password:** Enter ID and Password. The network camera will ask them whenever you access NAS device.
- * **Check:** Press the Check button to check the validity of Device Setting data.

- **Format**

Click the Format button to format SD card.

- **Device Information**

Show current SD card information.

3) Event Map

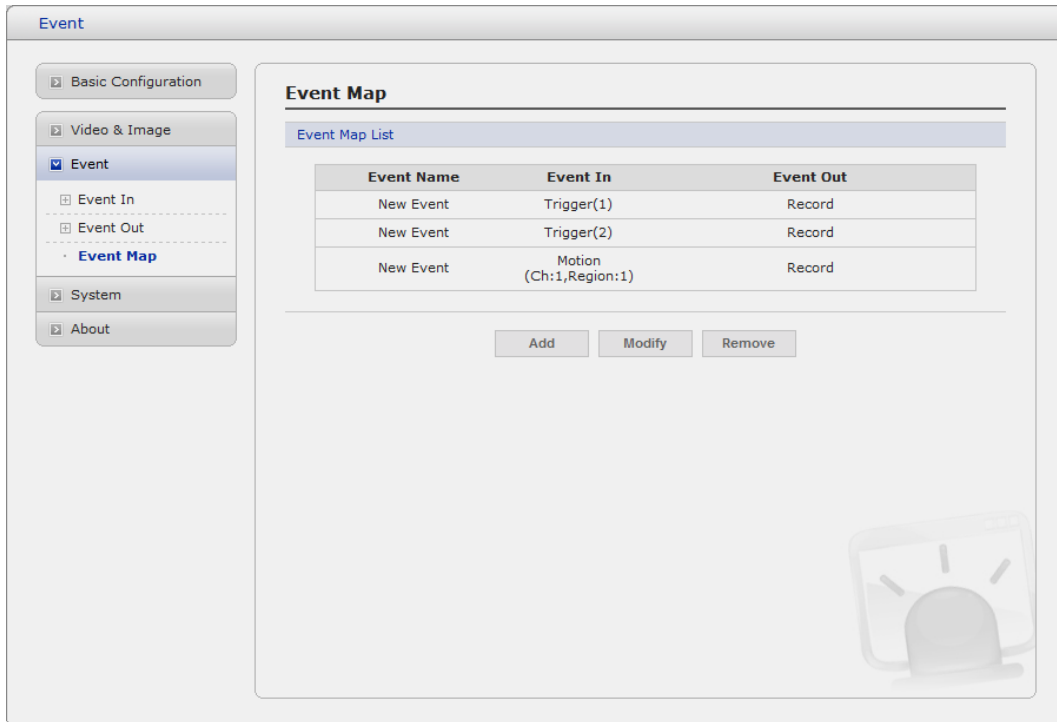

The event map allows you to change the settings and establish a schedule for each event trigger from the Network Camera. You can register the event map up to max. 15.

Click Add button to make a new event map and you can see a popup window as below.

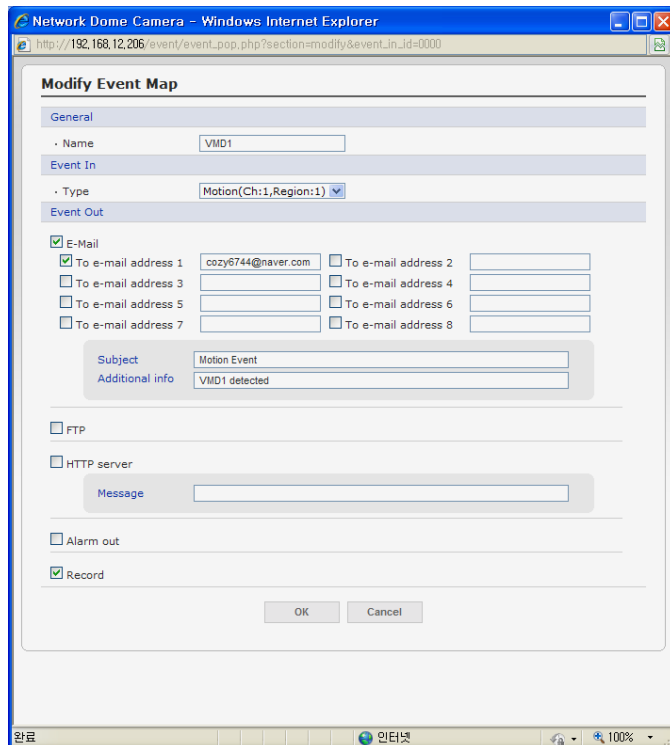

- **General**
Enter the name for a new event map.
- **Event In**
Select an event type in the drop down list.
- **Event Out**
 - **E-mail:** Select email addresses you want to send via email that an event has occurred.
 - **FTP:** Select checkbox beside FTP to record and saves images to an FTP server when an event has occurred.
 - **HTTP Server:** It sends notification messages to an HTTP server that listens for these. The destination server must first be configured on the Event In page. Enter a message you want to send.
 - **Record:** Select Record checkbox to record video stream when an event has occurred. The Record option must first be configured on the Event Out page.

3.5.4 System

1) Information

You can enter the system information. This page is very useful when you refer device information after installation.

- **Device Name Configuration**
Enter the device name.
- **Location Configuration**
Enter the location information. You can enter that by four.

2) Security

▼ Users

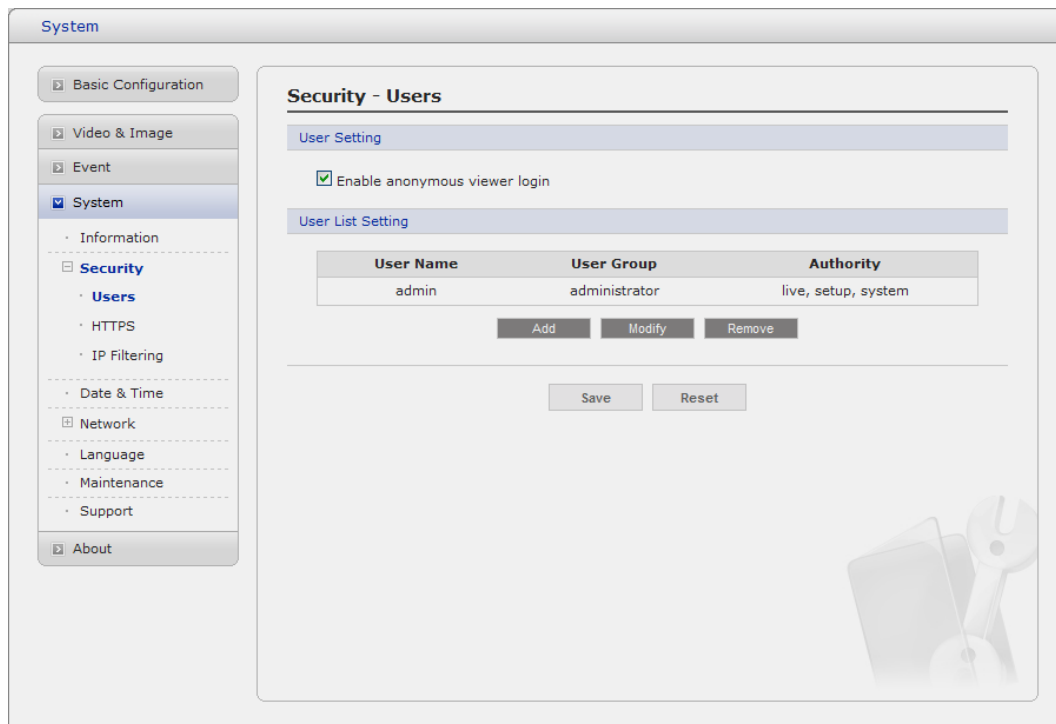

User access control is enabled by default, when the administrator sets the root password on first access. New users are authorized with user names and passwords, or the administrator can choose to allow anonymous viewer login to the Live View page, as described below:

- **User Setting**

Check the box to enable anonymous viewer login to the Network Camera without the user account. When using the user account, users have to try log-in at every access.

- **User List Setting**

This section shows a registered user account. Enter a user name and password to be added, and register them by pressing the Add button. You can see the pop-up window as below.

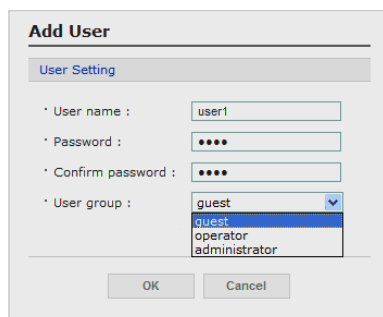

▼ HTTPS

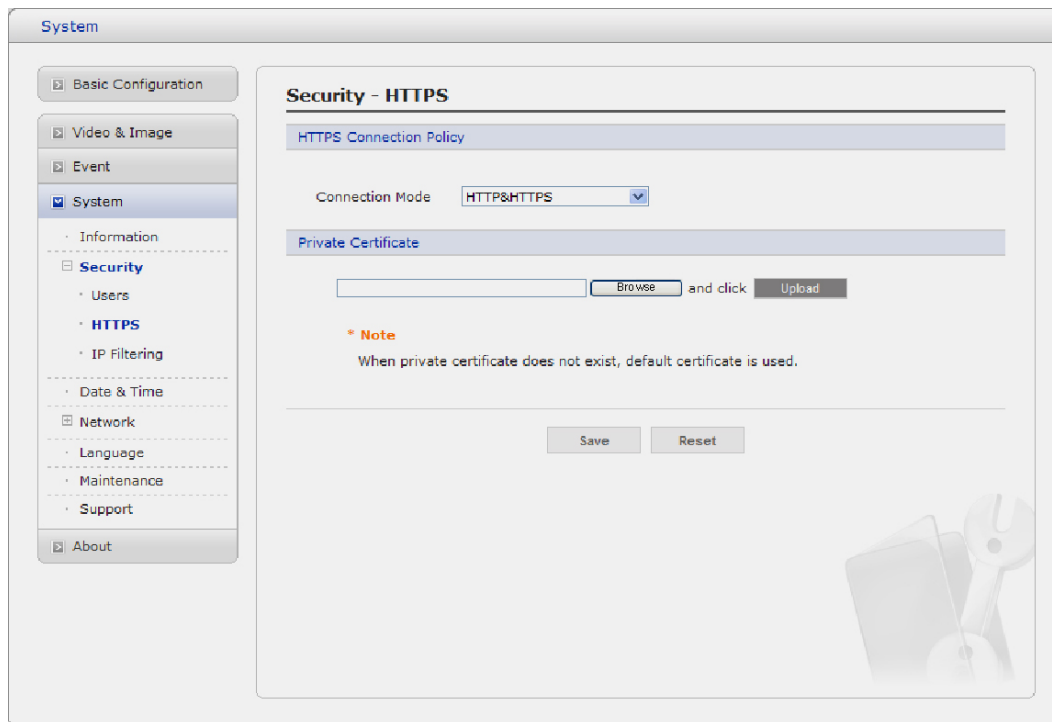

For greater security, the Network Camera can be configured to use HTTPS (Hypertext Transfer Protocol over SSL (Secure Socket Layer)). That is, all communication that would otherwise go via HTTP will instead go via an encrypted HTTPS connection.

- **HTTPS Connection Policy**

Choose the form of connection you wish to use from the drop-down list for the administrator, Operator and Viewer to enable HTTPS connection (set to HTTP by default).

- **HTTP**
- **HTTPS**
- **HTTP & HTTPS**

- **Upload Certificate**

To use HTTPS for communication with the Network Camera, An official certificate issued by a CA (Certificate Authority) must be uploaded from your PC. Provide the path to the certificate directly, or use the **Browse** button to locate it. Then click the **Upload** button.

Please refer to the home page of your preferred CA for information on where to send the request. For more information, please see the online help.

▼ IP Filtering

The screenshot shows a web-based configuration interface for a system. On the left is a navigation menu with categories: Basic Configuration, Video & Image, Event, System (selected), Information, Security (expanded), Users, HTTPS, IP Filtering (selected), Date & Time, Network, Language, Maintenance, Support, and About. The main content area is titled "Security - IP Filtering" and contains an "IP Filtering Setting" section. It features a checkbox for "Enable IP filtering" which is currently unchecked. Below this is a table with five rows, each representing a filter rule. The columns are "On/Off", "Priority", "Policy", "Start IP", and "End IP". All "On/Off" checkboxes are unchecked, and all "Policy" dropdowns are set to "ALLOW". The "Start IP" and "End IP" fields are all set to "0 . 0 . 0 . 0". At the bottom of the table are "Save" and "Reset" buttons. A faint watermark of a laptop and a wrench is visible in the bottom right corner of the interface.

On/Off	Priority	Policy	Start IP	End IP
<input type="checkbox"/>	1	ALLOW	0 . 0 . 0 . 0	0 . 0 . 0 . 0
<input type="checkbox"/>	2	ALLOW	0 . 0 . 0 . 0	0 . 0 . 0 . 0
<input type="checkbox"/>	3	ALLOW	0 . 0 . 0 . 0	0 . 0 . 0 . 0
<input type="checkbox"/>	4	ALLOW	0 . 0 . 0 . 0	0 . 0 . 0 . 0
<input type="checkbox"/>	5	ALLOW	0 . 0 . 0 . 0	0 . 0 . 0 . 0

Checking the **Enable IP address filtering** box enables the IP address filtering function. Up to 256 IP address entries may be specified (a single entry can contain multiple IP addresses). Click the **Add** button to add new filtered addresses.

When the IP address filter is enabled, addresses added to the list are set as allowed **or** denied addresses. All other IP addresses not in this list will then be allowed or denied access accordingly, that is, if the addresses in the list are allowed, then all others are denied access, and vice versa. See also the online help for more information.

Note that users from IP addresses that will be allowed must also be registered with the appropriate access rights (Guest, Operator or Administrator). This is done from Setup> System>Security>Users.

3) Date & Time

The screenshot shows a web-based configuration interface for a system. On the left is a navigation menu with categories: Basic Configuration, Video & Image, Event, System (selected), Information, Security, Date & Time (highlighted), Network, Language, Maintenance, Support, and About. The main content area is titled 'Date & Time' and contains several sections:

- Current Server Time:** Displays the current date (2011-04-08) and time (15:50:29).
- New Server Time:**
 - Time zone:** A dropdown menu is set to '(GMT+09:00) Seoul'. There is a checkbox for 'Automatically adjustment for daylight saving time changes' which is currently unchecked.
 - Time mode:** Three radio buttons are present:
 - Synchronize with computer time:** Selected. Shows Date: 2011-04-08 and Time: 15:50:36.
 - Synchronize with NTP server:** Unselected. Shows NTP server: time.nist.gov and NTP Interval: 12 [hour].
 - Set manually:** Unselected. Shows Date: 2011-04-08 and Time: 15:50:28.
- Date & Time Format:** Two dropdown menus are shown: 'Date Format' is set to 'YYYY-MM-DD' and 'Time Format' is set to '24 Hour'.

At the bottom of the configuration area are 'Save' and 'Reset' buttons.

- **Current Server Time**
It displays the current date and time (24h clock). The time can be displayed in 12h clock format in the overlay (see below).
- **New Server Time**
Select your time zone from the drop-down list. If you want the server clock to automatically adjust for daylight savings time, select "Automatically adjustment for daylight saving time changes".

From the Time Mode section, select the preferred method to use for setting the time:

- **Synchronize with computer time:** sets the time from the clock on your computer.
- **Synchronize with NTP Server:** the video encoder will obtain the time from an NTP server every 60 minutes.
- **Set manually:** this option allows you to manually set the time and date.

Note: Note that if using a host name for the NTP server, a DNS server must be configured under TCP/IP settings.

4) Network

The screenshot displays a web-based network configuration interface. On the left is a sidebar menu with categories: Basic Configuration, Video & Image, Event, System (selected), Information, Security, Date & Time, Network (expanded), Basic (selected), DDNS, RTP, UPnP, QoS, NAT Traversal, Zeroconf, Bonjour, Language, Maintenance, Support, and About. The main content area is titled 'Network - Basic' and contains several sections: 'IP Address Configuration' with radio buttons for DHCP and static IP (selected), and input fields for IP address (192.168.30.36), Subnet mask (255.255.255.0), and Default router (192.168.30.1); 'IPv6 Address Configuration' with an unchecked 'Enable IPv6' checkbox and a displayed IPv6 address (fe80::207:d8ff:fe10:1a15/64); 'DNS Configuration' with radio buttons for DHCP and static DNS (selected), and input fields for Domain name, Primary DNS server (168.126.63.1), and Secondary DNS server (0.0.0.0); 'Host Name Configuration' with a text field for Host Name (HDG-T322NSRA80007D8101A); 'Services' with input fields for HTTP port (80), HTTPS port (443), and RTSP port (554); and 'ARP/Ping setting' with a checked 'Enable ARP/Ping setting' checkbox. At the bottom right are 'Save' and 'Reset' buttons.

Setting in regard to network can be executed. Settings for IP, DNS, Host Name, Port, and ARP/Ping can be established, along with setting for DDNS, uPnP, QoS, Zeroconf, and Bonjour.

▼ Basic

- **IP Address Configuration:**
 - **Obtain IP address via DHCP:** Dynamic Host Configuration Protocol (DHCP) is a protocol that lets network administrators centrally manage and automate the assignment of IP addresses on a network. DHCP is enabled by default. Although a DHCP server is mostly used to set an IP address dynamically, it is also possible to use it to set a static, known IP address for a particular MAC address.
 - **Use the following IP address:** To use a static IP address for the Network Camera, check the radio button and then make the following settings:
 - * **IP address:** Specify a unique IP address for your Network Camera.
 - * **Subnet mask:** Specify the mask for the subnet the Network Camera is located on.
 - * **Default router:** Specify the IP address of the default router (gateway) used for connecting devices attached to different networks and network segments.
- **IPv6 Address Configuration**

Check this box to enable IPv6. Other settings for IPv6 are configured in the network router.
- **DNS Configuration**

DNS (Domain Name Service) provides the translation of host names to IP addresses on your network.

 - **Obtain DNS Server via DHCP:** Automatically use the DNS server settings provided by the DHCP server. Click the View button to see the current settings.
 - Use the following DNS server address to enter the desired DNS server by specifying the following:
 - * **Domain name:** enter the domain(s) to search for the host name used by the Network Camera. Multiple domains can be separated by semicolons (;). The host name is always the first part of a Fully Qualified Domain Name, for example, myserver is the host name in the Fully Qualified Domain Name [myserver.mycompany.com](#) where mycompany.com is the Domain name.
 - * **DNS servers:** enter the IP addresses of the primary and secondary DNS servers.
- **Host Name Configuration**
 - **Host Name** – enter the host name to be used as device information in the client software or SmartManager.
- **Services**
 - **HTTP port:** Enter a port to receive a service through the HTTP. Default Port Number is '80'.
 - **HTTPS port:** Enter a port to receive a service through the HTTPS. Default Port Number is '443'.
 - **RTSP port:** Enter a port to receive a service through the RTSP. Default Port Number is '554'.
- **ARP/Ping Setting**
 - Enable ARP/Ping setting of IP address - The IP address can be set using the ARP/Ping method, which associates the unit's MAC address with an IP address. Check this box to enable the service.
Leave disabled to prevent unintentional resetting of the IP address.

▼ DDNS

The screenshot shows a web interface for configuring DDNS. On the left is a navigation menu with categories like Basic Configuration, Video & Image, Event, System, Information, Security, Date & Time, Network, Basic, DDNS, RTP, UPnP, QoS, NAT Traversal, Zeroconf, Bonjour, Language, Maintenance, Support, and About. The main content area is titled 'Network - DDNS' and contains the following elements:

- Internet DDNS (Dynamic Domain Name Service)**
- Enable DDNS
- * Note**
Please remember you have to configure at least primary DNS server in DNS configuration settings to use Dynamic DNS.
- DDNS Server:
- Registered host:
- User name:
- Password:
- Confirm password:
- Maximum time interval:
- Register local network IP address
- Registered IP address :
- Buttons: Save, Reset

- **Internet DDNS(Dynamic Domain Name Service)**

When using the high-speed Internet with the telephone or cable network, users can operate the Network Camera even on the floating IP environment in which IPs are changed at every access. Users should receive an account and password by visiting a DDNS service like <http://www.dyndns.com/>, or <http://www.cctv-network.co.kr/>.

- **Enable DDNS:** Check to get DDNS service to be available.
 - * **DDNS Server:** Select the DDNS server.
 - * **Registered host:** Enter an address of the DDNS server.
 - * **Username:** Enter an ID to access to the DDNS server.
 - * **Password:** Enter a password to be used for accessing the DDNS server.
 - * **Confirm:** Enter a password again to confirm it.
 - * **Maximum time interval:** Set a time interval to synchronize with the DDNS server. Select an item in the interval drop-down list.
 - * **Register local network IP address:** Register a Network Video Server IP address to the DDNS server

▼ RTP

System

Basic Configuration

Video & Image

Event

System

- Information
- Security
- Date & Time
- Network**
 - Basic
 - DDNS
 - RTP**
 - UPnP
 - QoS
 - NAT Traversal
 - Zeroconf
 - Bonjour
- Language
- Maintenance
- Support

About

Network - RTP

Port Range

Start port: [30000... 39920; only even values are available]

End port:

Multicast (Stream 1)

Enable multicast

- Multicast destination IP: [224.0.0.0... 239.255.255.255]
- RTP port: [1024... 65530; only even values are available]
- RTP TTL: [1... 255]

Enable always multicast

Multicast (Stream 2)

Enable multicast

- Multicast destination IP: [224.0.0.0... 239.255.255.255]
- RTP port: [1024... 65530; only even values are available]
- RTP TTL: [1... 255]

Enable always multicast

Multicast (Stream 3)

Enable multicast

- Multicast destination IP: [224.0.0.0... 239.255.255.255]
- RTP port: [1024... 65530; only even values are available]
- RTP TTL: [1... 255]

Enable always multicast

Save Reset

Have a setting for sending and receiving an audio or video on a real-time basis. These settings are the IP address, port number, and Time-To-Live value to use for the media stream(s) in multicast H.264 format. Only certain IP addresses and port numbers should be used for multicast streams. For more information, please see the online help.

- **Port Range**

- **Start port:** Enter a value between 1024 and 65532

- **Multicast(Stream1/Stream2/Stream3)**

This function is for sending Video and Audio to Multicast group.

- **Enable Multicast:** Check the box to enable multicast operation.
- **Multicast destination IP:** Enter an IP between 224.0.0.0 and 239.255.255.255. Although it is empty, an IP will be entered automatically.
- **RTP port:** Enter a value between 1024 and 65532.
- **RTP TTL:** Enter a value between 1 and 255. If a network status is smooth, enter a lower value. On the other hand, if a network status is poor, enter a higher value. When there are many Network Cameras or users, a higher value may cause a heavy load to the network. For a detailed setting, please consult with a network manager.

▼ UPnP

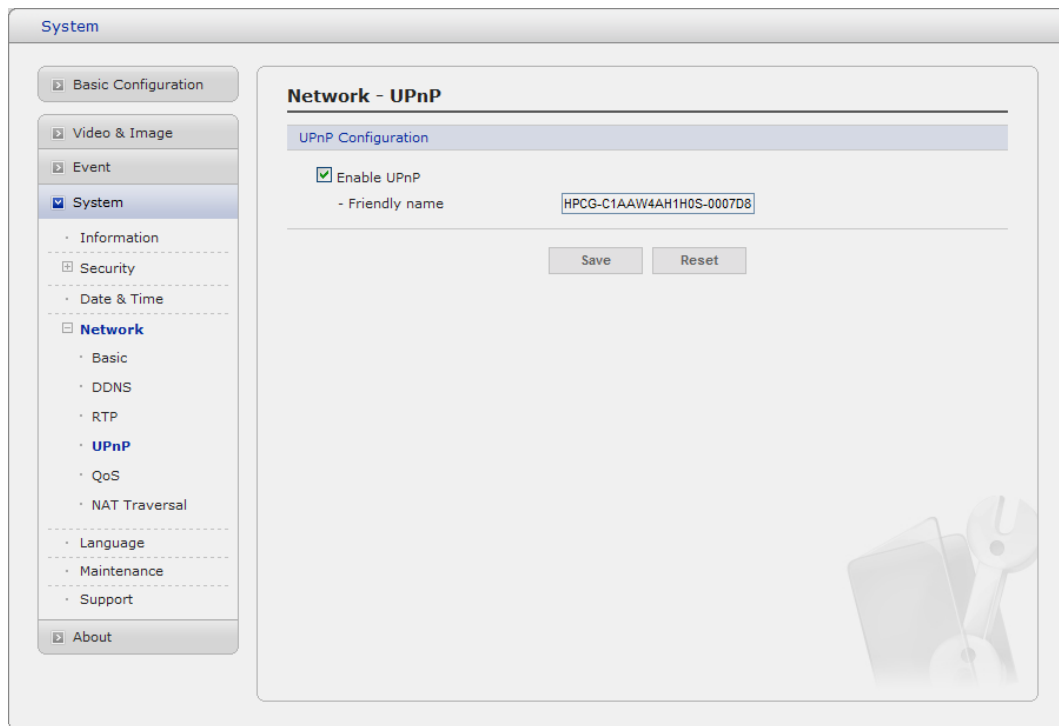

The Network Camera includes support for UPnP™. UPnP™ is enabled by default, and the Network Camera then is automatically detected by operating systems and clients that support this protocol.

Note: UPnP™ must be installed on your workstation if running Windows XP. To do this, open the Control Panel from the Start Menu and select Add/Remove Programs. Select Add/Remove Windows Components and open the Networking Services section. Click Details and then select UPnP™ as the service to add.

▼ QoS

Quality of Service (QoS) provides the means to guarantee a certain level of a specified resource to selected traffic on a network. Quality can be defined as a maintained level of bandwidth, low latency, and no packet losses.

The main benefits of a QoS-aware network are:

- The ability to prioritize traffic and thus allow critical flows to be served before flows with lesser priority.
- Greater reliability in the network, thanks to the control of the amount of bandwidth an application may use, and thus control over bandwidth races between applications.

The screenshot shows a web interface for configuring QoS settings. On the left is a navigation menu with categories like Basic Configuration, Video & Image, Event, System, Information, Security, Date & Time, Network, Basic, DDNS, RTP, UPnP, QoS, NAT Traversal, Zeroconf, Bonjour, Language, Maintenance, Support, and About. The main content area is titled 'Network - QoS' and contains two sections: 'DSCP Setting' and 'Automatic Traffic Control'. Under 'DSCP Setting', there are three rows: 'Live stream DSCP' with a value of 0 and a range of [0... 63], 'Event/Alarm DSCP' with a value of 0 and a range of [0... 63], and 'Management DSCP' with a value of 0 and a range of [0... 63]. The 'Automatic Traffic Control' section has an unchecked checkbox for 'Enable automatic traffic control'. Below it, the 'Maximum bandwidth' radio button is selected, with a value of 1 in a text box, a unit dropdown set to 'Mbit/s', and a 'Priority' dropdown set to 'Framerate'. The 'Automatic framerate control' radio button is unselected. At the bottom of the section are 'Save' and 'Reset' buttons. A faint watermark of a laptop and a wrench is visible in the bottom right corner of the main content area.

- **DSCP Settings**

For each type of network traffic supported by your network video product, enter a DSCP (Differentiated Services Code Point) value. This value is used to mark the traffic's IP header. When the marked traffic reaches a network router or switch, the DSCP value in the IP header tell the router or switch which type of treatment to apply to this type of traffic, for example, how much bandwidth to reserve for it. Note that DSCP values can be entered in decimal or hex form, but saved values are always shown in decimal.

The following types of traffic are marked:

- **Live Stream DSCP:**
- **Event/Alarm DSCP:**
- **Management DSCP:**

- **Auto Traffic Control**

Set a limitation on user network resources by designating the maximum bandwidth.

- Maximum bandwidth - In case of sharing other network programs or equipment, it is possible to set a limitation on the maximum bandwidth in the unit of Mbit/s or kbit/s.
- Auto frame rate - Selected if not influenced by a network-related program or equipment without a limitation on the network bandwidth.

▼ **NAT Traversal**

A broadband router allows devices on a private network (LAN) to share a single connection to the Internet. This is done by forwarding network traffic from the private network to the “outside”, that is, the Internet. Security on the private network (LAN) is increased since most broadband routers are pre-configured to stop attempts to access the private network (LAN) from the public network/Internet.

Use **NAT traversal** when your network cameras are located on an intranet (LAN) and you wish to make it available from the other (WAN) side of a NAT router. With NAT traversal properly configured, all HTTP traffic to an external HTTP port in the NAT router is forwarded to the network camera.

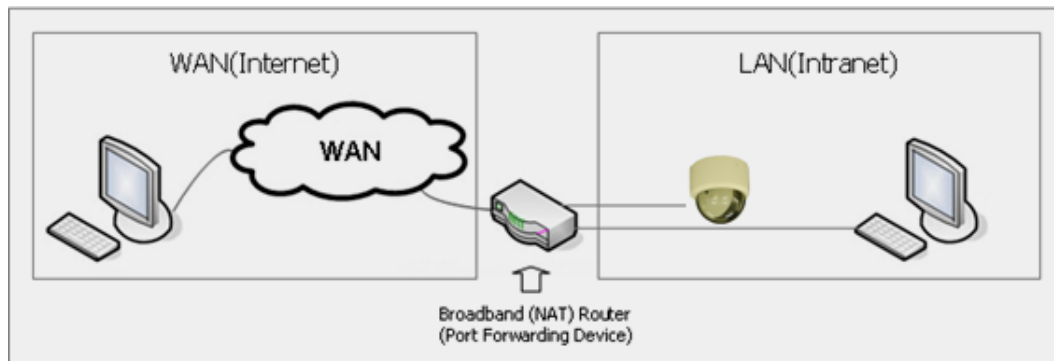

Notes:

- For NAT traversal to work, this must be supported by the broadband router.
- The broadband router has many different names: “NAT router”, “Network router”, “Internet Gateway”, “Broadband sharing device” or “Home firewall” but the essential purpose of the device is the same.

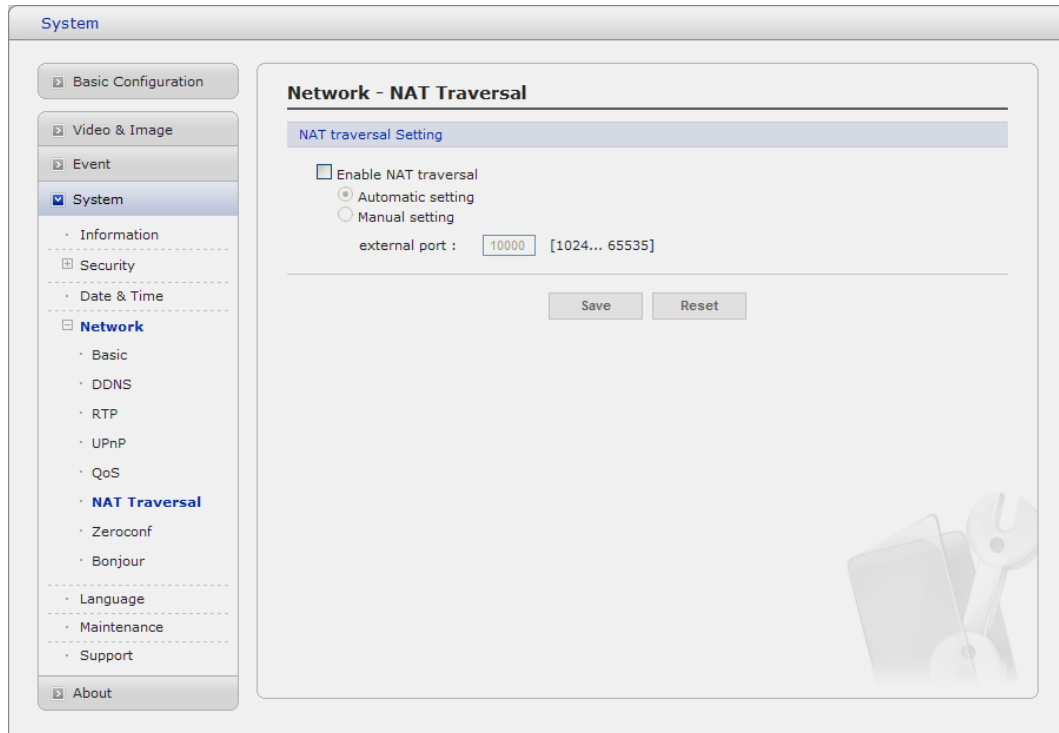

- **NAT traversal Settings**

- **Enable** - when enabled, the network transmitters attempt to configure port mapping in a NAT router on your network, using UPnP™. Note that UPnP™ must be enabled in the Network Camera (see System>Network>UPnP).
- * **automatic setting:** The Network Camera automatically search for NAT routers on your network.
- * **manual setting:** Select this option to manually select a NAT router and enter the external port number for the router in the field provided.

Notes:

- If you attempt to manually enter a port that is already in use, an alert message will be displayed.
- When the port is selected automatically it is displayed in this field. To change this enter a new port number and click Save.

▼ Zeroconf

Zeroconf allows the network camera to create and assign IP address for network cameras and connect to a network automatically.

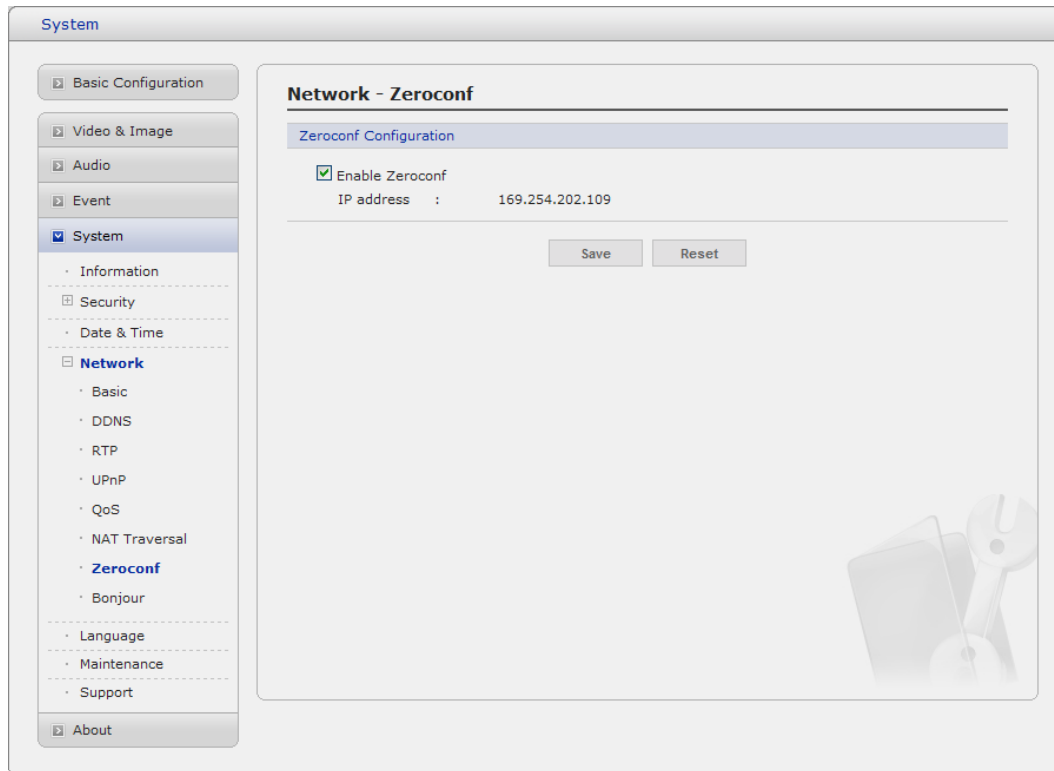

Zero configuration networking (zeroconf), is a set of techniques that automatically creates a usable Internet Protocol (IP) network without manual operator intervention or special configuration servers.

Zero configuration networking allows devices such as computers and printers to connect to a network automatically. Without zeroconf, a network administrator must set up services, such as Dynamic Host Configuration Protocol (DHCP) and Domain Name System (DNS), or configure each computer's network settings manually, which may be difficult and time-consuming.

Zeroconf is built on three core technologies:

- Assignment of numeric network addresses for networked devices (link-local address auto configuration)
- Automatic resolution and distribution of computer hostnames (multicast DNS)
- Automatic location of network services, such as printing devices through DNS service discovery.

▼ Bonjour

The network camera includes support for Bonjour. When enabled, the network camera is automatically detected by operating systems and clients that support this protocol.

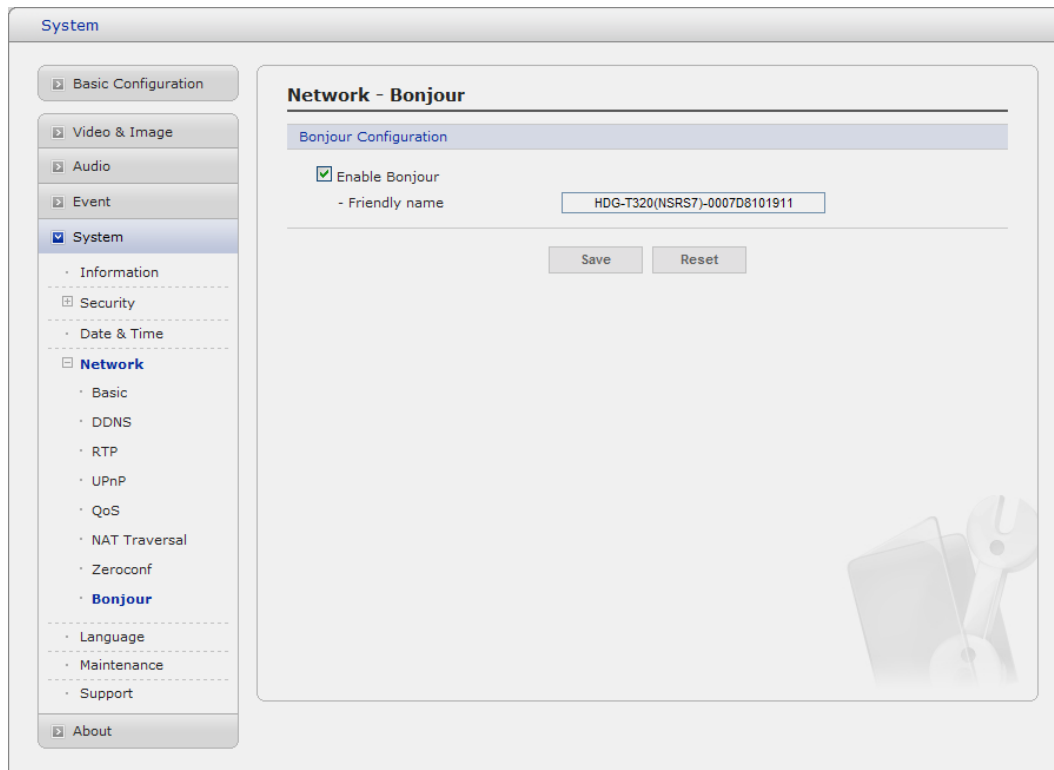

Note: Bonjour - Also known as zero-configuration networking, Bonjour enables devices to automatically discover each other on a network, without having to enter IP addresses or configure DNS servers. Bonjour is a trademark of Apple Computer, Inc.

5) Language

It will be able to select a user language. The type of language it will be able to select is the English, the French, the German, the Spanish and the Italian.

6) Maintenance

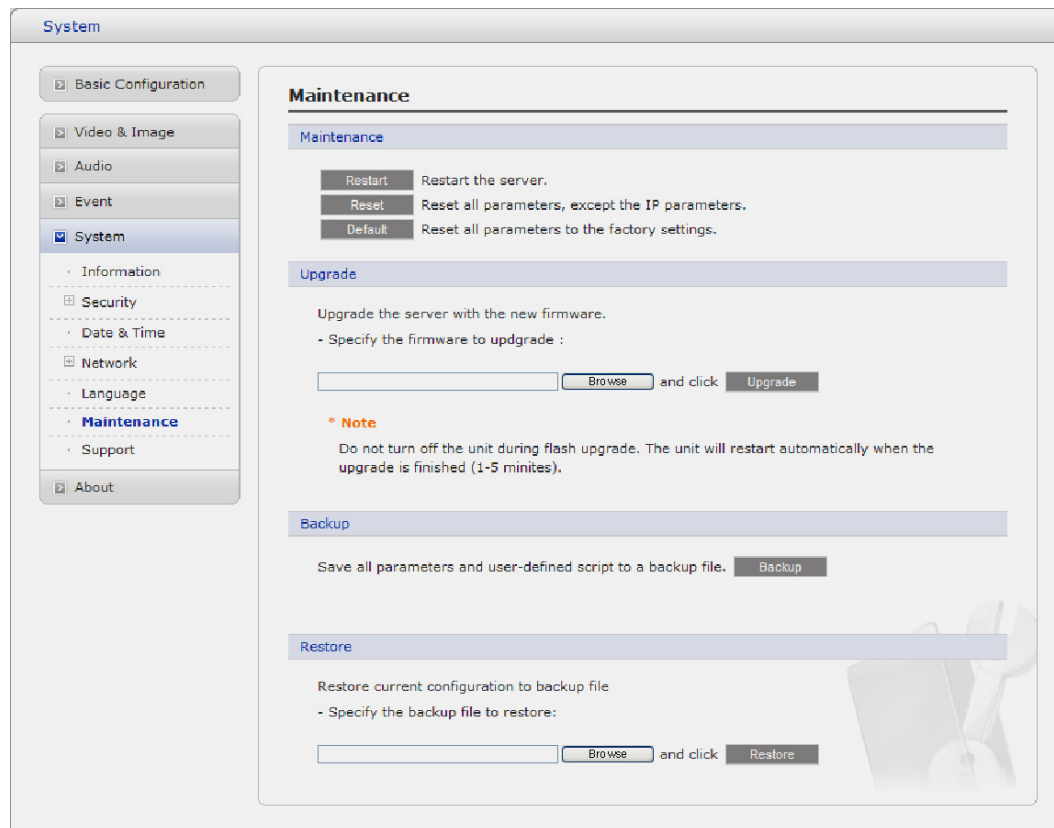

- **Maintenance Server**

- **Restart:** The unit is restarted without changing any of the settings. Use this method if the unit is not behaving as expected.
- **Restore:** The unit is restarted and most current settings are reset to factory default values. The settings that are not affected are:
 - * the boot protocol (DHCP or static)
 - * the static IP address
 - * the default router
 - * the subnet mask
 - * the system time
- **Default:** The default button should be used with caution. Pressing this will return all of the Network Camera's settings to the factory default values (including the IP address).

- **Update Server**

Carry out the upgrade by importing an upgrade file and pressing the Upgrade button. During the upgrade, do not turn off the power of the Network Camera. And try an access again after waiting five minutes or longer.

- **Backup**

Save a setting value that users enter to the Network Camera, to a user PC.

- **Restore**

Import and apply a setting value saved to a user PC.

Note: Backup and Restore can only be used on the same unit running the same firmware. This feature is not intended for multi-configurations or for firmware upgrades.

7) Support

The support page provides valuable information on troubleshooting and contact information, should you require technical assistance.

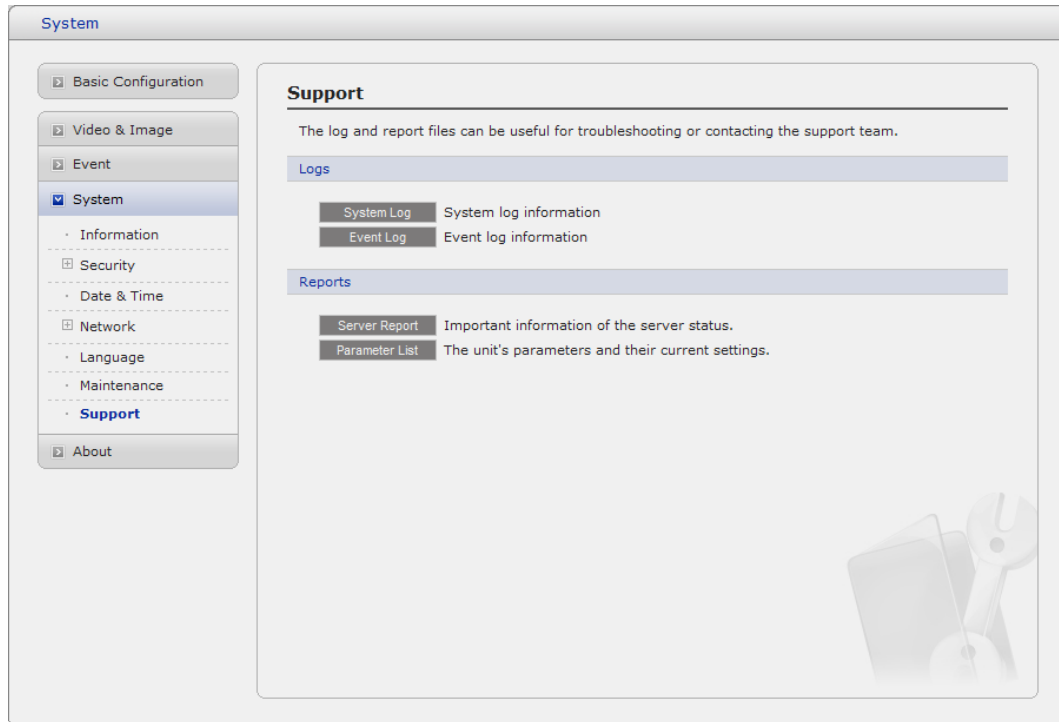

- **Logs**
The network Camera support system log information. Click the System Log button to get the log data.
- **Update Server**
 - **Server Report:** Click the Server Report button to get the important information about the server's status and should always be included when requesting support.
 - **Parameter List:** Click the Parameter List button to see the unit's parameters and their current settings.

3.5.5 About

The following website will provide the support information for the Network Camera information and operation.

3.6 Playback

The Playback window contains a list of recordings made to the memory card. It shows each recording's start time, length, the event type used to start the recording, calendar and time slice bar indicates if the recording is existed or not.

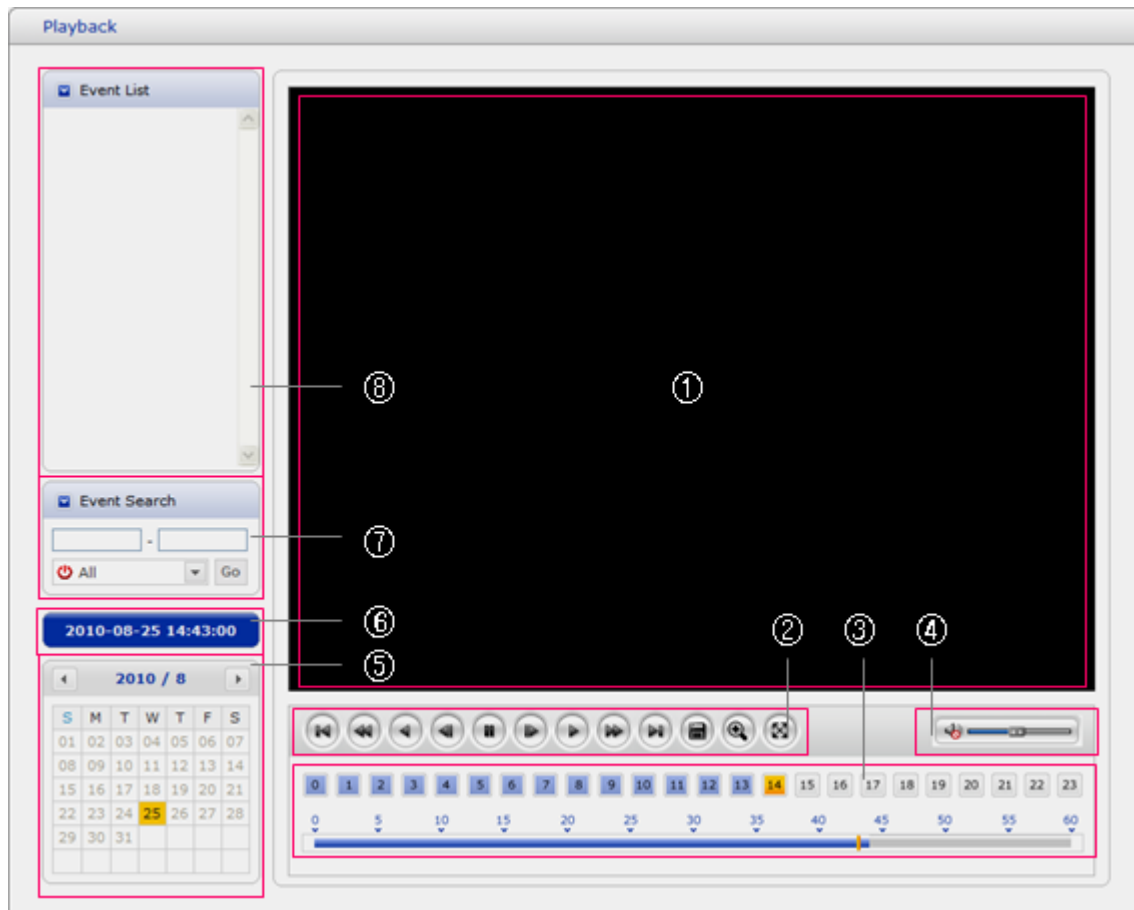









The description of playback window follows.





(1) Video Screen

You can see the video screen when playing the video clip in the Micro SD memory

(2) Playback Buttons

To view a recording data in the SD local storage, select it from the list and click the Playback buttons.

-  Go to the first: go to the beginning of the video clip.
-  Fast backward play:
-  Backward play: play backward of the video clip.
-  Step backward play: go back one frame of the video clip.
-  Pause: pause playback of the video clip.
-  Step forward play: go forward one frame of the video clip.
-  Forward Play: play forward the video clip.
-  Fast forward play: play fast forward of the video clip.

-  Step forward play: go forward one frame of the video clip.
-  Clip copy: copy the video clip.
-  Zoom In: zoom in the video clip
-  Full Screen: display full screen of the video.

(3) Time Chart

Display an hour-based search screen for the chosen date. If there is recording data, a blue section will be displayed on a 24-hour basis.

(4) Speaker Control Bar

Use this scale to control the volume of the speakers.

(5) Search Calendar

Search results from the SD local storage in the network camera connected are displayed monthly. If there is a recorded data for a particular date, a blue square on the date will be displayed.

(6) Play Time

Displays time of the video playing.

(7) Event Search Window

Select a search option in the drop-down list and click GO button. You can also enter the time period for searching. If you click Start Date or End Date zone, displays Search Calendar.

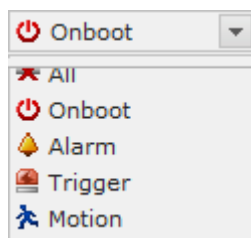

(8) Event List Window

Event List displays the event(s) that were recorded in the SD local storage. Select a list and click the play button. The video clip will be played.

3.7 Help

The Help information window will be provided as a popup window so that users can open and read it without a need for log-in. It will offer a description on setting and Help page by which users can manipulate the Network Camera without a reference to the manual.

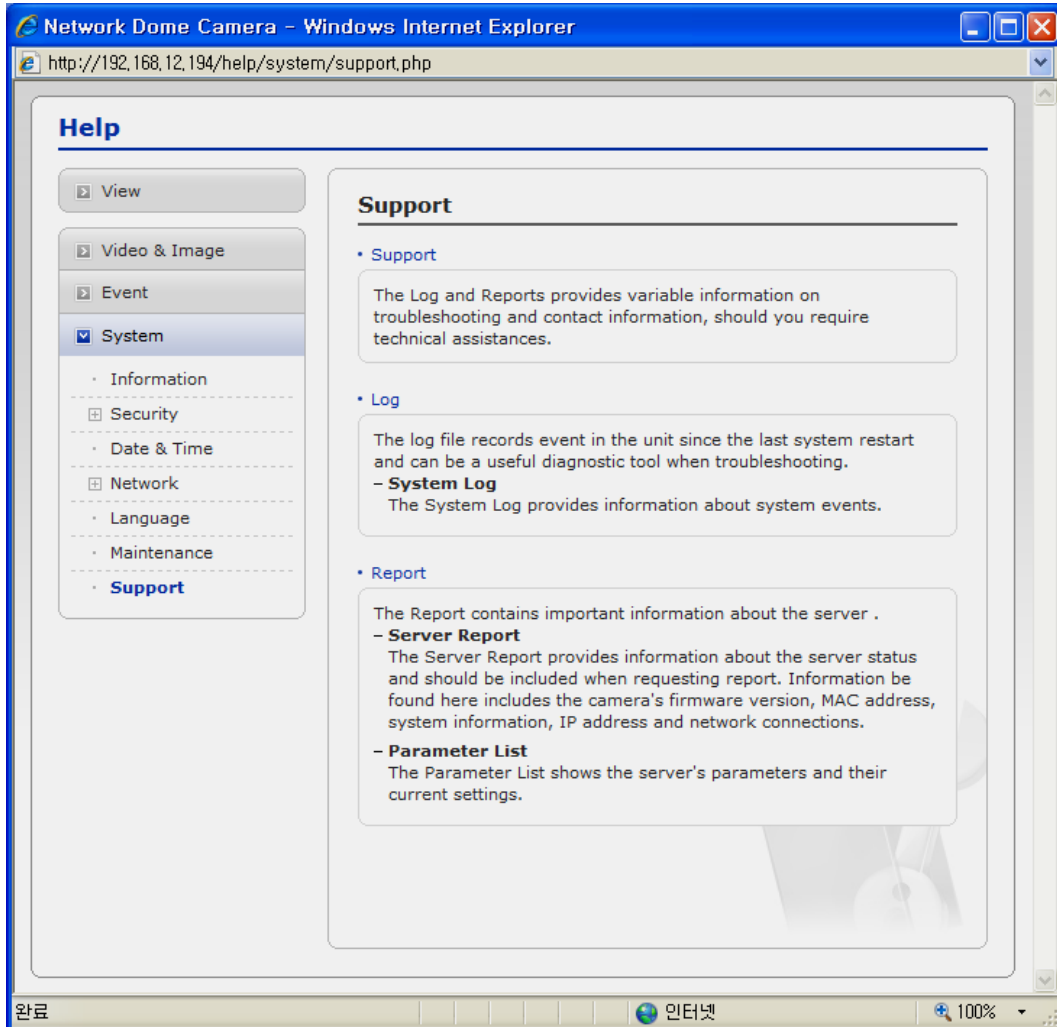

3.8 Resetting to the factory default settings

To reset the Network Camera to the original factory settings, go to the Setup>System> Maintenance web page (described in "3.6.6 System > Maintenance") or use the control button on the network camera, as described below:

- **Using the Reset Button**

Follow the instructions below to reset the Network Camera to the factory default settings using the Reset Button.

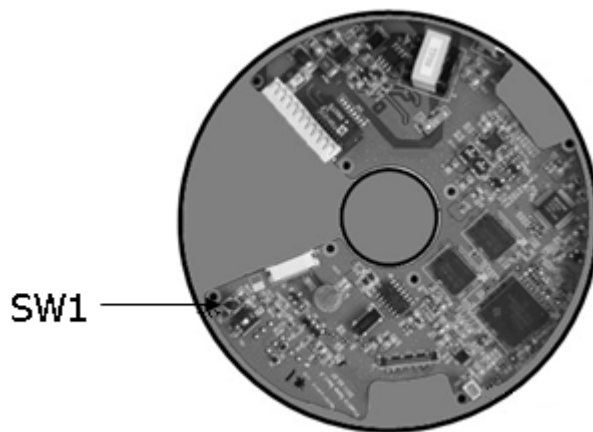

1. Switch off the Network Camera by disconnecting the power adapter.
2. Open the lens cover.
3. Press and hold the Control Button (SW1) on the board with your finger while reconnecting the power.
4. Keep the Control button (SW1) pressed during about 2 seconds.
5. Release the Control Button (SW1).
6. The network camera resets to factory defaults and restarts after completing the factory reset.
7. Close the lens cover.

CAUTION: When performing a Factory Reset, you will lose any settings you have saved.

4. Appendix

4.1 Troubleshooting

Troubleshooting if problems occur, verify the installation of the Network Camera with the instructions in this manual and with other operating equipment. Isolate the problem to the specific piece of equipment in the system and refer to the equipment manual for further information.

Problems/Symptoms	Possible Causes or Corrective Actions
The camera cannot be accessed by some clients.	If using a proxy server, try disabling the proxy setting in your browser. Check all cabling and connectors.
The camera works locally, but not externally.	Check if there are firewall settings that need to be adjusted. Check if there are router settings that need to be configured.
Poor or intermittent network connection.	If using a network switch, check that the port on that device uses the same setting for the network connection type (speed/duplex).
The camera cannot be accessed via a host name.	Check that the host name and DNS server settings are correct.
Not possible to log in.	When HTTPS is enabled, ensure that the correct protocol (HTTP or HTTPS) is used. When attempting to log in, you may need to manually type in http or https in the browser's address bar.
No image using Refresh and/or slow updating of images.	If images are very complex, try limiting the number of clients accessing the camera.
Images only shown in black & white.	Check the Video & Image setting.
Blurred images.	Refocus the camera.
Poor image quality.	Increased lighting can often improve image quality. Check that there is sufficient lighting at the monitored location. Check all image and lighting settings.
Rolling dark bands or flickering in image.	Try adjusting the Exposure Control setting under AE and AWB part.
H.264 not displayed in the client.	Check that the correct network interface is selected in the Video & Image/Stream.
Multicast H.264 not displayed in the client.	Check with your network administrator that the multicast addresses used by the camera are valid for your network. Check that the Enable multicast checkbox are enabled in the System/Network/RTP tab. Checks with your network administrator to see if there is a firewall preventing viewing.
Multicast H.264 only accessible by local clients.	Check if your router supports multicasting, or if the router settings between the client and the server need to be configured. The TTL value may need to be increased.
Color saturation is different in H.264 and Motion JPEG.	Modify the settings for your graphics adapter. Please see the adapter's documentation for more information.
Video cannot be recorded.	Check that the SD Card is inserted properly. Check that the SD Card is formatted properly.

4.2 Alarm Connection

The following connection diagram gives an example of how to connect a network camera.

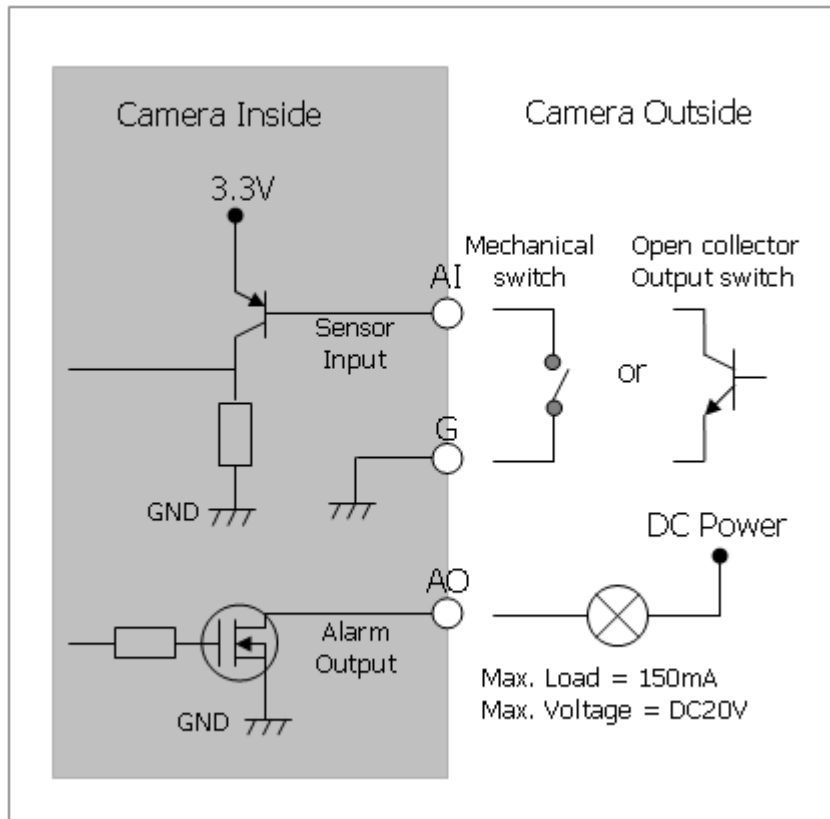

4.3 Preventive Maintenance

Preventive maintenance allows detection and correction of minor that faults before they become serious and cause equipment failure.

Every three-month, perform the following maintenance.

1. Inspect all connection cables for deterioration or other damage.
2. Clean components with a clean damp cloth.
3. Verify that all the mounting hardware is secure.

4.4 Product Specification

Main Item		Specification
C A M E R A	Image sensor	1/2.7" Progressive scan RGB CMOS
	Active Array	1280(H) x 1024(V)
	Lens	Varifocal 3.0mm ~ 9.0mm, F1.2, DC IRIS
	Angle of View	3.0mm – 93°(H) / 9.0mm – 31.7°(H)
	Camera Angle Adjustment	Pan: 360° Tilt: 180° Rotation: 360°
	Min. illumination	Color: 0.9Lux, B/W: 0.2Lux(F1.2, 50IRE)
	Shutter Speed	1/20,000 ~ 1/30
N E T W O R K	Video Compression	Motion JPEG MPEG-4 Part2 H.264 (MPEG-4 Part 10) Profiles: H.264 MP and BP, MPEG-4 ASP and SP
	Video Resolutions	HDG-T302: 320x240 ~ 1280x720 HDG-T312: 320x240 ~ 1280x1024 HDG-T322: 320x240 ~ 1920x1080
	Frame Rate	30fps @ all resolutions
	Video Streaming	Simultaneously H.264(or MPEG-4) and MJPEG Controllable Frame Rate and Bandwidth VBR/CBR H.264 and MPEG-4
	Protocol	TCP/IP, UDP, IPv4/v6, HTTP, HTTPS, QoS, FTP, SNMP, uPnP, RTP, RTSP, RTCP, DHCP, ARP, Zeroconf, Bonjour
	Security	Multi-user authority, HTTPS, IP Filtering, Privacy Zone
	Max. Connection	10
	API Programming Interface	API Supported, Open Platform Compatible: ONVIF
	Alarm Triggers	Motion Detection, External Input, Manual Trigger
	Alarm Events	File upload via FTP and HTTP Notification via E-mail, HTTP and TCP External Output activation
	Video Buffering	Pre and Post Alarm
	Motion Detection	Yes, max. 8 programmable zone
	Network Time Synchronization	Yes
	SD Recording	Yes, Continuous/Schedule/Event
	Software Reset	Yes
	Factory Reset	Yes, Button/Web browser
	Auto Recovery	Yes
Installation Tool	Yes, SmartManager	
Upgrade	Yes, Web browser, SmartManager	
G E N E R A L	Alarm Input	Terminal, 1 TTL input
	Alarm Output	Terminal, 1 open collector
	Ethernet	RJ-45 10BASE-T/100BASE-TX
	Operating Temperature	0°C ~ 50°C
	Operation Humidity	0~90% (non-condensing)
	Power Consumption	DC12V/PoE 330mA(4.0W) Power over Ethernet IEEE 802.3af Class0
	External Dimension (Φ x V)	118.4 x 105 [Bubble Diameter Φ]
	Unit Weight	305g
	Approval	FCC, CE

System Requirement for Web Browser

Operating System: Microsoft Windows 98, Microsoft Windows ME, Microsoft Windows 2000, Microsoft Windows XP, or Microsoft Windows Vista

CPU: Over Pentium IV 2.4Ghz, 512MB RAM, 10GB free disk or higher

VGA: AGP, Video RAM 32MB or higher (1024x768, 24bpp or higher)



**HD Plastic
DOME CAMERA**

