

INSTRUCTION MANUAL

20x Full-HD Mini-PTZ HD-TVI & AHD CAMERA



Please read this manual thoroughly before use and keep it handy for future reference.

WARNING

TO REDUCE THE RISK OF FIRE OR ELECTRIC SHOCK, DO NOT EXPOSE THIS PRODUCT TO RAIN OR MOISTURE. DO NOT INSERT ANY METALLIC OBJECTS THROUGH THE VENTILATION GRILLS OR OTHER OPENINGS ON THE EQUIPMENT.

CAUTION

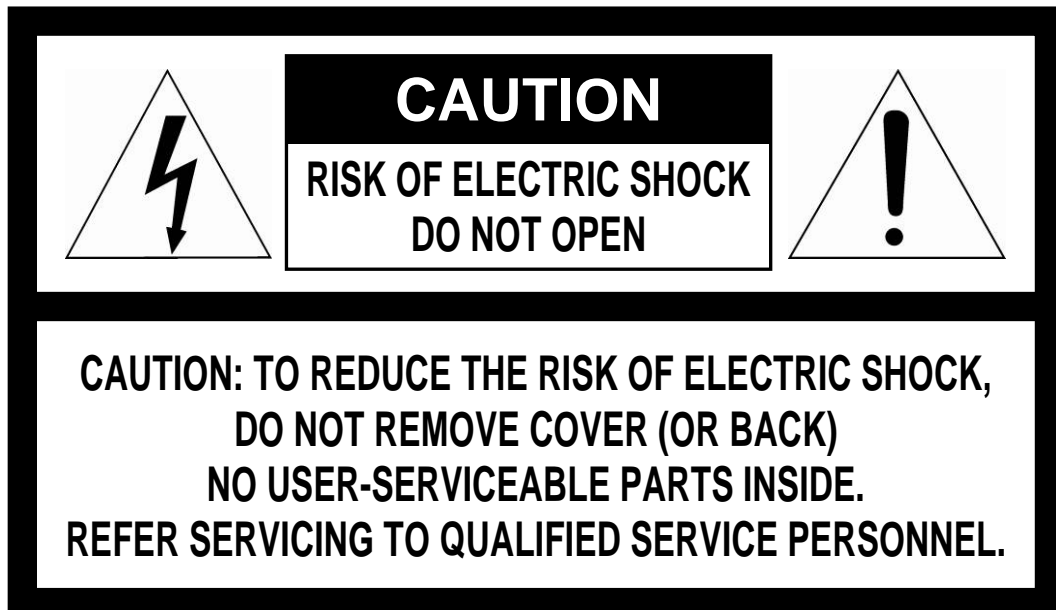

EXPLANATION OF GRAPHICAL SYMBOLS

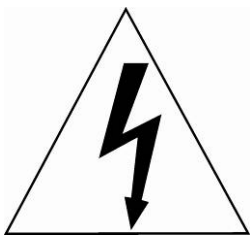

The lightning flash with arrowhead symbol, within an equilateral triangle, is intended to alert the user to the presence of uninsulated “dangerous voltage” within the product’s enclosure that may be of sufficient magnitude to constitute a risk of electric shock to persons.



The exclamation point within an equilateral triangle is intended to alert the user to the presence of important operating and maintenance (servicing) instructions in the literature accompanying the appliance.

FCC COMPLIANCE STATEMENT

This device complies with Part 15 of the FCC Rules. Operation is subject to the following two conditions: (1) this device may not cause harmful interference, and (2) this device must accept any interference received, including interference that may cause undesired operation.

FCC INFORMATION: This equipment has been tested and found to comply with the limits for a Class A digital device, pursuant to Part 15 of the FCC Rules. These limits are designed to provide reasonable protection against harmful interference when the equipment is operated in a commercial environment. This equipment generates, uses, and can radiate radio frequency energy and, if not installed and used in accordance with the instruction manual, may cause harmful interference to radio communications. Operation of this equipment in a residential area is likely to cause harmful interference in which case the user will be required to correct the interference at his own expense.

CAUTION: Changes or modifications not expressly approved by the party responsible for compliance could void the user's authority to operate the equipment.

This Class A digital apparatus complies with Canadian ICES-003.

Cet appareil numérique de la classe A est conforme à la norme NMB-003 du Canada.

CE COMPLIANCE STATEMENT

WARNING

This is a Class A product. In a domestic environment this product may cause radio interference in which case the user may be required to take adequate measures.

IMPORTANT SAFETY INSTRUCTIONS

1. Read these instructions.
2. Keep these instructions.
3. Heed all warnings.
4. Follow all instructions.
5. Do not use this apparatus near water.
6. Clean only with dry cloth.
7. Do not block any ventilation openings. Install in accordance with the manufacturer's instructions.
8. Do not install near any heat sources such as radiators, heat registers, stoves, or other apparatus (including amplifiers) that produce heat.
9. Do not defeat the safety purpose of the polarized or grounding-type plug. A polarized plug has two blades with one wider than the other. A grounding type plug has two blades and a third grounding prong. The wide blade or the third prong is provided for your safety. If the provided plug does not fit into your outlet, consult an electrician for replacement of the obsolete outlet.
10. Protect the power cord from being walked on or pinched particularly at plugs, convenience receptacles, and the point where they exit from the apparatus.
11. Only use attachments/accessories specified by the manufacturer.
12. Use only with the cart, stand, tripod, bracket, or table specified by the manufacturer, or sold with the apparatus. When a cart is used, use caution when moving the cart/apparatus combination to avoid injury from tip-over.
13. Unplug this apparatus during lightning storms or when unused for long periods of time.
14. Refer all servicing to qualified service personnel. Servicing is required when the apparatus has been damaged in any way, such as power-supply cord or plug is damaged, liquid has been spilled or objects have fallen into the apparatus, the apparatus has been exposed to rain or moisture, does not operate normally, or has been dropped.
15. **CAUTION – THESE SERVICING INSTRUCTIONS ARE FOR USE BY QUALIFIED SERVICE PERSONNEL ONLY. TO REDUCE THE RISK OF ELECTRIC SHOCK DO NOT PERFORM ANY SERVICING OTHER THAN THAT CONTAINED IN THE OPERATING INSTRUCTIONS UNLESS YOU ARE QUALIFIED TO DO SO.**
16. **Use satisfy clause 2.5 of IEC60950-1/UL60950-1 or Certified/Listed Class 2 power source only.**



Table of Contents

Chapter 1 — Introduction	6
1.1 Features	6
Chapter 2 — Installation and Configuration	7
2.1 Package Contents	7
2.2 Installation.....	8
2.2.1 Locking Dome Camera.....	8
2.2.2 Heater Kit Installation (Optional).....	10
2.3 Basic Configuration of Dome Camera System.....	11
2.4 Setting Dome Camera Address (ID).....	12
2.5 Setting Dome Camera Video Type & Coaxitron Protocol	12
2.6 Connections.....	13
2.7 Getting Started.....	14
Chapter 3 — Program and Operation	15
3.1 Dome Camera Selection	15
3.2 Accessing the On-Screen Menu Utility.....	15
3.3 How to control the On-Screen Menu Utility	15
3.4 Auto Scan (Shortcut: SCAN).....	16
3.5 Preset (Shortcut: PRST)	18
3.6 Shortcut of Preset Program	20
3.7 Tour (Shortcut: TOUR).....	20
3.8 Pattern (Shortcut: PTRN).....	22
3.9 Privacy Zone	23
3.10 Camera Menu.....	24
3.11 Dome Communication	27
3.12 Alarm	28
3.13 Dome Setup	29
Appendix A — Specifications	36
Appendix B — Troubleshooting	38

Chapter 1 — Introduction

1.1 Features

The dome camera and the keyboard controller make up the building blocks for any surveillance/security system. Using multiple keyboard controllers and multiple dome cameras, no place is too large for monitoring. Extensible and flexible architecture facilitates remote control functions for a variety of external switching devices such as multiplexers and DVRs.

- Built-in optical power zoom camera with True Night Shot function
- 240 Preset positions with the individual camera AE setup
- 8 Tours consist of Presets, Patterns, Auto Scans and other Tours can be programmed with over 300 functions and preset locations. While moving, each Preset scan can be watched in smooth **Vector Scan** mode.
- 16 Auto Scans with the normal, the vector, and the **random** mode and the endless Auto-Pan with 13 speed steps
 - 8 Patterns (up to 500 seconds) and 8 Privacy Zones
 - 4 Alarm inputs, 2 Alarm outputs (5VTTL)
 - Variable speed from 0.1°/sec. to 380°/sec.
 - Three Variable speed (SLOW, NORMAL, TURBO)
 - Turbo speed is 380°/sec. with Ctrl key pressed.
 - Pan/Tilt speed is inversely proportional to the zoom ratio with the option.
 - Maximum speed is 380°/sec. when Preset command.
 - Auto Calibration from 0.1° to 6° (Tilt range is -10° to 190°)
 - Programmable user preferences (alarm, preset, title, etc.)
 - 180° Digital Flip
 - Up to 3999 selectable camera addresses
 - Function Run menu using DVR without function key (Pattern, Scan ...)
 - Built-in RS-485 receiver driver
 - 12VDC or 24VAC for Dome
 - Use satisfy clause 2.5 of IEC60950-1/UL60950-1 or Certified/Listed Class 2 power source only.

Chapter 2 — Installation and Configuration

2.1 Package Contents

The dome camera is designed with compact, small size, hard dome camera housing.

The housing is constructed of aluminum, steel and plastic. The housing is designed to be mounted on a wall or a ceiling. The housing meets the Protection Classification IP66 standards for dust and moisture resistance.

* Dome Camera	1
* Instruction Manual (This Document)	1
* Template Sheet	1
* Mounting Bracket	1
* Safety Lanyard	1
* Accessory Kit	1
1) Mounting screws (PH6 x 35.0)	(4)
2) Plastic anchors	(4)
3) O-Rings	(4)
4) Torx wrench	(1)
* Accessory Connector	1
1) 2-Pin Terminal Block	(1)
2) 3-Pin Terminal Block	(1)
3) 4-Pin Terminal Block	(1)
4) 5-Pin Terminal Block	(1)

2.2 Installation

The dome camera is for use in surface or pendent mounting applications, and the mounting member must be capable of supporting loads of up to 10 lb (4.5 kg). (Pendent mounting must use pendent mount accessory.)

The dome camera's mounting bracket should be attached to a structural object, such as hard wood, wall stud or ceiling rafter that supports the weight of the dome camera.

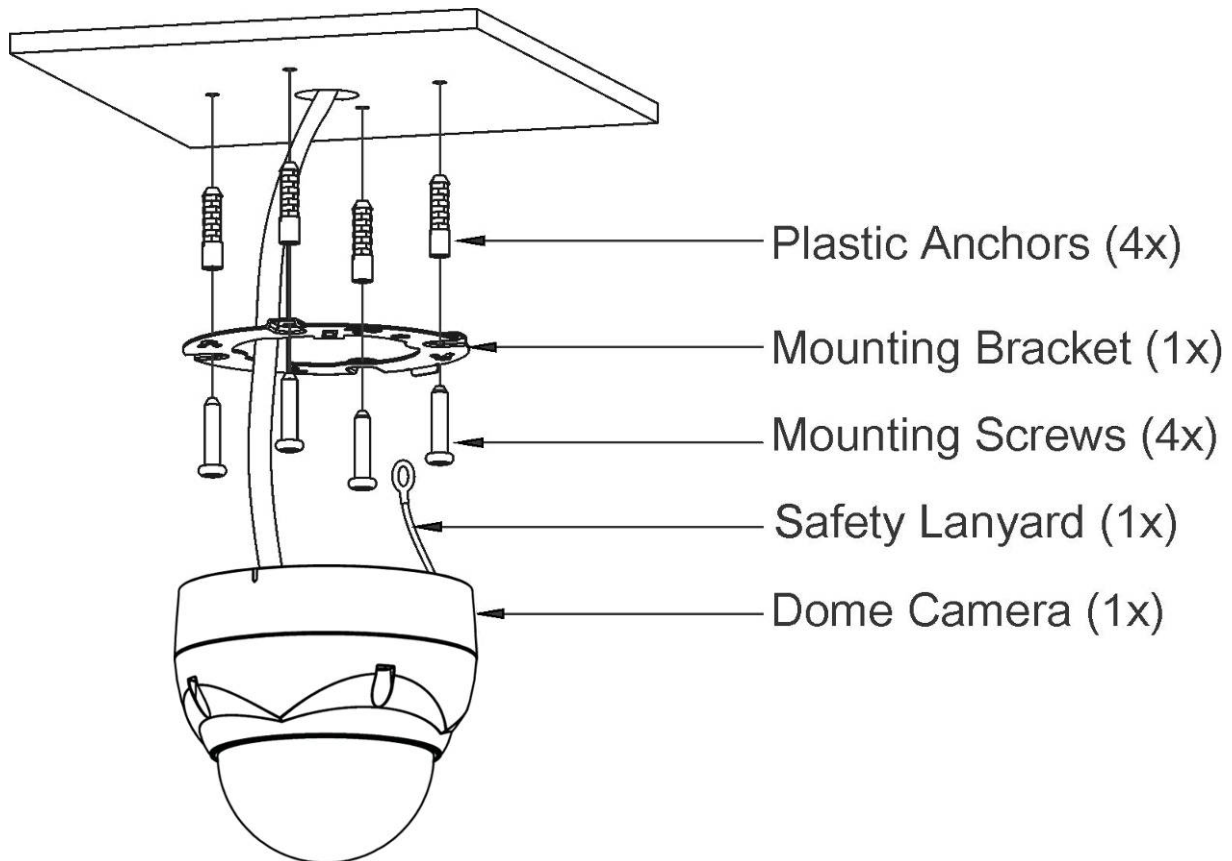

CAUTION: A silicone rubber sealant must be applied to seal the housing to secure waterproofing.

2.2.1 Locking Dome Camera

1. Make screw holes on the ceiling using the supplied mounting Template Sheet (Figure A).
2. Fix the Mounting Bracket to the ceiling using supplied Anchors (4x) and Mounting Screws (4x) (Figure B).
3. Hook up the Safety Lanyard to the Safety Lanyard Hook of the Mounting Bracket (Figure C).
4. Align the locking tab on the bracket and the locking slot on the base of the dome (Figure D).
5. Turn the dome to the counterclockwise about 10 degree to the locked position (Figure E).

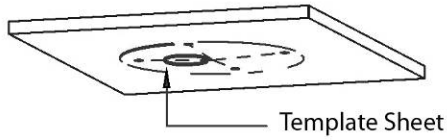

Figure A

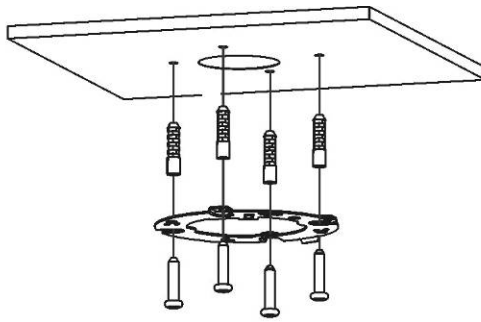

Figure B

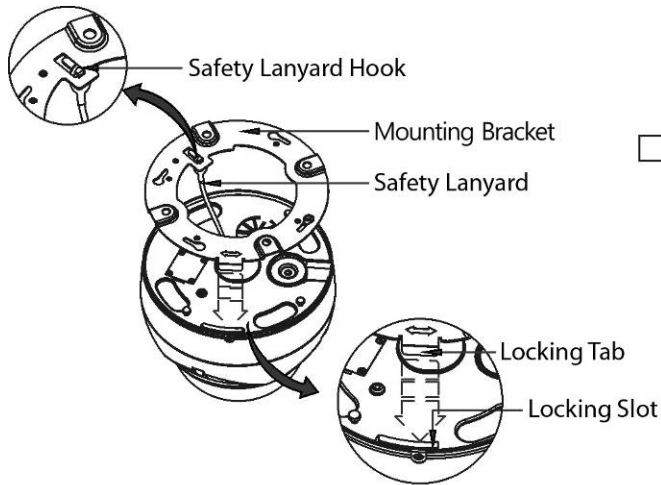

Figure C

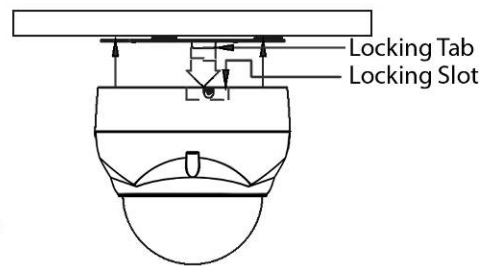

Figure D

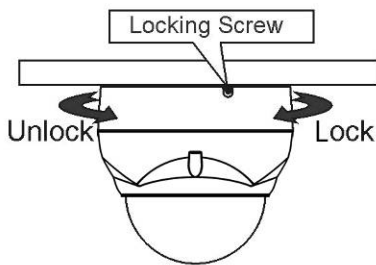

Figure E

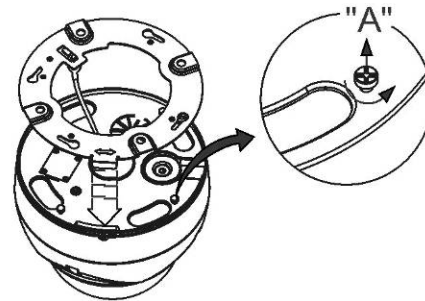

Figure F

CAUTION: Before installing mounting bracket to surface pre-adjust the four mounting screws "A" on the base of the dome camera to best match the mounting bracket locked position. Unscrew the locking screw on the side of the dome's base and fit the tab of the mounting bracket into the locking slot. Screws "A" should not be too tight or too loose when the dome is in the locked position. After setting the proper positions of screws "A" remove the mounting bracket and install it to the proper surface. If it is too difficult to lock the dome in position after the mounting bracket has been installed readjust the screws "A" by unscrewing them a small amount and try to install dome camera again.

2.2.2 Heater Kit Installation (Optional)

1. Assemble the Heater board to two bosses with screws.

Take a reference "B" in the bottom case as below.

2. Place the Heater in the slot "A".

Heater cable should be placed away from the Main Board.

3. Plug the power connector to the socket "C" (J1) of the Heater Board.

4. 24VAC is recommended to use for the camera power for stable operation with heater kit.

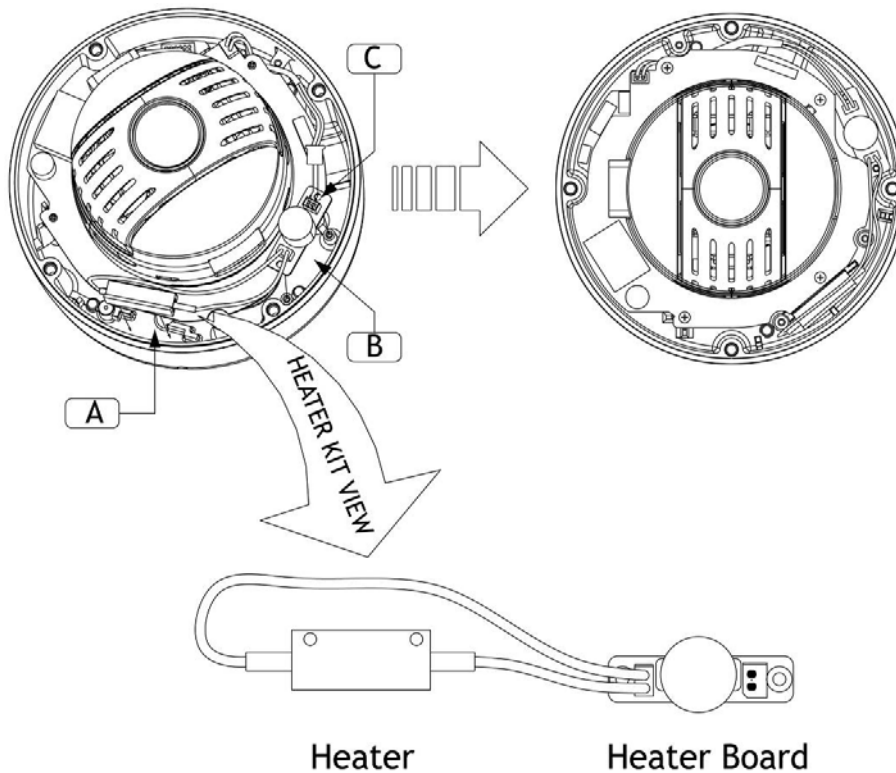

• HEATER (IF APPLICABLE)

Power Supply	24VAC
Power Consumption	10W
Heater ON	at 59°F (15°C)
Heater OFF	at 77°F (25°C)

• POWER

Use satisfy clause 2.5 of IEC60950-1/UL60950-1 or Certified/Listed Class 2 power source only.

CAUTION: Please reset the camera after 30 minutes when installing it in situations colder than -10°C.

2.3 Basic Configuration of Dome Camera System

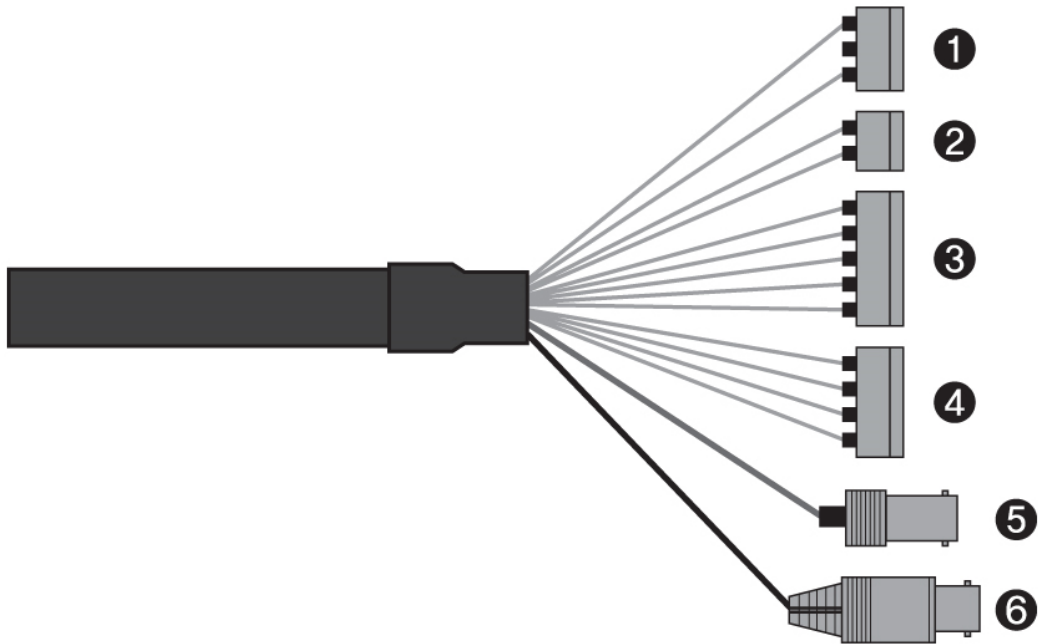

No.	Connector	Wire Color	Description
1	3-pin terminal block	RED	24VAC or 12VDC+
		WHITE	24VAC or 12VDC-
2	2-pin terminal block	GREEN	RS-485+
		BLUE	RS-485-
3	5-pin terminal block	GRAY	ALARM INPUT 1
		VIOLET	ALARM INPUT 2
		ORANGE	ALARM INPUT 3
		SKY BLUE	ALARM INPUT 4
		BLACK	GND
4	4-pin terminal block	YELLOW	ALARM OUTPUT 1
		BLACK & WHITE	GND
		SKY BLUE & BALCK	ALARM OUTPUT 2
		ORANGE & BLACK	GND
5	BNC jack	BLUE	HD-TVI/AHD OUTPUT
6	BNC jack	BLACK	CVBS OUTPUT

The dome camera must be installed by qualified service personnel in accordance with all local and federal electrical and building codes.

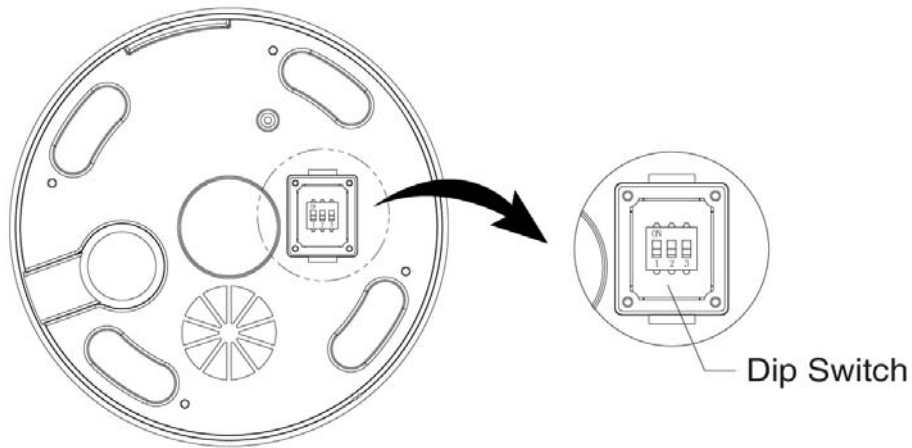

NOTE: Open the DIP switch cover and change the setting of DIP switch.
The cover should be closed after setting DIP switch.

2.4 Setting Dome Camera Address (ID)

To prevent damage, each dome camera must have a unique address (ID).
The factory default setting is 1.

Refer to '3.11 Dome Communication' section for detailed information.

2.5 Setting Dome Camera Video Type & Coaxitron Protocol

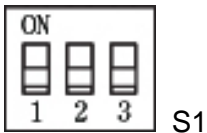

You can set video type with D1 in S1.

S1-D1	Video Type
OFF	HD-TVI OUTPUT
ON	AHD OUTPUT

You can set coaxitron protocol with D2 and D3 in S1.

S1-D2	S1-D3	HD-TVI OUTPUT	AHD OUTPUT
OFF	OFF	Hikvision-C	Hitron-C
ON	OFF	Pelco-C	Reserved
OFF	ON	Reserved	Reserved
ON	ON	Reserved	Reserved

2.6 Connections

- **Connecting to the RS-485**

The dome camera can be controlled remotely by an external device or control system, such as a control keyboard, using RS-485 half-duplex serial communications signals.

- **Connecting HD-TVI/AHD Output connector**

Connect the HD-TVI/AHD output (BNC) connector to the monitor or video input.

- **Connecting CVBS Output connector**

Connect the CVBS output (BNC) connector to the monitor or video input.

- **Connecting Alarms**

- **A1,A2,A3,A4 (Alarm Input 1,2,3,4)**

You can use external devices to signal the dome camera to react on events. Mechanical or electrical switches can be wired to the A1,A2,A3,A4 (Alarm Input 1,2,3,4) and G (Ground) connectors.

See Chapter 3 — Program and Operation for configuring alarm input.

- **G (Ground)**

NOTE: All the connectors marked G or GND are common.

Connect the ground side of the alarm input and/or alarm output to the G (Ground) connector.

- **AO1,AO2 (5VTTL Alarm Output 1,2)**

The dome camera can activate external devices such as buzzers or lights. Connect the device to the AO1,AO2 (Alarm Output 1,2) and G (Ground) connectors.

See Chapter 3 — Program and Operation for configuring alarm output.

- **Connecting the Power**

Connect power of 12VDC or 24VAC for the dome camera.

When using a 12VDC adapter, connect the positive (+) pole to the '+' position and the negative (-) pole to the '-' position.

Use satisfy clause 2.5 of IEC60950-1/UL60950-1 or Certified/Listed Class 2 power source only.

2.7 Getting Started

Once installed apply power to the dome camera. The dome camera will start a configuration sequence.

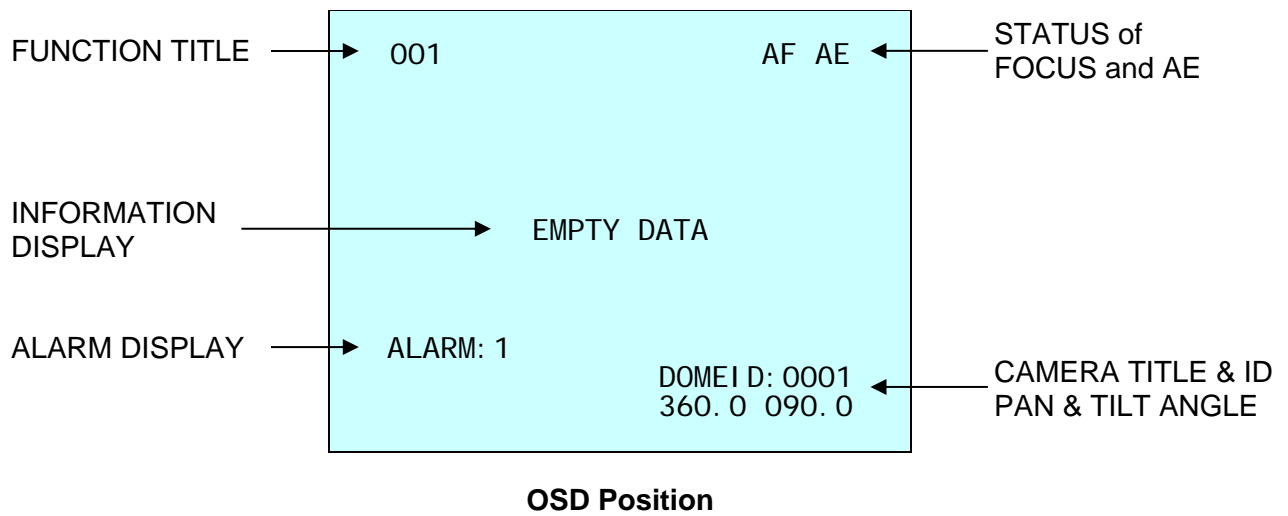

Chapter 3 — Program and Operation

3.1 Dome Camera Selection

Before you program or operate a dome camera, you must select the dome camera by pressing **No.** + **CAM** keys.

Example: Pressing **1** , **0** + **CAM** keys sequentially will select dome camera 10. The selected dome camera ID will be displayed on the LCD monitor of the keyboard controller.

3.2 Accessing the On-Screen Menu Utility

You can call up the On-screen menu utility on your monitor by pressing the **MENU** key on the keyboard controller, the following On-screen menu utility will appear:

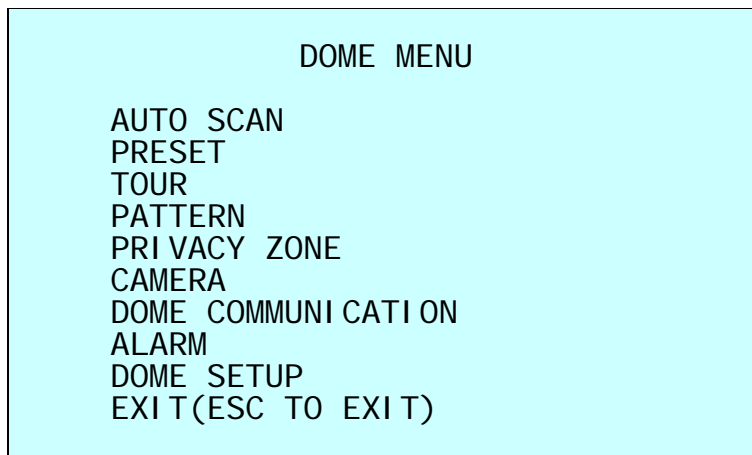

3.3 How to control the On-Screen Menu Utility

Function	Button
Call the On-screen menu utility.	MENU
Navigate through the menu items.	Joystick up or down
Go into the sub-menu items.	Joystick left or right or IRIS Open
Change value. Enter the editing title mode.	Joystick left or right or Zoom handle twist or Tele , Wide
Change value of angle.	CTRL + Joystick
Enter the changing angle mode.	IRIS Open
Exit the changing angle mode.	IRIS Close
Escape (EXIT)	ESC

3.4 Auto Scan (Shortcut: **SCAN**)

The Auto Scan supports up to 17 programmed angles at user-programmable speeds. Follow these steps to program Auto Scan:

```

                AUTO SCAN SETUP

NUMBER          : 01
TITLE           : A01
MODE            : NORMAL
SPEED           : 5 STEP
START ANGLE     : -----
END ANGLE       : -----
SCAN DIR        : CCW
SWAP            : OFF
DWELL           : 03 SEC
SAVE AND EXIT(ESC TO CANCEL)
    
```

- NUMBER** 01 ~ 08, 10 ~ 17, **09**: AUTO-PAN mode.
- TITLE** up to 6 characters
- MODE** NORMAL, VECTOR, RANDOM (AUTO-PAN mode: NORMAL, RANDOM only).
 - NORMAL Move from start point to end point in panning only
 - VECTOR Move from start point to end point including tilt and zoom simultaneously and linearly.
 - RANDOM Move randomly between the start point and the end point
- SPEED** 1 ~ 13 step, the lower number means the slower speed.
- SCAN DIR** Set the Scan direction, CCW (Counter Clock Wise), CW (Clock Wise).
- SWAP** Swaps the start point for the end point.
- DWELL** Set the dwell time at the both end, 01 ~ 99 seconds.

1. Press the **SCAN** key to enter the Auto Scan menu directly. Or press the **MENU** key to display the main menu on the monitor. Scroll to Auto Scan and push the **Joystick** to the right.
2. Select “**NUMBER**” and set the desired number by pushing the **Joystick** to the left or right.
3. Select “**TITLE**” and twist the **Joystick** to enter the title edit mode.
4. Twist the **Joystick** to change the alphanumeric characters and move the next position by pushing the **Joystick** to the left or right. Or move down to the character table and press the **CTRL** or **IRIS Open** key at the desired character then the cursor position moves to the next position automatically. Push the **Joystick** to the left or right at the “ALL DELETE” field to delete all characters. Push the **Joystick** to the left or right at the “EXIT” field to finish title edit menu.

```

                TITLE EDIT MENU
                (CTRL KEY)

A01
*

A B C D E F G H I J
K L M N O P Q R S T
U V W X Y Z 0 1 2 3
4 5 6 7 8 9 ( )
ALL DELETE
EXIT(ESC TO EXIT)
    
```



5. Select “**MODE**” and “**SPEED**”.
6. Select “**START ANGLE**”. Hold down the **CTRL** key while selecting the start position using the **Joystick**. Current panning position will be displayed. Release the **CTRL** key to complete the selection of the start position. Or press the **IRIS Open** key then the “CONTROL” displays. Move the desired position and the zoom position. Press the **IRIS Close** key then the “CONTROL” disappears. To adjust at the 0.1 degree interval, twist the **Joystick** at the pan field and the tilt field.
7. Select “**END ANGLE**”. Hold down the **CTRL** key while moving the **Joystick** to select the end position. The end position angle should be larger than start position. Release the **CTRL** key to complete the selection of the end position. Or press the **IRIS Open** key then the “CONTROL” displays. Move the desired position and the zoom position. Press the **IRIS Close** key then the “CONTROL” disappears. To adjust at the 0.1 degree interval, twist the **Joystick** at the pan field and the tilt field.
8. Set “**SCAN DIR**” to CCW or CW.
9. Select “**SWAP**”, Set to ON to exchange the start angle and the end angle.
10. Set “**DWELL time**”.
11. Select “**SAVE AND EXIT**” and push the **Joystick** to the right or press the **IRIS Open** key. Press the **ESC** or **IRIS Close** key to exit the program without saving.

NOTE: Pressing the HOME key delete stored data at the angle field.

To set the position using the Preset position:

- a. Before entering the Auto Scan menu, select a Preset position as a starting point for Auto Scan.
Example: **2** + **PRST** keys and do step 1 to 5. In step 6, just press the **CTRL** key at the start angle position, the current position will be displayed as a start position.
- b. Save and Exit from the menu.
- c. In normal mode, call a Preset to be the end point of Scan. Press **3** + **PRST** keys then press the **SCAN** key to enter the Auto Scan menu. Move the cursor position to END ANGLE. Just press the **CTRL** key at the end angle position. Save and exit from the menu.

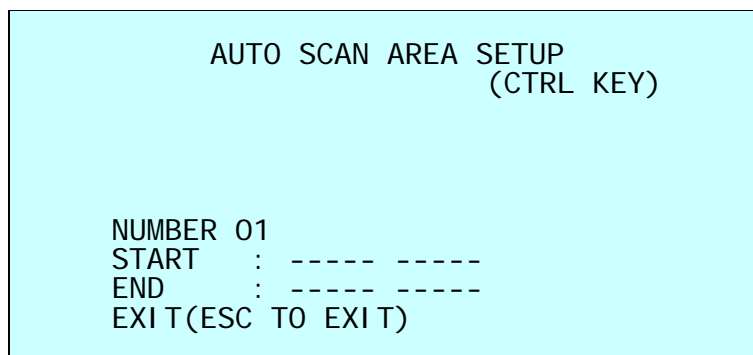
Press the **SCAN** key on the angle field to display with the small OSD. Then the screen will show as below.



The setting procedure is the same as above.

NOTE: 09: AUTO-PAN mode (endless panning)

3.5 Preset (Shortcut: **PRST**)

If you need to view specific places routinely, you should program Presets. A Preset is a programmed video scene with automatic pan, tilt, zoom, focus, and AE settings. Once programmed, placing the number position and pressing the **PRST** key on your controller calls up that Preset automatically. In addition, Presets may be assigned the “home” position for the dome camera. As many as 240 Presets, whose positions are saved in the dome’s firmware, may be programmed.

There are eight pages of Preset menu. Each page has 30 Presets. Pages can be scrolled by pushing the **Joystick** to the left or right on the first or last No. of Preset.

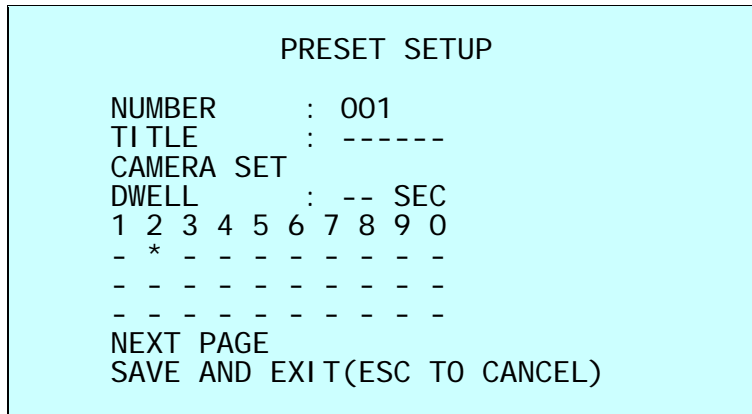

- Blank Preset position
- * Position has the Preset
- ! Current cursor position

Follow steps below to store the Preset positions:

1. Press the **PRST** key to enter the Preset menu directly. Or press the **MENU** key to display the main menu on the monitor. Scroll to Preset and push the **Joystick** to the right.
2. Select the blank Preset position to be stored by pushing the **Joystick** up, down, right, or left.
3. After selecting a blank position, press and hold the **CTRL** key. Use the **Joystick** to control the direction of the camera and lens.
4. After aiming the camera (view direction and lens control), release the **CTRL** key. The cursor will be on the “TITLE” after saving data then twist the **Joystick** or press the **Tele** or **Wide** key to edit the Preset title. Follow the procedure of the Auto Scan above to edit titles.
5. Select “CAMERA SET” and push the **Joystick** to the left or right. Then the Preset camera setup displays.

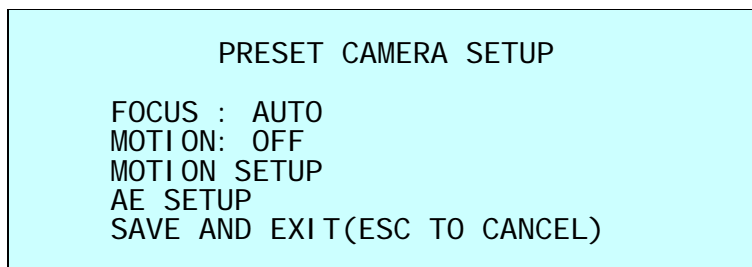

- Set **FOCUS** AUTO, MANUAL, ONE PUSH
- Set **MOTION** OFF, ON

Select "**MOTION SETUP**" and push the **Joystick** to the left or right. Then the MOTION setup displays.

```
MOTION SETUP

SENSITIVITY: 10
RESOLUTION : 02
POSITION    : ALL
DELAY       : 00 SEC
OUTPUT      : OFF
HOLD TIME   : 03 SEC
EXIT(ESC TO EXIT)
```

Set SENSITIVITY	00 ~ 20
Set RESOLUTION	01 ~ 04
Set POSITION	ALL, CENTER
Set DELAY	00 ~ 05 seconds
Set OUTPUT	OFF, OUT1, OUT2
Set HOLD TIME	03 ~ 99 seconds

Select "**AE SETUP**" and push the **Joystick** to the left or right. Then the AE setup displays. Refer to the AE SETUP in the camera setup.

- Set "**DWELL time**". (03 ~ 99 seconds)
- To select the next page of Presets, scroll the page by pushing the **Joystick** to the left or right on the first or last columns of the menu.
- Repeat step 2 through 7 for each additional Preset position.
- Select "**SAVE AND EXIT**" and push the **Joystick** to the right or press the **IRIS Open** key. Press the **ESC** or **IRIS Close** key to exit the program without saving.

NOTE: Press the **HOME key at programmed Preset position (*) to delete a programmed Preset view.**

The position, which is marked with the *, already has the Preset view assigned. Press the **PRST** key on the * to review the stored Preset. The camera will show the stored Preset scene.

```
PRESET AREA SETUP
                    (CTRL KEY)

NUMBER 001
PAN    TILT
000.0 000.0
EXIT(ESC TO EXIT)
```

Hold down the **CTRL** key while selecting the desired scene using the **Joystick**. Current position will be displayed. Release the **CTRL** key to complete. Or press the **IRIS Open** key then the "CONTROL" displays. Move the desired position and the zoom position. Press the **IRIS Close** key then the "CONTROL" disappears. Select "EXIT" and push the **Joystick** to the right.

3.6 Shortcut of Preset Program

After selecting the desired scene, press No. (1 to 240), and press the **CTRL** and **PRST** keys subsequently. The current view will be stored to the selected Preset number if the Preset number is empty. If selected Preset number is not empty, "OVER WRITE" message will be displayed on the monitor and select the "OK" and push the **Joystick** to the right to overwrite.

Example: **1**, **0**, **1** + **CTRL** + **PRST** keys will store current view as Preset no. **101**. In this case, focus will be programmed as Auto, dwell time will be set to 3 second, and the current AE mode will be programmed.

3.7 Tour (Shortcut: **TOUR**)

There are 8 programmable Tours. Each Tour consists of up to 42 Preset positions, Patterns, Scans or other Tours (second-level). Using second-level Tours, it can be expanded to over 300 functions in a single Tour.

```

          TOUR SETUP

NUMBER          : 01
TITLE           : T01
SCAN TYPE      : NORMAL
SPEED          : -- STEP
TOUR FUNC
SAVE AND EXIT(ESC TO CANCEL)
    
```

```

          TOUR FUNC SETUP
                      (CTRL KEY)
DWELL              : -- SEC
003 A04 --- --- ---
--- --- --- ---
--- --- P01 --- ---
--- T02 --- --- ---
--- --- --- ---
--- --- --- ---
--- --- --- ---
EXIT(ESC TO EXIT)
    
```

---	Blank position
SCAN TYPE	NORMAL, VECTOR
DWELL	03 ~ 99 seconds
003	Preset (1 ~ 240)
A04	Auto Scan (1 ~ 8, 10 ~ 17)
P01	Pattern (1 ~ 8)
T02	Tour (1 ~ 8)

Follow the steps below to program the Tours:

1. Press the **MENU** key to display the main menu on the monitor. Scroll to Tour and push the **Joystick** to the right to enter the Tour menu. Or just press the **TOUR** key on the keyboard.
2. Select "NUMBER" and set the desired number by pushing the **Joystick** to the left or right.
3. Choose a blank position to be programmed by pushing the **Joystick** up, down, right, or left.

4. To add a stored Preset, twist the **Joystick** then the stored Preset number displays.
5. To place functions other than Preset, press the **TOUR**, **PTRN** or **SCAN** keys for Tour, Pattern or Auto Scan respectively.
6. You can also overwrite the programmed number and remove a stored number from the Tour, press the **HOME** key on the stored number, a blank position mark (---) will be displayed.
7. Repeat step 2 through 6 for each desired position. Each title will be displayed on top of the line.
8. To edit the "TITLE", follow the procedure of the Auto Scan above to edit titles.
9. Select "SAVE AND EXIT" and push the **Joystick** to the right or press the **IRIS Open** key. Press the **ESC** or **IRIS Close** key to exit the program without saving.

You can expand the Tour sequence by calling other programmed Tours.

NOTE: The speed applies in the vector mode only.

NOTE: In the Tour mode, in conjunction with Preset and Auto Scan, you can make the camera travel from a Preset position to another Preset position at a specific speed.

Example: Preset 001>002>003>004>005>006, Auto Scan 01 starts at Preset 002, ends at Preset 003, Auto Scan 02 starts at Preset 005, ends at Preset 006;
Tour 001, 002, A01, 004, A02.

1 → 2 2~3 → 4 → 5~6, repeat
where → : Quick move, ~ : Programmed speed

To change the dwell time of the Preset in the Tour:

Use the **Joystick** to move the cursor to a stored Preset position.

By pressing the **PRST** key, the camera will move to the stored Preset view and the cursor moves to the dwell time field.

After changing the dwell time, press the **PRST** key and the cursor moves to the Preset number.

To assign the functions other than Preset in the Tour when the function key is not existed:

Use the **Joystick** to move the cursor to a stored Preset position.

Pressing the **CTRL** or **IRIS Open** key will change the Preset number to other function (Auto Scan, Pattern, Tour or Preset) with the first programmed number.

To change the number, twist the **Joystick** or press the **Tele** or **Wide** key.

3.8 Pattern (Shortcut: PTRN)

The Pattern feature records user control of the selected dome camera. Up to 8 Patterns can be stored and played back by pressing **No.** + **PTRN** keys subsequently.

PATTERN SETUP			
NO	TITLE	SEC	PERCENT (CTRL KEY)
1	: P01	000	00.0%
2	: P02	000	00.0%
3	: P03	000	00.0%
4	: P04	000	00.0%
5	: P05	000	00.0%
6	: P06	000	00.0%
7	: P07	000	00.0%
8	: P08	000	00.0%
SAVE AND EXIT(ESC TO CANCEL)			

Follow steps below to program the Pattern:

1. Press the **MENU** key to display the main menu on the monitor. Scroll to Pattern and push the **Joystick** to the right to enter the Pattern menu. Or just press the **PTRN** key on the keyboard.
2. Select the desired Pattern to be programmed by pushing the **Joystick** up or down. If the Pattern is not 000, a Pattern has already been recorded. Patterns can be overwritten.
3. Press and hold down the **CTRL** key while controlling the camera direction and zoom with the **Joystick**. The dome will be automatically recorded until you release the **CTRL** key. Or press the **IRIS Open** key then the "CONTROL" displays. Move the position and the zoom position. Press the **IRIS Close** key then the "CONTROL" disappears.
4. To edit the "TITLE", follow the procedure of the Auto Scan above to edit titles.
5. Select "SAVE AND EXIT" and push the **Joystick** to the right or press the **IRIS Open** key. Press the **ESC** or **IRIS Close** key to exit the program without saving.

NOTE: Press the HOME key at any programmed position to delete the Pattern.

NOTE: If Pattern recording time reaches 200 seconds, it will automatically stop for a moment.

Press the **PTRN** key on the title field to display with the small OSD. Then the screen will show as below.

PATTERN AREA SETUP	
(CTRL KEY)	
NUMBER 01	
000	00.0%
EXIT(ESC TO EXIT)	

The setting procedure is the same as above.

3.9 Privacy Zone

Hide up to 8 unwanted scenes in a camera.

There are two pages of Privacy Zone menu. Each page has 4 Privacy Zones.

PRIVACY ZONE SETUP			
(CTRL KEY)			
NO		METHOD	COLOR
01	ON	BLOCK	BLACK
02	ON	BLOCK	BLACK
03	OFF	-----	BLACK
04	OFF	-----	BLACK
NEXT PAGE			
SAVE AND EXIT(ESC TO CANCEL)			

1. Place the cursor at the field.
2. Hold down the **CTRL** key displays the privacy area menu while selecting the position using the **Joystick**. Current position will be displayed. Release the **CTRL** key to complete the selection of the position. Or press the **IRIS Open** key then the privacy area menu displays. Move the desired position. Press the **IRIS Close** key then the "CONTROL" disappears.

To adjust the size, twist the **Joystick** or press the **Tele** or **Wide** key.

Returns to the previous menu.

PRIVACY AREA MENU	
(CTRL KEY)	
NUMBER 01	
354.8	344.8
EXIT(ESC TO EXIT)	

3. To turn the stored zone ON or OFF, twist the **Joystick** or press the **Tele** or **Wide** key.
4. Set the "COLOR": "BLACK", "WHITE", "YELLOW", "CYAN", "GREEN", "MAGENTA", "RED" or "BLUE".
5. Select "SAVE AND EXIT" and push the **Joystick** to the right or press the **IRIS Open** key. Press the **ESC** or **IRIS Close** key to exit the program without saving.

NOTE: Press the **HOME** key to delete programmed Privacy Zone at the title field.

3.10 Camera Menu

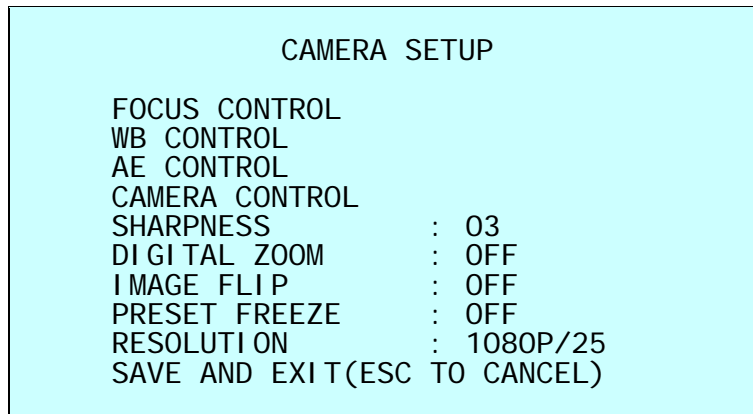

- SHARPNESS** The higher the value, the more edges in the picture will be enhanced.
(0 ~ 10)
- DIGITAL ZOOM** OFF: Zoom range is limited to the optical.
2X: Zoom is extendable up to 2X of digital range.
4X: Zoom is extendable up to 4X of digital range.
8X: Zoom is extendable up to 8X of digital range.
MAX: Zoom is extendable Max digital zoom range.
- IMAGE FLIP** This function turns the video output from the camera upside down and reverses it horizontally.
This option is helpful to install in the opposite side.
- PRESET FREEZE** ON: the image is frozen during calling Preset.
- RESOLUTION** HD-TVI Output: 1080P/30, 1080P/25, 720P/60, 720P/50, 720P/30, 720P/25
AHD Output: 1080P/30, 1080P/25

• FOCUS CONTROL

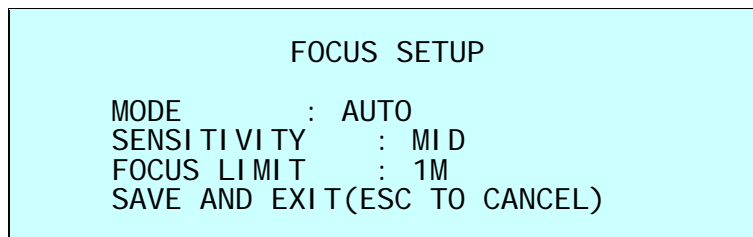

- MODE** AUTO, MANUAL, ONE PUSH, CONST MANUAL
Use manual mode in normal use.
- SENSITIVITY** LOW, LOW.MID, MID, MID.HIGH, HIGH
- FOCUS LIMIT** This distance is approximate value and the focus operates from the setting value.

CAUTION: Avoid continuous, 24-hour use of the auto focus. This will shorten the lifespan of the lens.

• **WB (White Balance) CONTROL**

```

                                WB SETUP

MODE                : AUTO
R GAIN              : ---
B GAIN              : ---
SAVE AND EXIT(ESC TO CANCEL)

```

MODE AUTO, MANUAL, INCANDESCENT, FLUORESCENT, OUTDOOR

- AUTO Computes the white balance value output using color information from the entire screen automatically.
- INCANDESCENT Auto white balance mode that is compatible with incandescent lamps.
- FLUORESCENT Auto white balance mode that is compatible with fluorescent lamps.
- OUTDOOR Outdoor white balance mode
- MANUAL Manual mode, you can change R and B Gain manually.

R GAIN 0 ~ 255
 B GAIN 0 ~ 255

R GAIN / B GAIN modes are controllable only in MANUAL Mode.

• **AE CONTROL**

```

                                AE SETUP

MODE                : AUTO
DSS                 : OFF
IRIS                : AUTO
SHUTTER             : AUTO
BRIGHT              : 10
GAIN LIMIT          : 07
NIGHT SHOT         : AUTO
ADDITIONAL AE
SAVE AND EXIT(ESC TO CANCEL)

```

MODE AUTO, MANUAL, I.PRIO, S.PRIO

- AUTO Auto exposure mode
- MANUAL Variable Iris, Shutter speed
- I.PRIO Variable Iris, Auto Shutter speed
- S.PRIO Variable Shutter speed, Auto Iris

DSS OFF, x2 ~ x8
IRIS F1.8 ~ F32
SHUTTER 1/25 (30) ~ 1/30000
BRIGHT 0 ~ 20
GAIN LIMIT 0 ~ 7
NIGHT SHOT AUTO, ON, OFF, GLOBAL

NOTE: Values in () are for NTSC Camera.

The NIGHT SHOT option removes the IR cutoff filter of the camera and makes the camera sensitive to near infrared.

AUTO Camera goes in to B&W mode at low light.
GLOBAL Controlled by the keyboard

(NOTE: GLOBAL function operates F2E protocol only)

The operator can enable NIGHT SHOT for all dome cameras at the same time.

If the NIGHT SHOT mode is set to GLOBAL, "999" + **ENTER** will turn Off the NIGHT SHOT mode and "888" + **ENTER** will turn On the NIGHT SHOT mode.

ON B/W mode
OFF Color mode

NOTE: AUTO in NIGHT SHOT function is not applied in "MANUAL" mode of AE Control.

ADDITIONAL AE

ADDITIONAL AE SETUP	
ACE	: OFF
WDR	: OFF
WDR WEIGHT	: --
BLC	: OFF
HLC	: OFF
HLC LEVEL	: --
HLC COLOR	: ---
DEFOG	: OFF
EXIT(ESC TO EXIT)	

ACE OFF, LOW, MID, HIGH
WDR OFF, ON, NIGHT OFF (**NOTE: When ON, BLC will be disabled.**)
WDR WEIGHT LOW, MID, HIGH
BLC OFF, ON (**NOTE: When ON, WDR will be disabled.**)
HLC OFF, ON
HLC LEVEL 0 ~ 20
HLC COLOR BLACK, WHITE, YELLOW, CYAN, GREEN, MAGENTA, RED, BLUE
DEFOG OFF, ON

• CAMERA CONTROL

CAMERA CONTROL	
D->N LEVEL	: 070
N->D LEVEL	: 030
D/N DELAY	: 03 SEC
CHROMA	: 08
GAMMA	: 2
DNR	: MID
DIS	: OFF
SAVE AND EXIT(ESC TO CANCEL)	

D->N LEVEL 0 ~ 255
N->D LEVEL 0 ~ 255
D/N DELAY 1 ~ 60 seconds
CHROMA 0 ~ 20
GAMMA 0 ~ 4
DNR OFF, LOW, MID, HIGH
DIS OFF, ON

3.11 Dome Communication

To prevent damage, each dome camera must have a unique address (ID).
The factory default setting is 1.

```

                                DOME COMMUNICATION
                                *
DOME ID       : 0001
PROTOCOL      : AUTO
BAUDRATE      : 9600
PARITY        : NONE
TERMINATION   : OFF
SAVE AND EXIT(ESC TO CANCEL)

```

DOM E ID	1 ~ 3999
PROTOCOL	AUTO, F2/F2E, PELCO-PD
BAUDRATE	2400, 4800, 9600, 19200, 38400 bps
PARITY	NONE, EVEN, ODD
TERMINATION (RS-485)	OFF, ON

3.12 Alarm

```

                ALARM SETUP
                (CTRL KEY)
NO  PRI  FUN  IN   OUT  HLD  LATCH
1   1    001 NO   OUT1 03   OFF
2   1    --- OFF  OFF  03   OFF
3   1    --- OFF  OFF  03   OFF
4   1    --- OFF  OFF  03   OFF
DWELL      : 03 SEC
ALARM OUT SETUP
SAVE AND EXIT(ESC TO CANCEL)

```

- NO (Number)** alarm input number
- PRI (Priority)** the lower number has higher priority (0 ~ 4)
- FUN (Function)** Stored function number to be called by alarm.
- IN (Input)** NO/NC – normally open/closed, OFF – ignore
- OUT (Output)** OUT1 ~ OUT2 – 5VTTL output, OFF – no output
- HLD (Hold)** Alarm will be held for programmed time. (03 to 99 seconds)
- LATCH** ON – Alarm message will remain on the screen even though alarm input is deactivated.
OFF – Alarm message will disappear from the screen after programmed hold time when alarm input is deactivated.
- DWELL** means the dwell time during multiple alarms, 03 to 99 seconds.

```

                ALARM OUT SETUP

OUT1   : ALARM
OUT2   : 1 MIN
EXIT(ESC TO EXIT)

```

ALARM: alarm output is operated during an alarm operation or by the short key of our keyboard.

1 ~ 5 MIN (minute): alarm output is operated during this setting time only by the function run of the dome menu or the short key of our keyboard.

NOTE: This 1 ~ 5 MIN setting is not operated by an alarm.

There are 5 levels of priority. The function can be selected by Preset, Auto scan, Pattern or Tour and “0” is the highest priority. Lower priority alarms won’t be serviced until the higher priority alarm is completed. Equal priority alarms will be serviced repeatedly with the dwell time.

3.13 Dome Setup

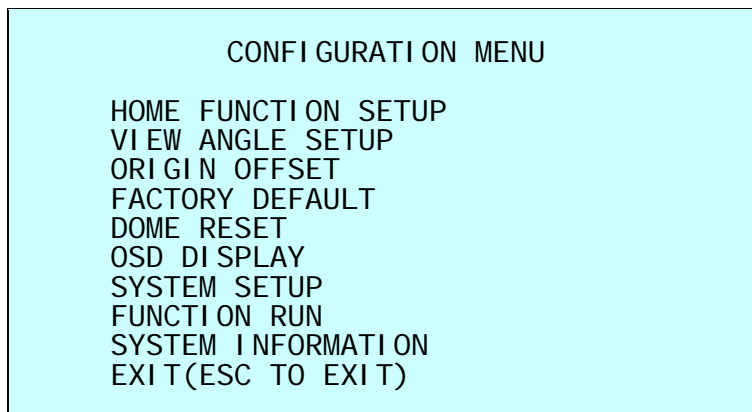

• HOME FUNCTION SETUP

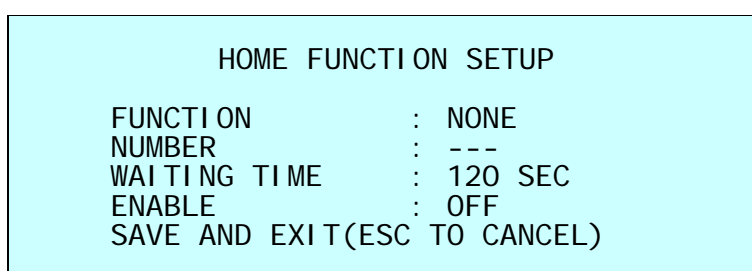

FUNCTION	NONE, TOUR, PATTERN, AUTO SCAN, PRESET
NUMBER	---
WAITING TIME	10 ~ 240 seconds
ENABLE	ON, OFF

The Home Function can be set so that the camera automatically goes to Tour, Pattern, Auto Scan or Preset after the keyboard controller has been idle for a specified amount of time.

For example, if the controller is idle for 120 seconds, the camera goes to Preset 1.

Follow these steps to program the Home position:

1. Select “**FUNCTION**” by pushing the **Joystick** to the left or right to scroll through the None, Tour, Pattern, Auto Scan or Preset functions.
2. Select “**NUMBER**” and push the **Joystick** to the left or right. The recorded function number will scroll.
3. Select “**WAITING TIME**” and push the **Joystick** to the left or right to select from 10 to 240 seconds.
4. Select “**ENABLE**” and turn to ON or OFF by pushing the **Joystick** to the left or right.

• VIEW ANGLE SETUP

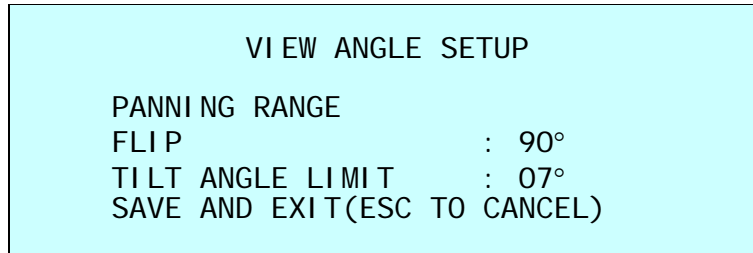

FLIP OFF, AUTO, 90°, 100°, 110°, 120°

OFF: The dome camera moves until 90° vertically.

AUTO: When the camera reaches the floor directly above the moving object, it will stop.

At that time, release the **Joystick** instantly and pull it down again to run the auto-flip function. When you use the panning range, it is recommended to use the flip mode to AUTO.

90°, 100°, 110°, 120°: Allows the image to flip digitally when the camera moves over the setting angle vertically.

TILT ANGLE LIMIT -10° ~ 10°

This option is designed to limit the view angle as there is some obstruction in zooming out on specific areas of the tilt angle.

NOTE: Focus issues may occur in certain conditions.

PANNING RANGE

When the dome camera is installed near a wall, panning range can be limited by user.

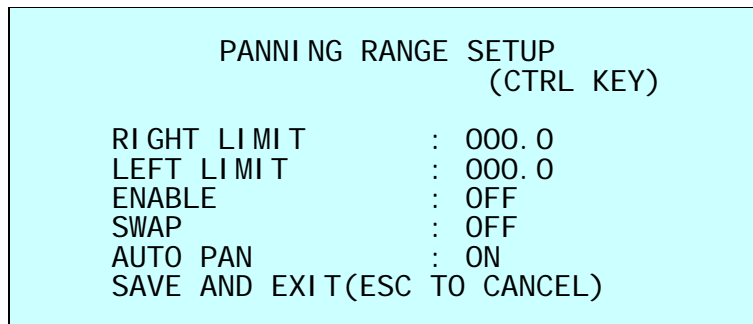

1. Place the dome camera under 90 degree vertically.
2. Set "**RIGHT LIMIT**" by pushing the **Joystick** to the right.
3. Set "**LEFT LIMIT**" by pushing the **Joystick** to the left.
4. Set "**ENABLE**" to ON to use.

To exchange the right and the left limit, set "**SWAP**" to ON.

To apply limits on the auto pan (endless panning), set "**AUTO PAN**" to ON.

NOTE: When the flip mode is 90°, 100°, 110° or 120° and you moves over 90° vertically, the panning range operates in opposite side.

- **ORIGIN OFFSET**

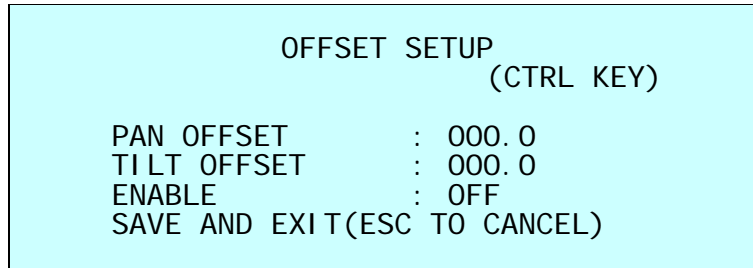

This feature is useful to align a new dome camera exactly the same as the previously installed dome camera.

Dome camera's origin set and all data initialize option do not override offset values. Only the default set option in this menu will set the offset value to zero. This can be used to avoid ceiling obstructions.

- **FACTORY DEFAULT**

Select "**FACTORY DEFAULT**" to initialize the data.

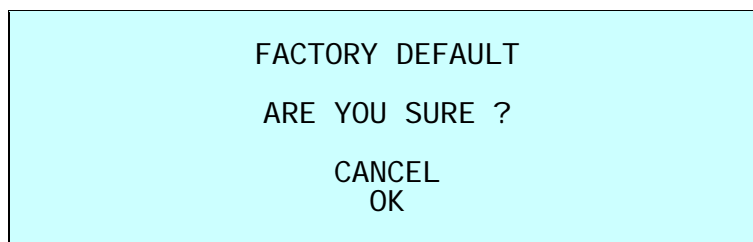

- **DOMES RESET**

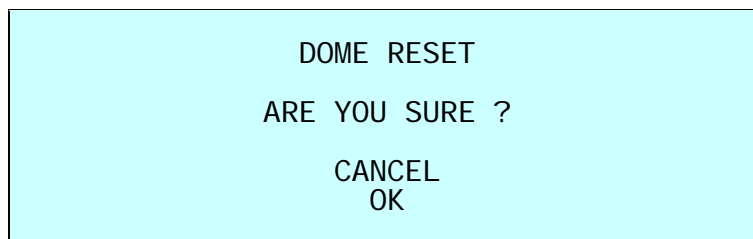

This feature is used to re-calibrate the orientation of a selected dome camera. Origin offset value is not affected by this function. (Offset is still valid after origin set.)

• **OSD DISPLAY**

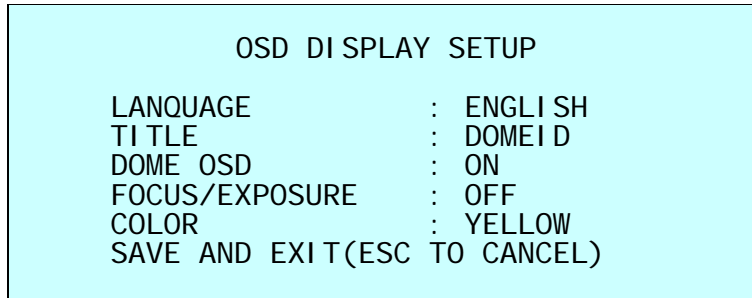

- LANGUAGE** Select the desired language.
- TITLE** up to 6 characters
- DOME OSD** ON, POSITION, ON(ZOOM), ZOOM, OFF
All display or title will disappear when DOME OSD DISPLAY is set to OFF.
- FOCUS/EXPOSURE** ON, OFF
ON: FOCUS and EXPOSURE displays. (AF AE)
- COLOR** YELLOW, GRAY, BLUE

• **SYSTEM SETUP**

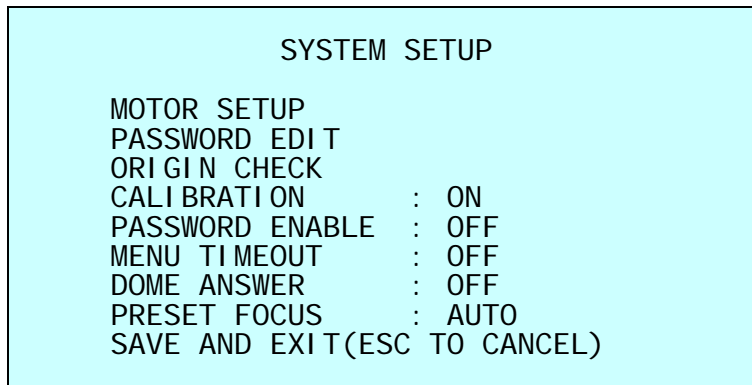

- CALIBRATION** ON (Auto origin check), OFF
- PASSWORD ENABLE** ON (requires the password to enter menu), OFF
- MENU TIMEOUT** ON (5 minutes), OFF (always menu display)
- DOME ANSWER** ON, OFF (no acknowledge command from the dome)
This option is helpful to escape the collision of the command using some DVR.
- PRESET FOCUS** AUTO, MANUAL, ONE PUSH
This option set the default mode of the focus when you save the Preset.

MOTOR SETUP

Motor Setup menu provides the pan and tilt speed of a camera. User can set the desired speed with pushing the **Joystick** to the left or right. During operation, pressing **153** + **ON** keys will change the speed to the SLOW mode and pressing **153** + **OFF** keys will change the speed to the NORMAL mode.

Press and hold the **CTRL** key and moving the **Joystick** will operate with the TURBO speed mode.

MOTOR SETUP	
PROPORTIONAL P/T	: ON
P/T MODE	: NORMAL
SLOW PAN MAX	: 40
SLOW TILT MAX	: 40
NORMAL PAN MAX	: 90
NORMAL TILT MAX	: 90
TURBO PAN MAX	: 360
TURBO TILT MAX	: 100
SAVE AND EXIT(ESC TO CANCEL)	

PROPOTIONAL P/T

ON, OFF

P/T MODE

SLOW, NORMAL, TURBO

SLOW PAN Maximum speed	19° ~ 90°/second
SLOW TILT Maximum speed	19° ~ 90°/second
NORMAL PAN Maximum speed	40° ~ 360°/second
NORMAL TILT Maximum speed	40° ~ 200°/second
TURBO PAN Maximum speed	200° ~ 380°/second
TURBO TILT Maximum speed	90° ~ 300°/second

PASSWORD EDIT

PASSWORD EDIT SETUP (CTRL KEY)	
INPUT PASSWORD	
PASSWORD:	
A B C D E F G H I J	
K L M N O P Q R S T	
U V W X Y Z 0 1 2 3	
4 5 6 7 8 9 ()	
SAVE AND EXIT(ESC TO CANCEL)	

You can change the password with 6-digit character in this menu.

The default password is **555555**.

When the password enable is on, the input password window displays to enter the menu. At this time, move the cursor to the desired character with the **Joystick** and press the **CTRL** or **IRIS Open** key.

ORIGIN CHECK

If you find the dome in the wrong position during operation, execute this origin check and the dome camera will return to the right position after the origin check operation.

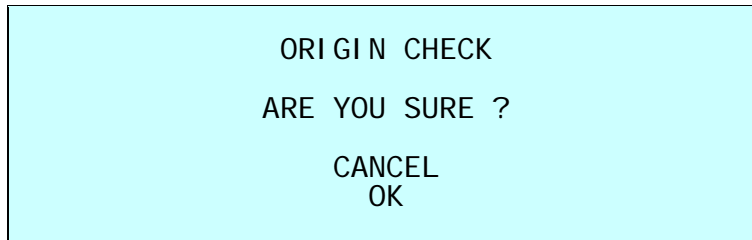

Pressing **151** + **ON** keys will execute the origin check.

• FUNCTION RUN

This Function Run menu allows you to execute the function when you use a keyboard or a DVR without the function keys (Preset, Pattern, Tour and Scan).

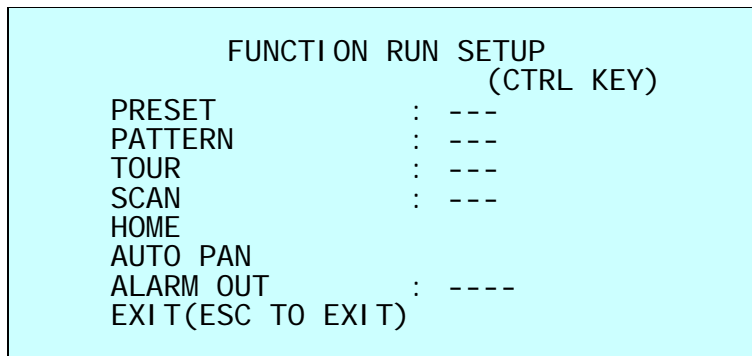

1. Select the desired Function by pushing the **Joystick** up or down.
2. Select the number by twist the **Joystick** in PRESET, PATTERN, TOUR and SCAN.
3. Press the **CTRL** or **IRIS Open** key to execute.

NOTE: To execute the function, you should save the function (PRESET, PATTERN, TOUR and SCAN) first.

- HOME

Select "HOME" and press the **CTRL** or **IRIS Open** key. The dome camera goes to the default position that it returns to after an assigned period of inactivity passes. The default position may be a Preset, Tour, Pattern or no action.

- AUTO PAN

You can execute the endless auto pan to turn in one direction continuously by selecting Auto-Pan.

- ALARM OUT

This function can operate only when the alarm out setup has the time in the alarm menu.

Ex)

```
ALARM OUT SETUP

OUT1   : ALARM
OUT2   : 1 MIN
EXIT(ESC TO EXIT)
```

You press the **CTRL** or **IRIS Open** key then that alarm out operates during the setting time only.

• SYSTEM INFORMATION

```
SYSTEM I NFORMATION

CAMERA TYPE       : xxxx-Vx. xx
H/W VERSION      : Vx. xx-xxxx
ROM VERSION       : Vx. xxxxxx
PROTOCOL          : xxxx
BAUDRATE          : 9600(NONE)

HD B/D VERSION   : Vx. xx

EXIT(ESC TO EXIT)
```

The system information provides essential information about the dome camera if service is required. This screen displays the camera type and ROM version. The information on this screen cannot be modified.

Appendix A — Specifications

20x Full-HD Mini-PTZ HD-TVI & AHD CAMERA

Model		20x
IMAGE		
Lens		20x 4.7mm ~ 94.0mm
Angle of View		55.5° (H) ~ 3.0° (H)
Image Sensor	Type	1/2.8" SONY STARVIS CMOS sensor
	Pixels	1945 (H) x 1109 (V)
Min. Illumination		Color : 0.35 Lux @ 50IRE BW : 0.013 Lux @ 50IRE
Scanning Mode		Progressive Scan
Wide Dynamic Range		True WDR
Day and Night Mode		True D/N (Auto, Day, Night)
Noise Reduction		2DNR, 3DNR
Digital Zoom		16x
Exposure Control		Auto, Manual, Shutter Priority, Iris Priority
White Balance Control		Auto, Manual, Incandescent, Fluorescent, Outdoor
Back Light Compensation		Yes
Image Effect		Flip (Digital)
Shutter Speed		25/30fps : Auto (1/30,000 ~ x8 sec.), Manual 50/60fps : Auto (1/50,000 ~ x8 sec.), Manual
VIDEO		
Resolution		HD-TVI : 1080p @ 25/30fps, 720p @ 25/30/50/60fps AHD : 1080p @ 25/30fps
Video Output		HD-TVI or AHD, Composite
DIS		Yes
Defog		Yes
PTZ Function		
Pan Range		360° Endless
Pan Speed		Max. 380°/sec. (Preset)
Tilt Range		-10° ~ 190°
Tilt Speed		Max. 380°/sec. (Preset)
Auto Calibration		0.1° ~ 6°
Auto Scan		1 Auto Pan & 16 Auto Scans
Preset		240
Tour		8
Pattern		8
Home Function		Yes
Privacy Mask Zone		8 Programmable Zones
EXTERNAL IN/OUT		
Video HD-TVI/AHD Output		BNC Jack
Video Composite Output		BNC Jack
Alarm		4 Inputs, 2 Outputs (Terminal Block)
Control		RS-485, Baud Rate: 2400 ~ 38400 bps (Default: 9600 bps)
ID (Camera Address)		1 ~ 3999

ETC	
Operating Humidity	0 ~ 90%RH (Non-condensing)
Operating Temperature	-10°C ~ 50°C
Operating Temperature (with Heater)	-30°C ~ 50°C
Power Supply	12VDC, 24VAC
Power Supply (with Heater)	24VAC
Power Consumption	1.0A (12.0W) @ 12VDC or 24VAC
Power Consumption (with Heater)	1.5A (22.0W) @ 24VAC
Dimensions	See dimension
Net Weight	Approx. 1.6kg
Ingress Protection	IP66

* Specifications are subject to change without notice *

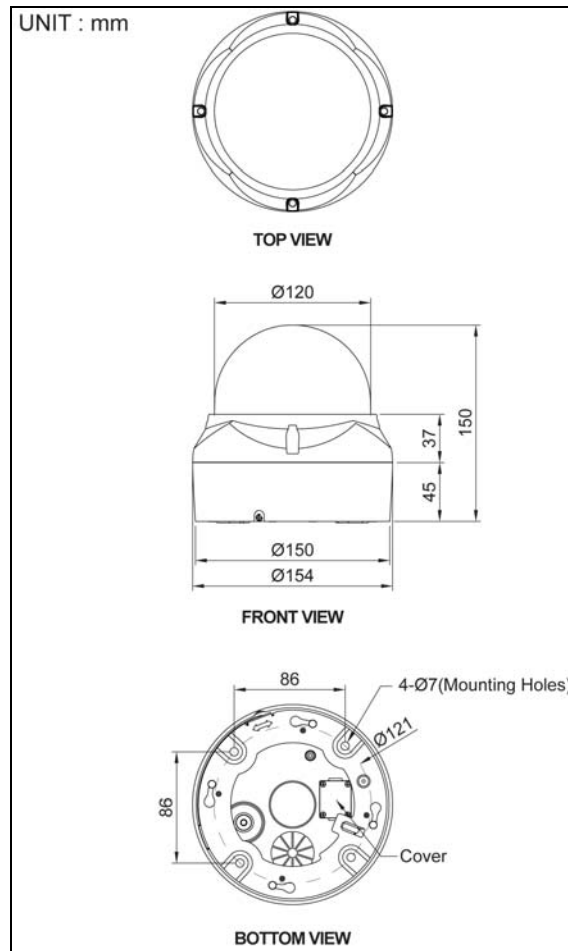

Figure – Dimension

Appendix B — Troubleshooting

If problems occur, verify the installation of the camera with the instructions in this manual and with other operating equipment. Isolate the problem to the specific piece of equipment in the system and refer to the equipment manual for further information.

Problem	Possible Solution
No video.	Verify that power is connected to all pieces of equipment in the system. Verify that the power switches are in the ON position. Check the video connections.
Poor video quality.	Check that the BNC connectors are inserted properly. Check the voltage level of the dome camera. Cable for video is shielded.
Dome cameras lose their positions.	Reset the cameras using the Dome configuration menus. Check that the dome cameras are inserted properly in the base. Check the voltage level of the dome camera.
Camera number does not match the multiplexer number.	Check the camera ID and insert the BNC cable into the proper input of the multiplexer.



20x Full-HD Mini-PTZ HD-TVI & AHD CAMERA



50303980A