

Network Video Recorder

Quick Guide

CSP-10SVR256

Version 1.0.2

Before reading this manual

This manual contains basic instructions on installing and using CSP-10SVR256 Network Video Recorder. Users who are using this product for the first time, as well as users with experience using comparable products, must read this manual carefully before use and heed to the warnings and precautions contained herein while using the product. Safety warnings and precautions contained in this manual are intended to promote proper use of the product and thereby prevent accidents and property damage and must be followed at all times.

Once you have read this manual, keep it at an easily accessible location for future reference.

- The manufacturer will not be held responsible for any product damage resulting from the use of unauthorized parts and accessories or from the user's failure to comply with the instructions contained in this manual.
- It is recommended that first-time users of Costar Network Video Recorder and individuals who are not familiar with its use seek technical assistance from their retailer regarding product installation and use.
- If you need to disassemble the product for functionality expansion or repair purposes, you must contact your retailer and seek professional assistance.

Safety, Environmental, and Regulatory Information

Refer to the **Safety, Environmental, and Regulatory Information** document included in the product package.

Copyright

© 2020 Costar Video Systems

Costar Video Systems reserves all rights concerning this manual.

Use or duplication of this manual in part or whole without the prior consent of Costar Video Systems is strictly prohibited.

Contents of this manual are subject to change without prior notice..

Registered Trademarks

Costar is a registered trademark of Costar Video Systems

Other company and product names are registered trademarks of their respective owners.

Table of Contents

1	Introduction.....	4
2	Accessories	5
3	Overview.....	6
3.1	Dimension.....	6
3.2	Front Panel.....	6
3.3	Rear Panel.....	11
3.4	Front Bezel	13
4	Getting Started.....	14
4.1	Setting Windows OS.....	14
4.2	Setting Built-in SSD Storages	16
4.3	Setting Recording Drives.....	17
4.4	StarNET Pro.....	33
4.5	Teaming Network Interface Controller(NIC)	34
5	Licenses and Service Codes.....	40
5.1	Windows OS License	40
5.2	StarNET Pro License.....	41
5.3	Service Tag or Express Service Code.....	41
6	Specification	42
7	Warranty	44

1 Introduction

This is a video recorder that supports surveillance, recording, and playback of video from network cameras or video encoders.

This NVR (Network Video Recorder) unit offers the following features:

- Tested and validated with StarNET Pro up to 256 Full HD H.264/H.265 IP cameras
- Supports up to 256 Full HD cameras in real-time for enterprise-level surveillance systems
- 1,024Mbps (128MBps) maximum recording bandwidth per server
- Redundancy of power for mission-critical reliability
- Complete compatibility with Costar components: IP cameras, analog DVR, Et TVI, DirectNET NVR, and encoders
- Equipped with RAID 5, RAID 6 recording, Hot swappable
- 2U rack mount chassis with sliding rails and cable management arm for ease of serviceability
- Supports H.264, H.265 compression, and Intelligent Codec
- Supports Onvif Profile S, Axis, Panasonic, etc.

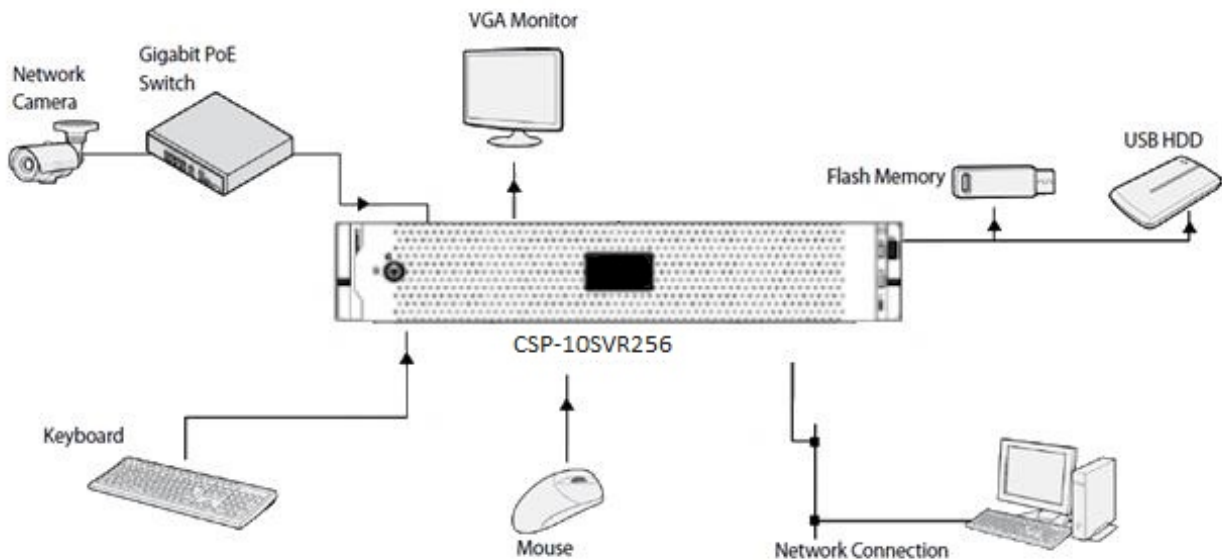

2 Accessories

Upon unpackaging the product, check the contents inside to ensure that all the following accessories are included.



No.	Component	Quantity
1	CSP-10SVR256 Main Body	1
2	Front Chassis & Lock Key	1
3	Safety, Environmental, and Regulatory Information Manual	1
4	Power Code (A Type- Deskside)	2
5	Power Jumper Code (10A,4M,C13/C14)	2
6	Rack Mounting Bracket	1
7	Rack Installation Instructions Manual	1
8	Cable Strap	2 (1 pack)

3 Overview

3.1 Dimension

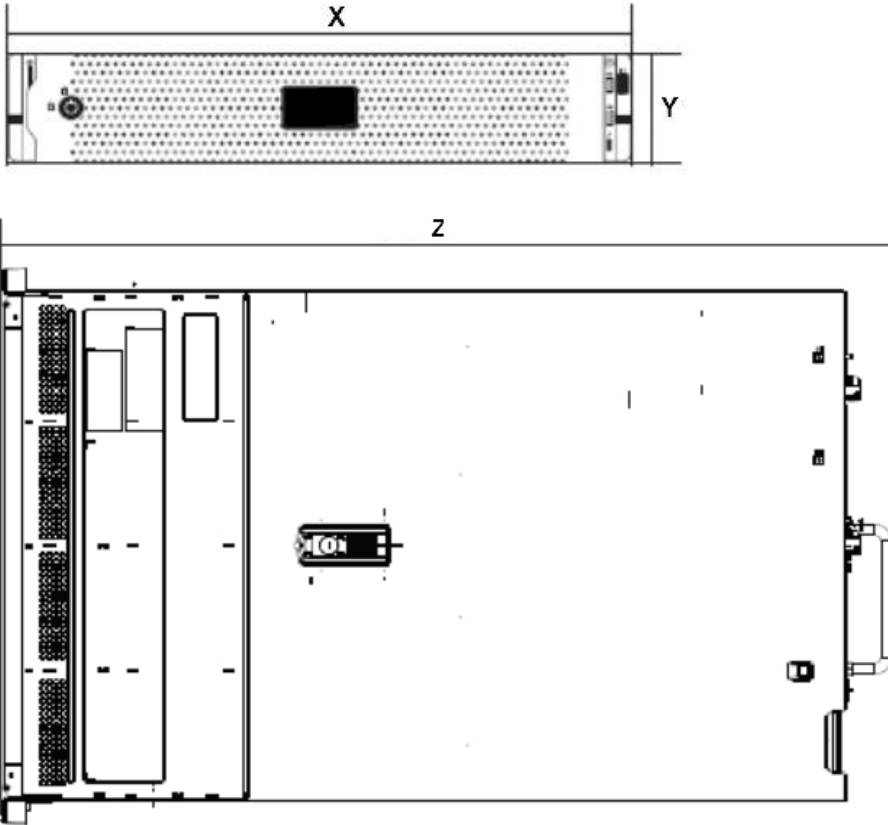

X	Y	Z
482.0 mm (18.98 inch)	86.8 mm (3.42 inch)	717.6 mm (28.25 inch)

3.2 Front Panel



Item	Component	Description
1	Left control panel	Contains system health and system ID, status LED and optional iDRAC Quick Sync 2 (wireless).
2	Drive slots	Enable you to install up to 8 drives that are supported on your system.
3	Right control panel	Contains the power button, VGA port, iDRAC Direct micro USB port, and two USB 2.0 ports.

3.2.1 Left control panel

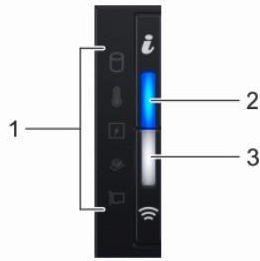

Item	Indicator	Icon	Description
1	Status LED	N/A	Indicate the status of the system. The indicators display solid amber if any error occurs. For more information, see Status LED indicators .
2	System health and ID		Indicates the system health. For more information, see System Health and System ID indicator .
3	iDRAC Quick Sync 2 wireless indicator		Indicates if the iDRAC Quick Sync 2 wireless option is activated. The Quick Sync 2 feature allows management of the system using mobile devices. This feature aggregates hardware/firmware inventory and various system level diagnostic/error information that can be used in troubleshooting the system. For more information, see iDRAC Quick Sync 2 indicator .

(1) Status LED Indicators

Icon	Indicator	Condition	Corrective Action
	Drive	The indicator turns solid amber if there is a drive error.	<ul style="list-style-type: none"> Check the System Event Log to determine if the drive has an error. If the drives are configured in a RAID array, restart the system, and enter the host adapter configuration utility program.
	Temperature	The indicator turns solid amber if the system experiences a thermal error.	Ensure that none of the following conditions exist: <ul style="list-style-type: none"> A cooling fan has been removed or has failed. System cover, air shroud, memory module blank, or back filler bracket is removed. Ambient temperature is too high. External airflow is obstructed.
	Electrical	The indicator turns solid amber if the system experiences an electrical error (for example, voltage out of range, or a failed power supply unit (PSU) or voltage regulator).	Check the System Event Log or system messages for the specific issue. If it is due to a problem with the PSU, check the LED on the PSU. Reseat the PSU.
	Memory	The indicator turns solid amber if a memory error occurs.	Check the System Event Log or system messages for the location of the failed memory. Reseat the memory module.

	PCIe	The indicator turns solid amber if a PCIe card experiences an error.	Restart the system. Update any required drivers for the PCIe card. Reinstall the card.
---	------	--	--

(2) System Health and System ID indicator

Indicator code	Condition
Solid blue	Indicates that the system is turned on, system is healthy, and system ID mode is not active. Press the system health and system ID button to switch to system ID mode.
Blinking blue	Indicates that the system ID mode is active. Press the system health and system ID button to switch to system health mode.
Solid amber	Indicates that the system is in fail-safe mode.
Blinking amber	Indicates that the system is experiencing a fault. Check the System Event Log for specific error messages.

(3) iDRAC Quick Sync 2 indicator

Indicator code	Condition	Corrective Action
Off (default state)	Indicates that the iDRAC Quick Sync 2 feature is turned off.	<ul style="list-style-type: none"> Press the iDRAC Quick Sync 2 button to turn on the iDRAC Quick Sync 2 feature. If the LED fails to turn on, reseal the left control panel flex cable and check.
Solid white	Indicates that iDRAC Quick Sync 2 is ready to communicate.	<ul style="list-style-type: none"> Press the iDRAC Quick Sync 2 button to turn off. If the LED fails to turn off, restart the system.
Blinks white rapidly	Indicates data transfer activity.	If the indicator continues to blink indefinitely, contact the installer or seller.
Blinks white slowly	Indicates that firmware update is in progress.	If the indicator continues to blink indefinitely, contact the installer or seller.
Blinks white five times rapidly and then turns off	Indicates that the iDRAC Quick Sync 2 feature is disabled.	Check if iDRAC Quick Sync 2 feature is configured to be disabled by iDRAC.
Solid amber	Indicates that the system is in fail-safe mode.	Restart the system.
Blinking amber	Indicates that the iDRAC Quick Sync 2 hardware is not responding properly.	Restart the system.

3.2.2 Drive slots

Each drive carrier has an activity LED indicator and a status LED indicator.

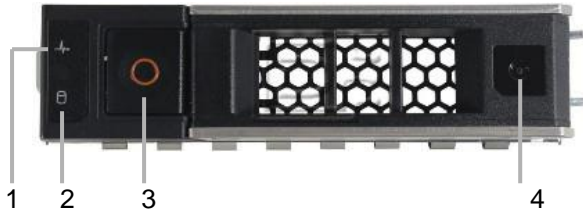

Item	Component	Icon	Description
1	Drive status indicator		Indicates the power condition of the drive.
2	Drive activity indicator		Indicates whether the hard drive is currently in use or not.
3	Drive release button	N/A	Press the button to open the drive carrier release handle to remove or replace the drive.
4	Drive information tag	N/A	Shows the drive information such as capacity, drive type, rpm and so on.





(1) Drive status indicator code

Indicator code	Condition
Flashes green twice per second	Identifying drive or preparing for removal.
Off	Drive ready for removal. NOTE: The drive status indicator remains off until all drives are initialized after the system is turned on. Drives are not ready for removal during this time.
Flashes green, amber, and then turns off	Predicted drive failure.
Flashes amber four times per second	Drive failed.
Flashes green slowly	Drive rebuilding.
Solid green	Drive online.
Flashes green for three seconds, amber for three seconds, and then turns off after six seconds	Rebuild stopped.

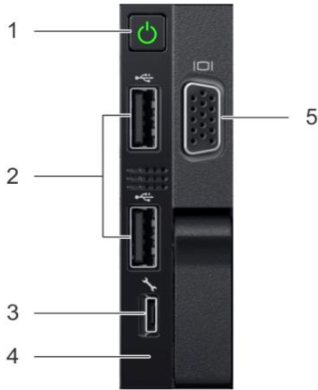
NOTE: If the drive is in the Advanced Host Controller Interface (AHCI) mode, the status LED indicator does not turn on.

3.2.3 Right control panel



Item	Indicator	Icon	Description
1	Power button		Indicates if the system is turned on or off. Press the power button to manually turn on or off the system.
2	USB port (2)		The USB ports are 4-pin, 2.0-compliant. These ports enable you to connect USB devices to the system.
3	iDRAC Direct port		Indicates if the iDRAC Quick Sync 2 wireless option is activated. The Quick Sync 2 feature allows management of the system using mobile devices. This feature aggregates hardware/firmware inventory and various system level diagnostic/error information that can be used in troubleshooting the system.
4	iDRAC Direct LED	N/A	The iDRAC Direct LED indicator lights up to indicate that the iDRAC Direct port is connected. For more information, see iDRAC Direct LED indicator .
5	VGA port		Enables you to connect a display device to the system.

(1) iDRAC Direct LED indicator

Indicator code	Condition
Solid green for two seconds	Indicates that the laptop or tablet is connected.
Flashing green (on for two seconds and off for two seconds)	Indicates that the laptop or tablet connected is recognized.
Turns off	Indicates that the laptop or tablet is unplugged.

3.3 Rear Panel

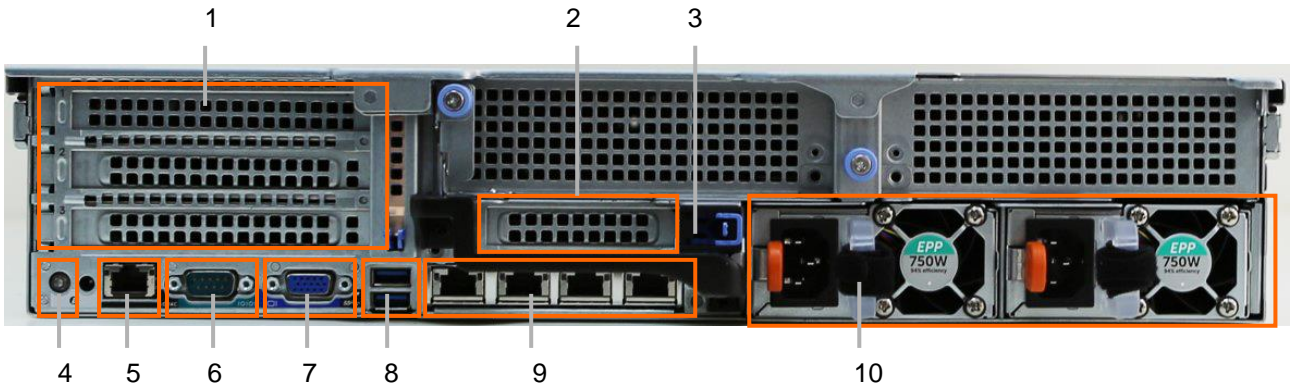

Item	Component	Icon	Description
1	Full-height PCIe expansion card slot	N/A	The PCIe expansion card slot (riser 1) connects up to three full-height PCIe expansion cards to the system.
2	Half-height PCIe expansion card slot	N/A	The PCIe expansion card slot (riser 2) connects one half-height PCIe expansion cards to the system.
3	Rear handle	N/A	The rear handle can be removed to enable any external cabling of PCIe cards that are installed in the PCIe expansion card slot
4	System identification button		The System Identification (ID) button is available on the front and back of the systems. Press the button to identify a system in a rack by turning on the system ID button. You can also use the system ID button to reset iDRAC and to access BIOS using the step through mode.
5	iDRAC dedicated port		Enables you to remotely access iDRAC.
6	Serial port		Enables you to connect a serial device to the system.
7	VGA port		Enables you to connect a display device to the system.
8	USB port		The USB ports are 9-pin and 3.0-compliant. These ports enable you to connect USB devices to the system.
9	NIC port		The NIC ports that are integrated on the network daughter card (NDC) provide network connectivity.
10	Power supply unit	N/A	Supplies power to the system.

(1) NIC indicator



Item	Component	Description
1	Link LED indicator	Indicates the speed of the connected network.
2	Activity LED indicator	Indicates if data is flowing through the NIC.

Indicator code	Condition
Link and activity indicators are off	The NIC is not connected to the network.
Link indicator is green and activity indicator is blinking green	The NIC is connected to a valid network at its maximum port speed and data is being sent or received.

(2) Power Supply Unit (PSU) indicator

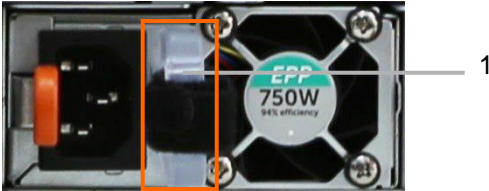

Item	Component	Description
1	AC PSU status indicator	Shows whether power is present or if a power fault has occurred.

Indicator code	Condition
Green	A valid power source is connected to the PSU and the PSU is operational.
Blinking amber	Indicates a problem with the PSU.
Not illuminated	Power is not connected to the PSU.
Blinking green	When the firmware of the PSU is being updated, the PSU handle blinks green. CAUTION: Do not disconnect the power cord or unplug the PSU when updating firmware. If firmware update is interrupted, the PSUs do not function.
Blinking green and turns off	When hot-plugging a PSU, the PSU handle blinks green five times at a rate of 4 Hz and turns off. This indicates a PSU mismatch with respect to efficiency, feature set, health status, or supported voltage. CAUTION: If two PSUs are installed, both the PSUs must have the same type of label; for example, Extended Power Performance (EPP) label. Mixing PSUs from previous generations of PowerEdge servers is not supported, even if the PSUs have the same power rating. This results in a PSU mismatch condition or failure to turn the system on. CAUTION: When correcting a PSU mismatch, replace only the PSU with the blinking indicator. Swapping the PSU to make a matched pair can result in an error condition and unexpected system shutdown. To change from a high output configuration to a low output configuration or vice versa, you must turn off the system. CAUTION: AC PSUs support both 240 V and 120 V input voltages with the exception of Titanium PSUs, which support only 240 V. When two identical PSUs receive different input voltages, they can output different wattages, and trigger a mismatch. CAUTION: If two PSUs are used, they must be of the same type and have the same maximum output power.

3.4 Front Bezel



A key is located at the backside of the front bezel. You can secure recording storages by locking the lock on the front side of the bezel.

4 Getting Started

4.1 Setting Windows OS

4.1.1 Setting password

Default login details for CSP-10SVR256 are as follows.

ID: **Administrator**

Password: **P@ssw0rd**

Log in with the login detail above, and make sure to change the password for security.

(1) Click 'Windows Setup > Control Panel > User Accounts > Manage another account'.

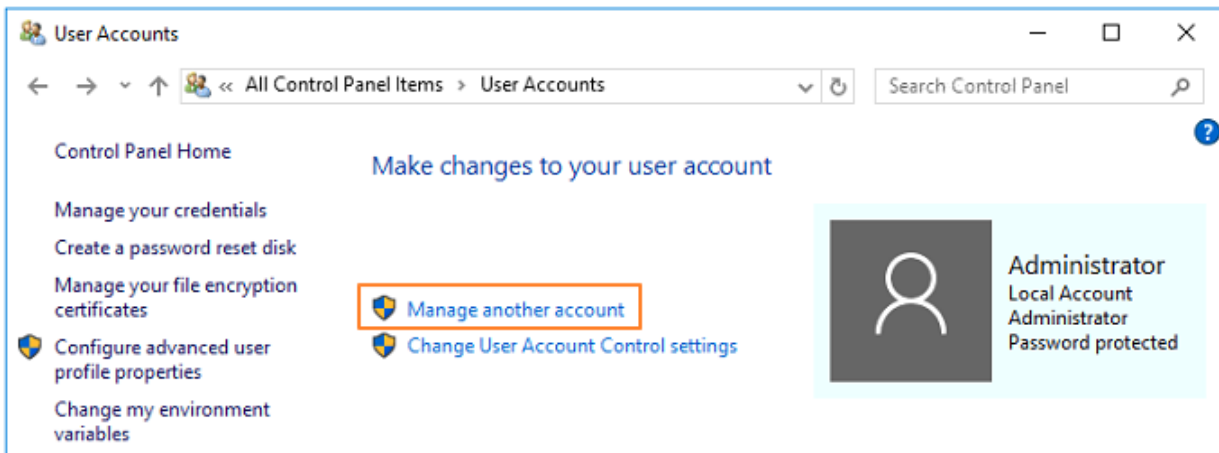

(2) Select Administrator account, then select 'Change the password' menu.

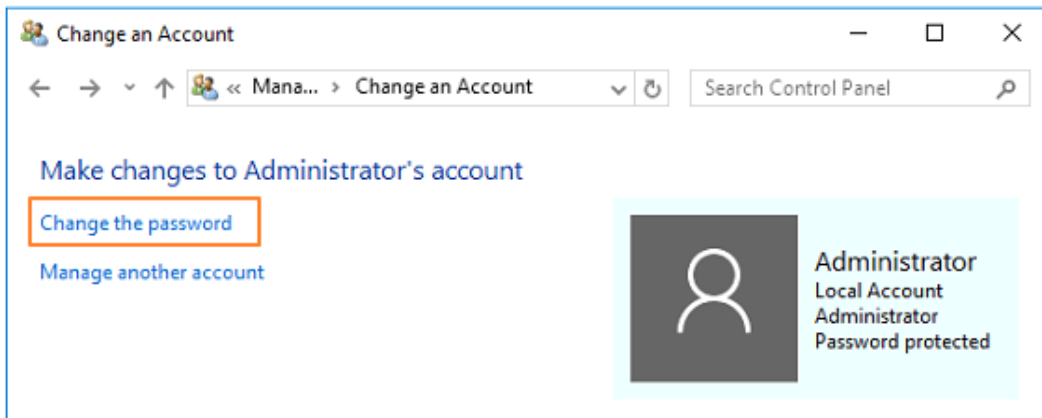

(3) Change password of Administrator account considering the following password rules.

- Be at least six characters in length
- Contain characters from three of the following four categories;
 - English uppercase letters (A through Z)
 - English lowercase letters (a through z)
 - Base 10 digit (0 through 9)
 - Non-alphabetic characters (!, @, #, \$, % &, *)

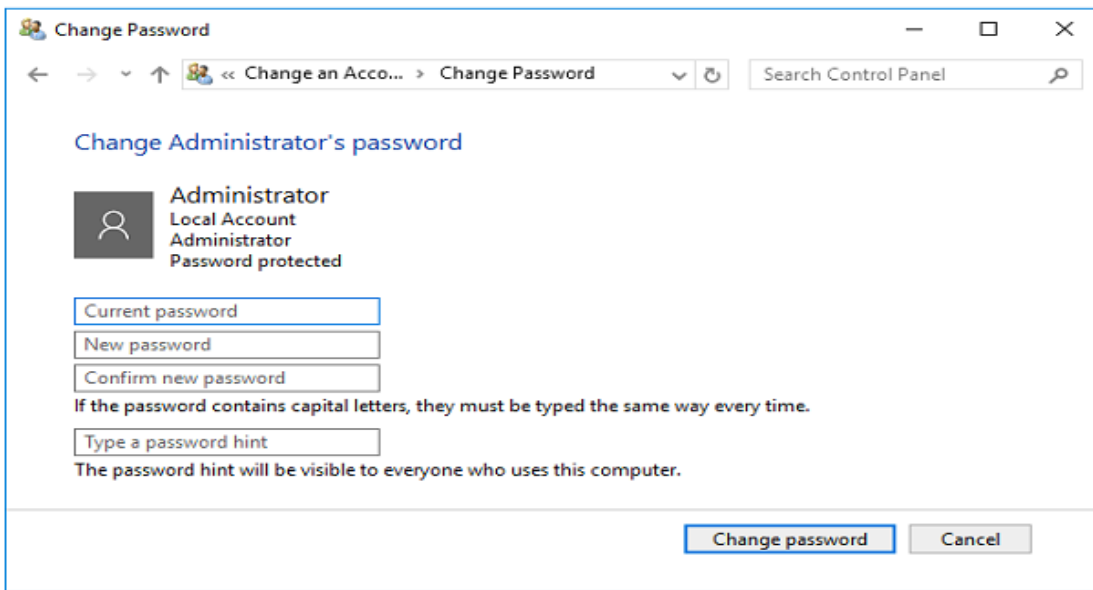

NOTE. It is recommended to create a **password reset disk** by clicking 'Windows Setup > Control Panel > User Accounts > Create a password reset disk' to reset a password when you forget the password of administrator or user account. A USB memory device or CD/DVD is needed to create a password reset disk.

4.1.2 Activating Windows OS license

Windows on the CSP-10SVR256 is basically activated when it is dispatched. Windows OS must be activated in the following picture. If your Windows OS is not activated, please refer to 'Checking Windows OS Key' and activate your Windows OS with your Windows OS Key.

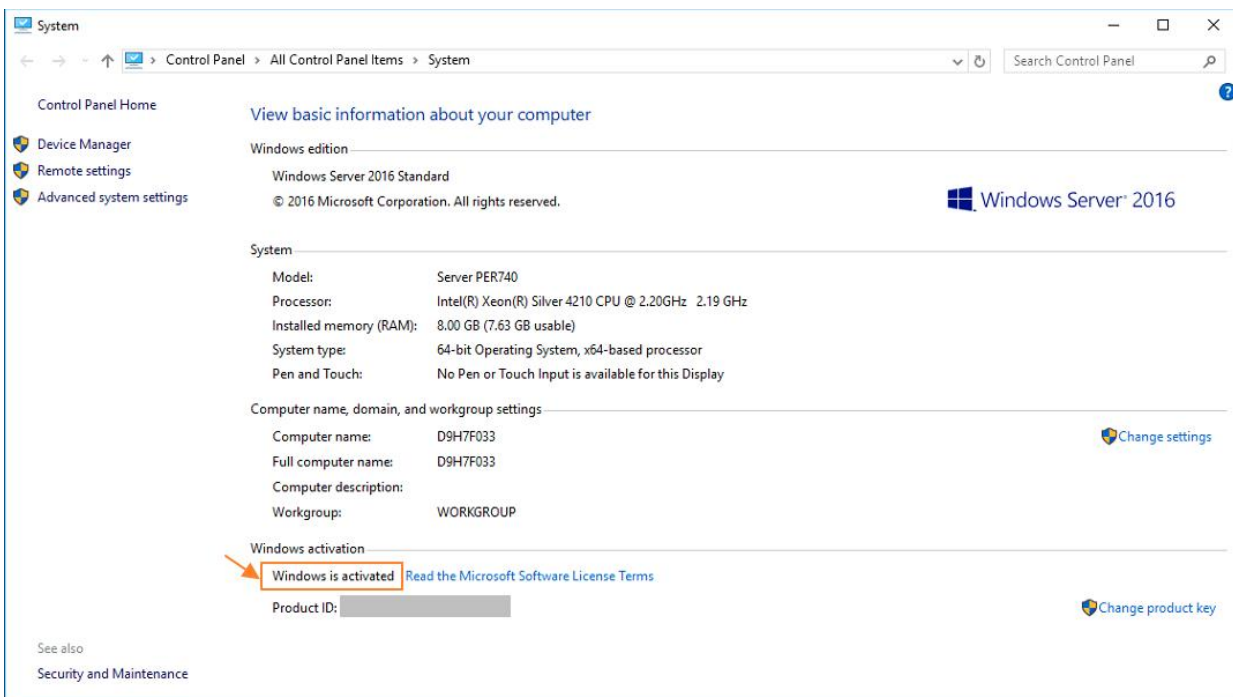

4.2 Setting Built-in SSD Storages

Two 240GB SSDs are located inside of CSP-10SVR256. Typically, the SSDs are on RAID 1 level which appears to be a single drive. Windows OS is installed on this StarNET Pro installation package is located on the same drive as well. This drive is used for software installation.

Checking the SSD status procedure is as follows.

On the Windows OS > Device Manager, check if 240GB SSD is recognized.

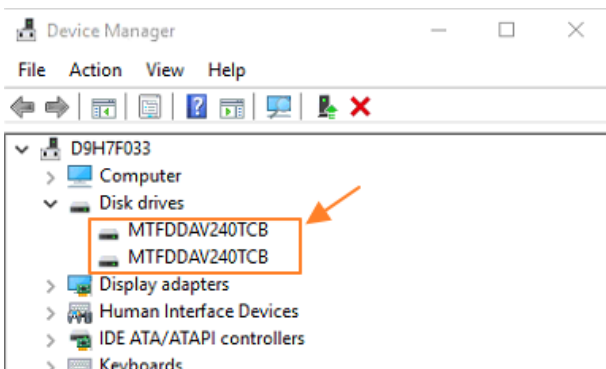

If you check 'Windows Setup > File Explorer > Device and drives', SSDs are available as a single Logical Disk (C:).

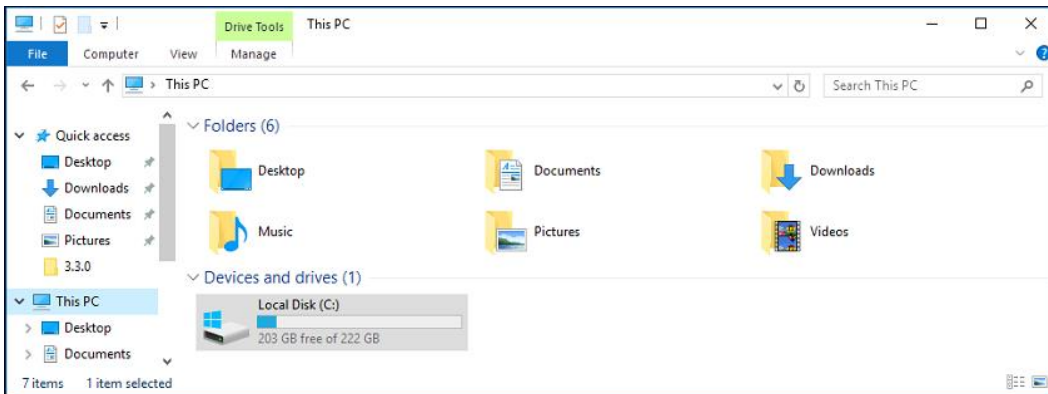

You can also see SSDs are configured as a single Logical Disk at 'Windows Setup > Disk Management' Disk.

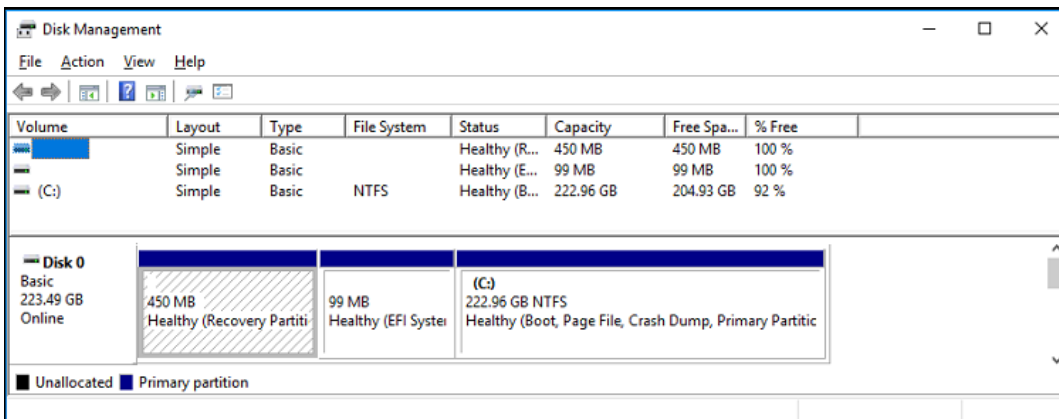

4.3 Setting Recording Drives

4.3.1 Installing Recording Drives

Maximum 8 of 3.5" HDD can be attached to the Drive slots of System..



Drives for recording purposes can be installed by the procedure below.

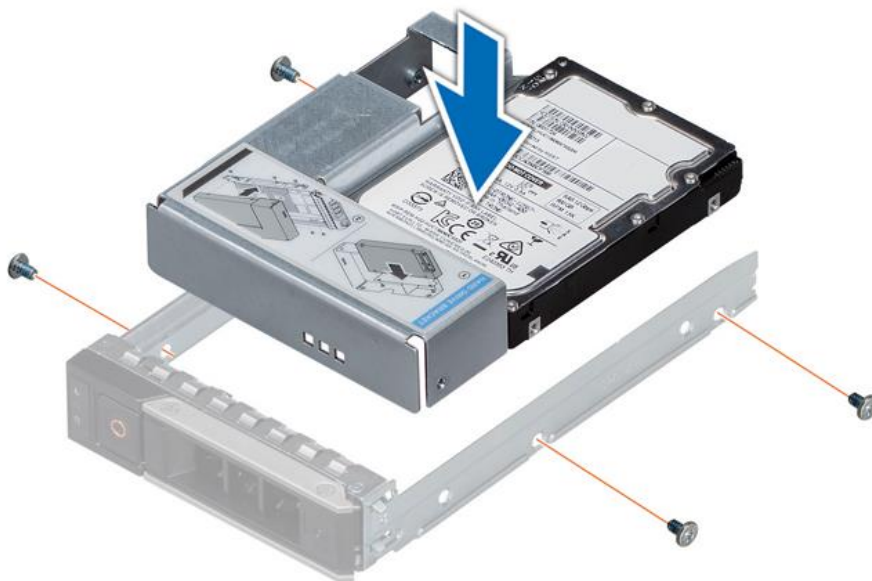

- (1) Insert the 3.5 inch drive adapter into the drive carrier with the connector end of the drive toward the back of the drive carrier.
- (2) Align the drive's screw holes with the holes on the drive carrier.
- (3) Install the screws to secure the drive to the drive carrier.

4.3.2 Configuring RAID

Configuring RAID for recording HDD can be done by entering System Setup menu from the boot up process.

- (1) Press F2 while system is booting up, then select 'Entering System Setup' from the BIOS configuration screen.



- (2) Select 'System Setup Main Menu > Device Settings'.

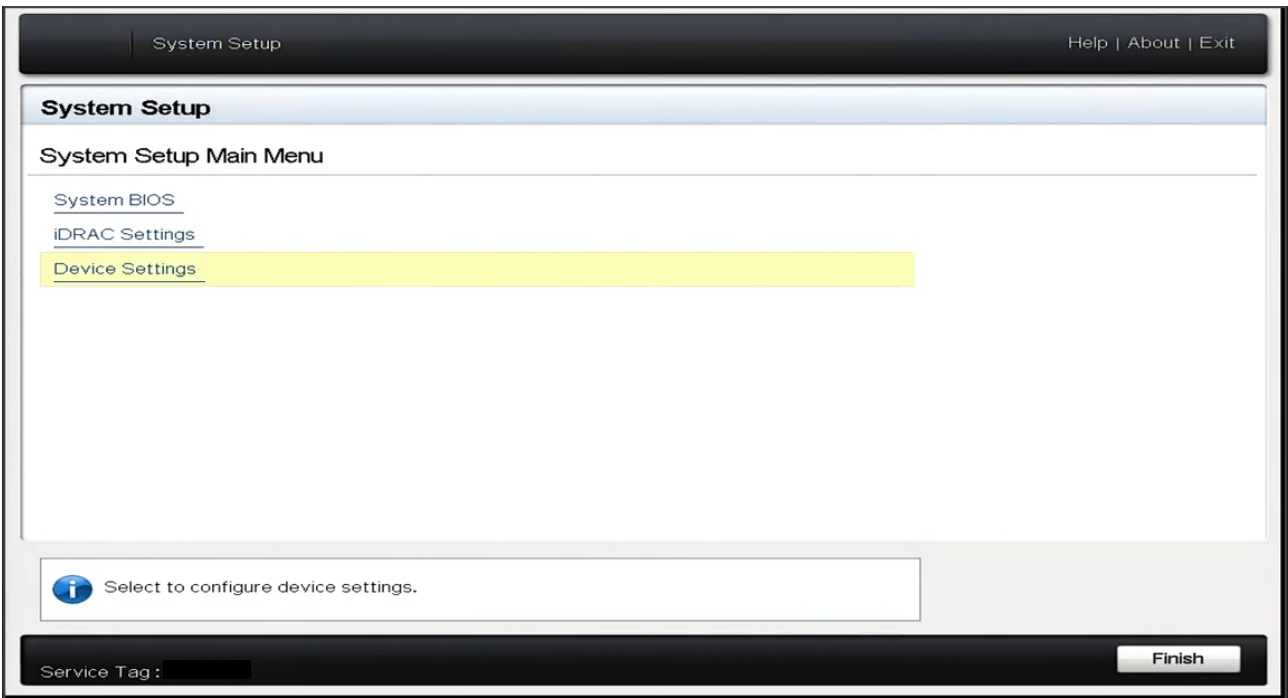

(3) Select 'Integrated RAID Controller 1:Dell <PERC H740 Mini> Configuration Utility'.

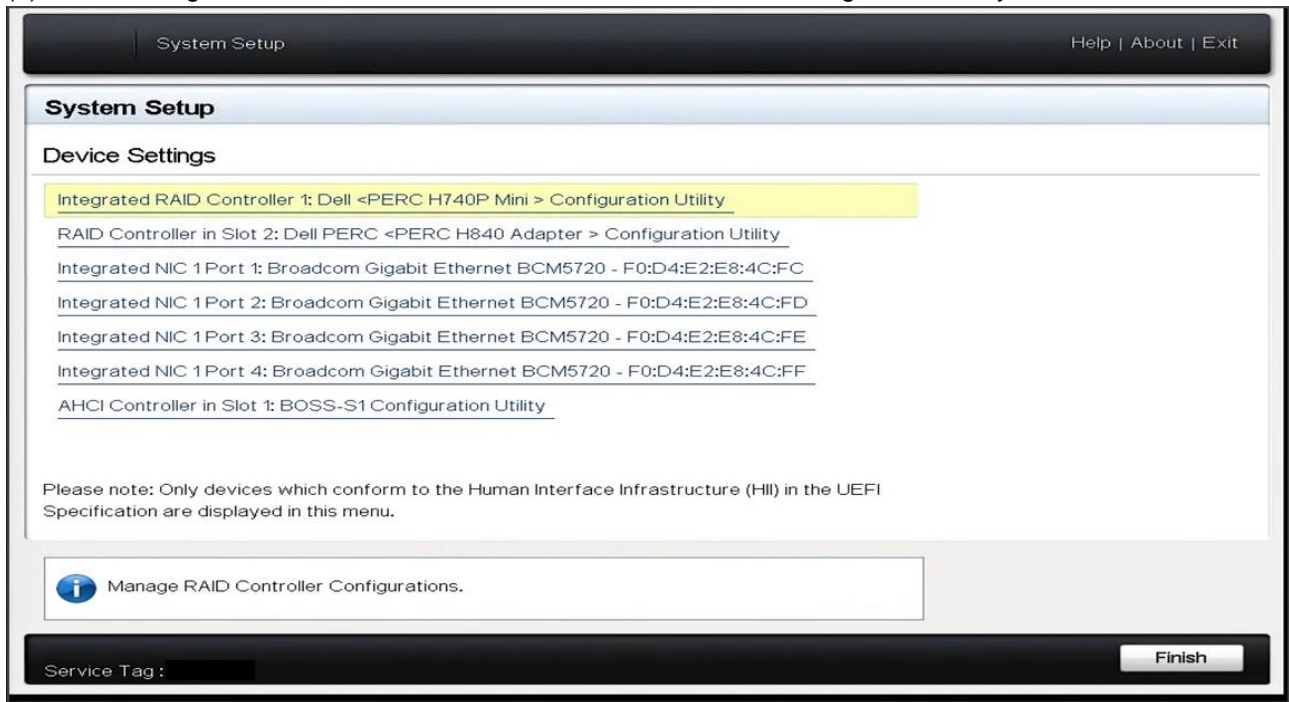

(4) Select 'Dashboard View > Main Menu'.

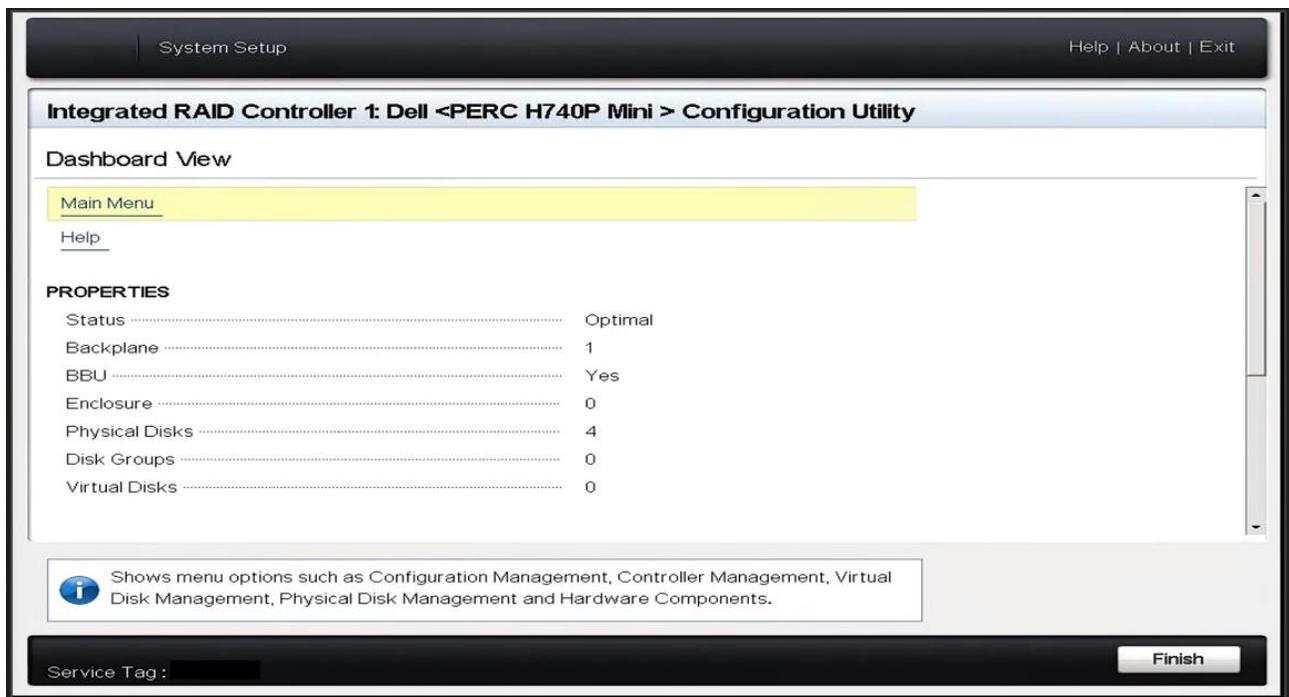

(5) Select 'Configuration Management > Create Virtual Disk'.

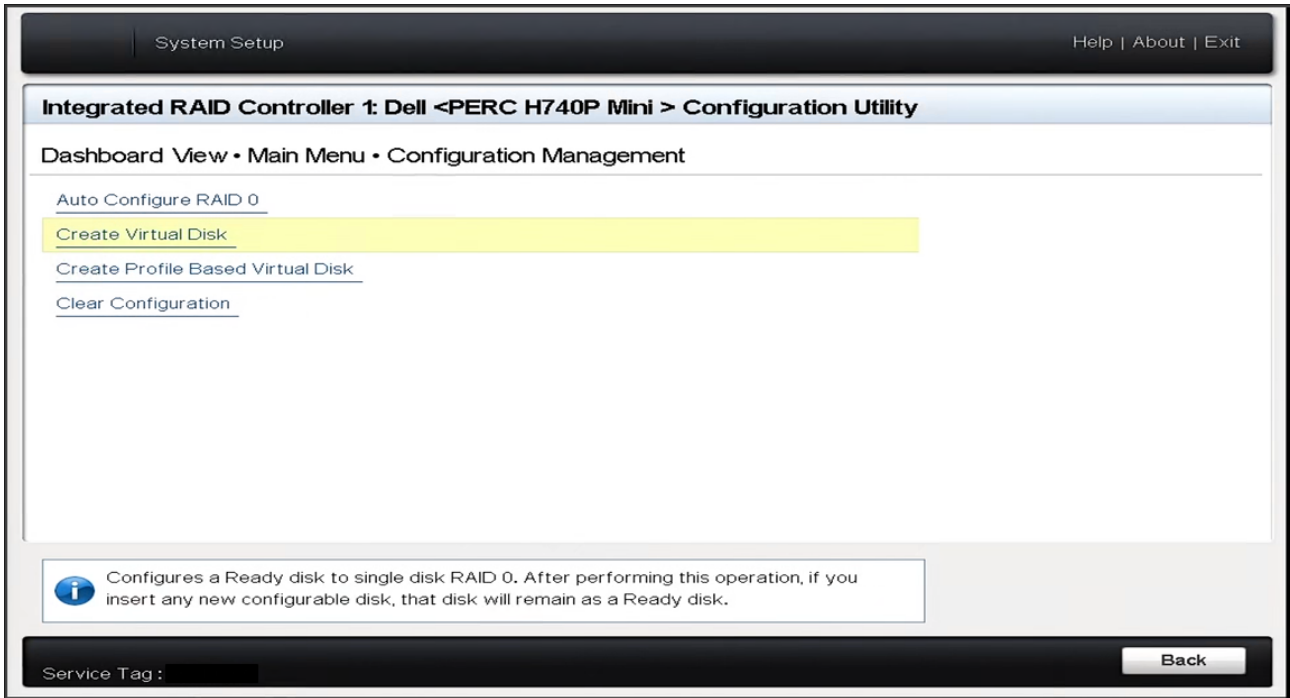

(6) Configure the main elements from 'Create Virtual Disk' menu.
- Select RAID Type.

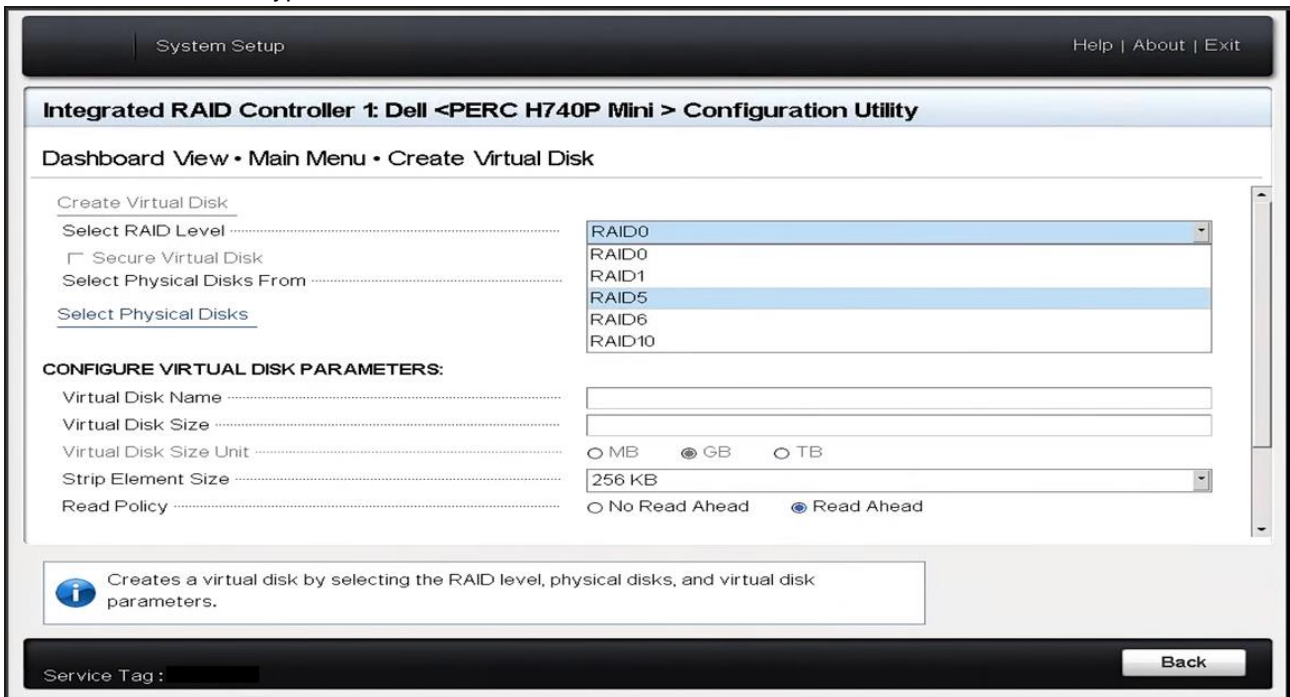

- You can select HDDs for your RAID level by ticking HDDs from 'Select Physical Disk'. After selecting the desired HDDs, press 'Apply Changes'.

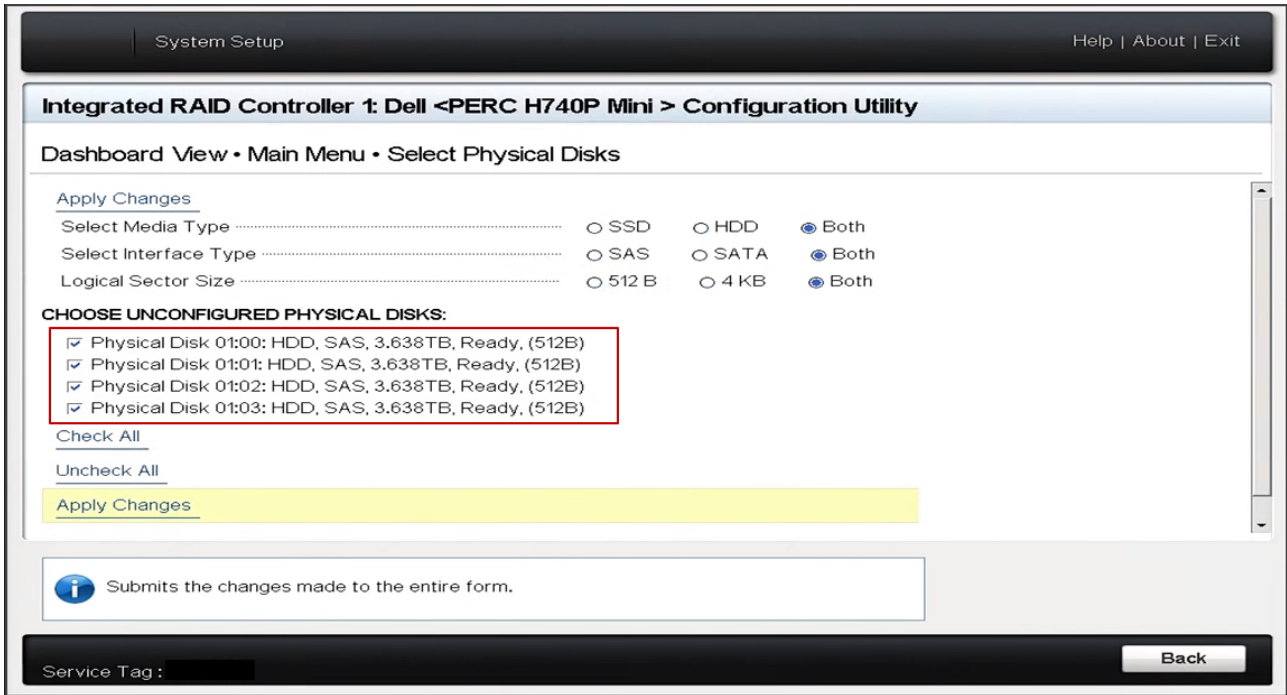

- Insert information of HDDs at 'Virtual Disk Name' and check if the Virtual Disk Size is correct.

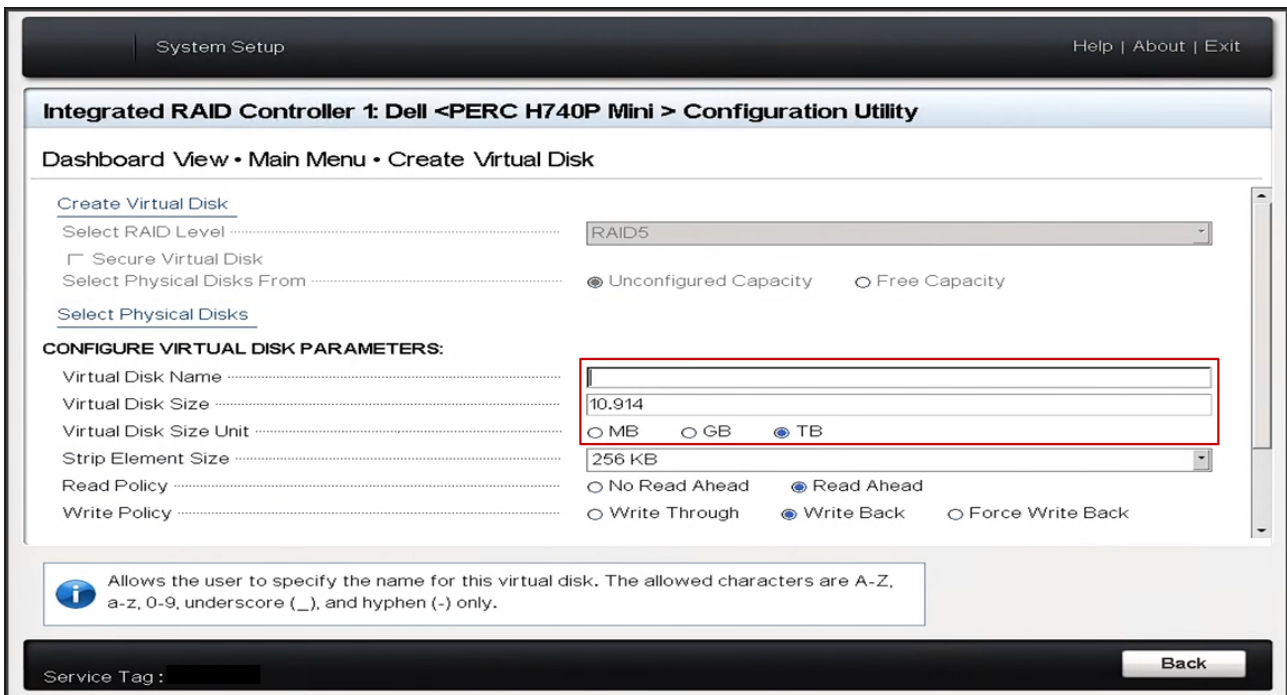

- After configuration, run 'Create Virtual Disk'.

The screenshot shows the 'Integrated RAID Controller 1: Dell <PERC H740P Mini > Configuration Utility' interface. At the top, it says 'System Setup' and 'Help | About | Exit'. Below the title bar, there are navigation links: 'Dashboard View • Main Menu • Create Virtual Disk'. The main area is titled 'CONFIGURE VIRTUAL DISK PARAMETERS:' and contains several settings: 'Virtual Disk Name' (RecDisk), 'Virtual Disk Size' (10.914), 'Virtual Disk Size Unit' (MB, GB, TB - TB is selected), 'Strip Element Size' (256 KB), 'Read Policy' (No Read Ahead, Read Ahead - Read Ahead is selected), 'Write Policy' (Write Through, Write Back, Force Write Back - Write Back is selected), 'Disk Cache' (Default, Enable, Disable - Default is selected), and 'Default Initialization' (No, Fast, Full - No is selected). A 'Create Virtual Disk' button is highlighted in yellow. Below the form, an information icon indicates that clicking the button submits changes and creates the virtual disk. At the bottom, there is a 'Service Tag' field and a 'Back' button.

The screenshot shows the 'Integrated RAID Controller 1: Dell <PERC H740P Mini > Configuration Utility' interface. At the top, it says 'System Setup' and 'About | Exit'. Below the title bar, there are navigation links: 'Dashboard View • Main Menu • Warning'. The main area contains a warning message: 'Creating Virtual Disks will cause the data on the associated Physical Disks to be permanently deleted.' Below this, it asks 'Are you sure you want to continue with this operation?'. There are two radio buttons: 'Confirm' (checked) and 'No'. The 'Confirm' option is highlighted in yellow. At the bottom, there is a 'Service Tag' field with the value '9H7F033'.

(7) Check the virtual disk is configured correctly at 'Main Menu > Virtual Disk Management' screen.

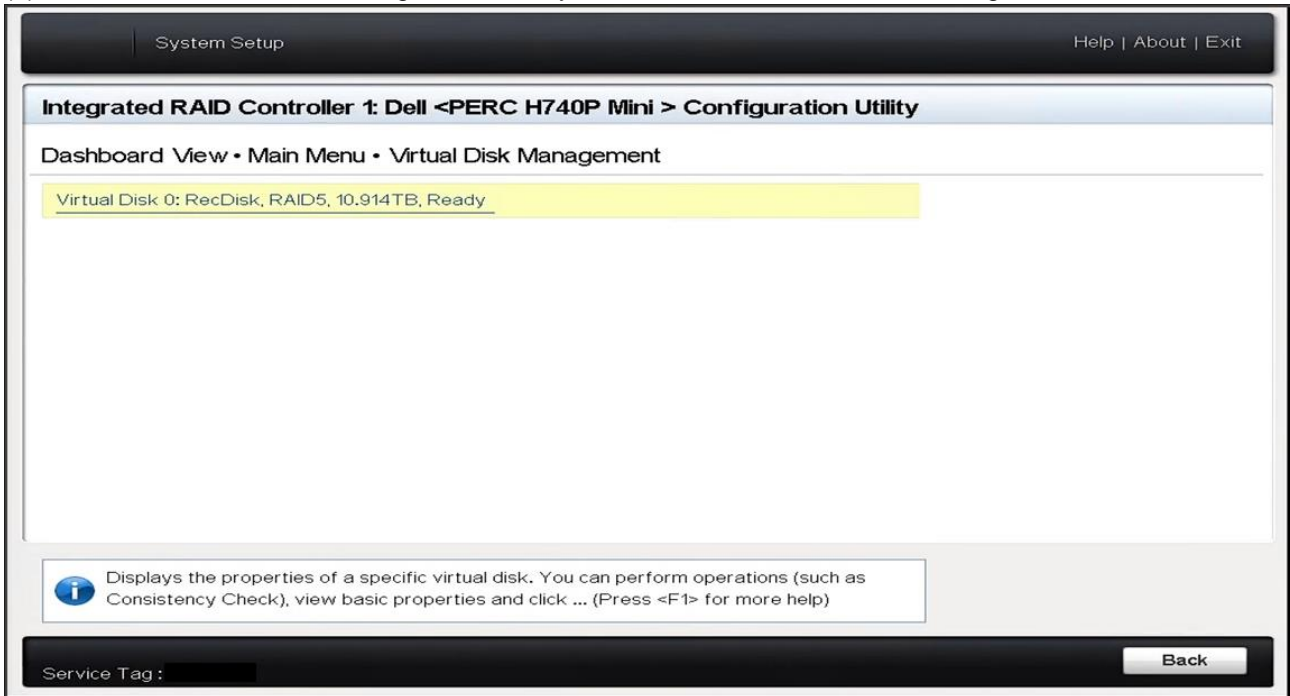

(8) Finish the 'System Setup' by clicking 'Finish' button at 'Main Menu'.

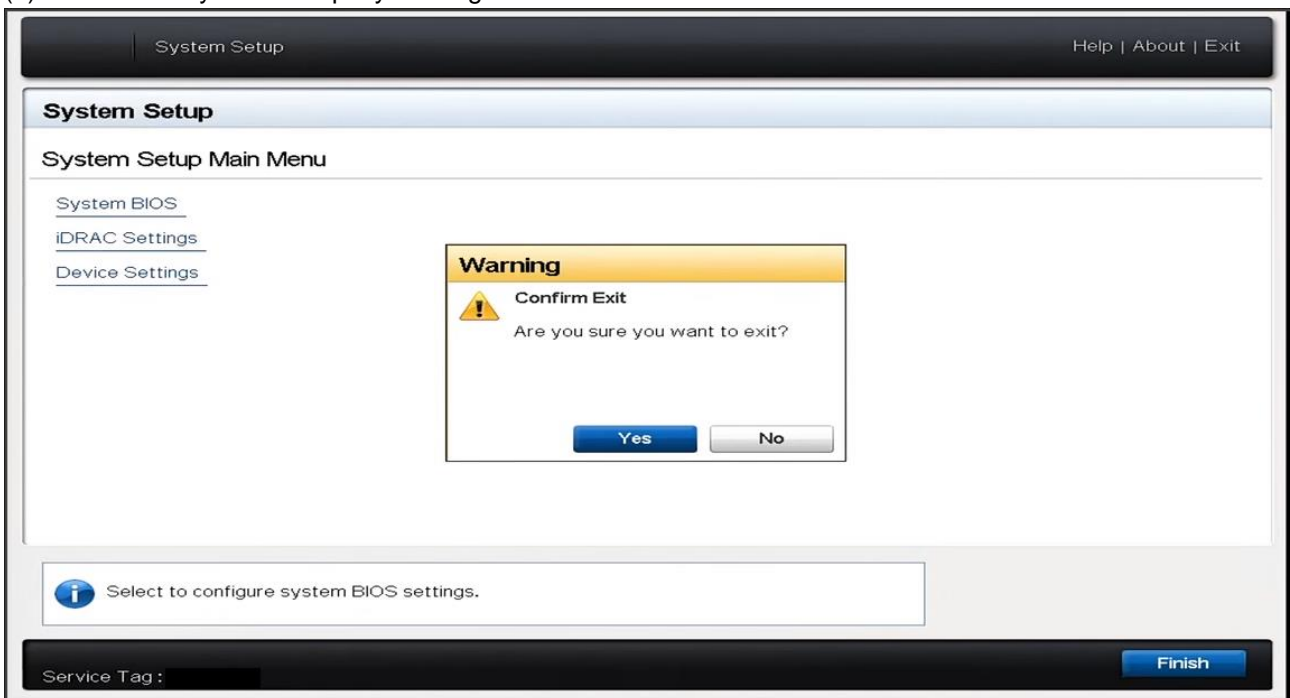

(9) After the Windows OS boot up, you can see the information on the newly created Virtual Disk at 'Windows Setup > Disk Management' menu.

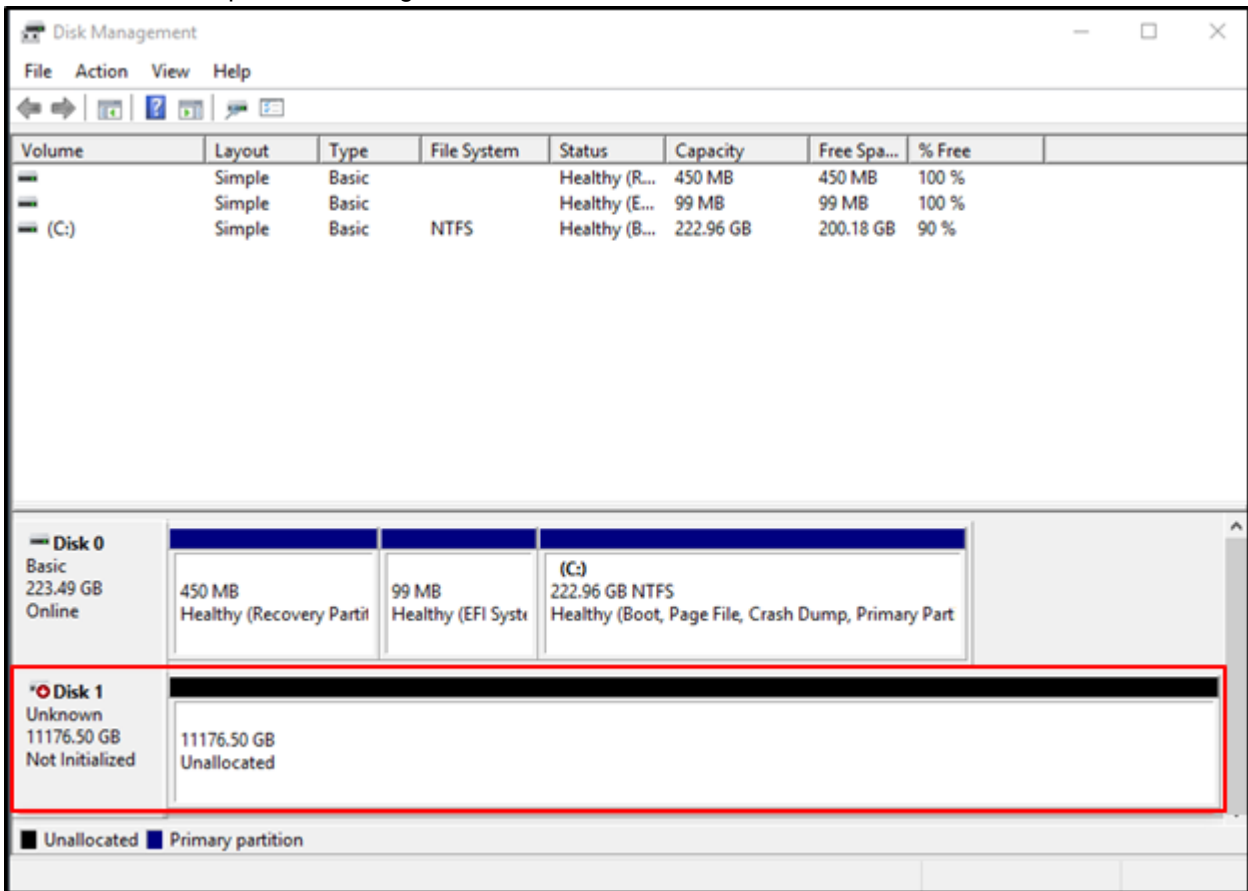

4.3.3 Connecting External Storages

To expand recording storage, an external storage such as CSP-10EXT-48TB can be used. To attach the external storage, PCIe type external storage controller card should be attached to IR-1100. To connect with CSP-10EXT-48TB, attaching 'PERP H840 Adapter' or similar Storage Controllers are recommended.

(1) To install a storage controller, turn off the device and open the top panel.



(2) You will see the inside of the device and the storage controller will be located where the red box is.



(4) Align the card-edge connector with the connector on the system board.

Press the card-edge down until the card is fully seated in the connector

(5) Connect the SAS data cable connectors to the card.

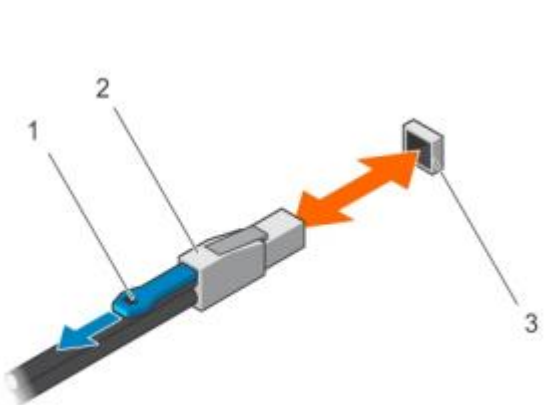

1: Pull-tab is used when you detach the cable

2: SAS cable

3: SAS port

(6) There are three ways to connect the external storage. For more information, please refer to the CSP-10EXT-48TB quick guide document. This document includes only one of the three ways as an example.

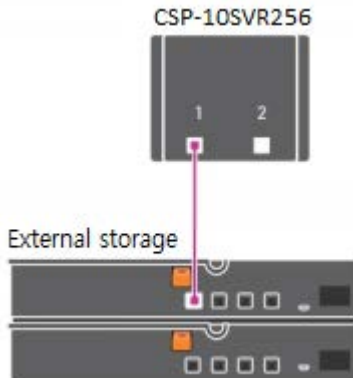

(7) Close the top panel.

(8) Reconnect the system to its electrical outlet, then turn on the system and any attached peripherals.

4.3.4 Configuring RAID for External Storages

Configuring RAID for external storages can be done by entering the System Setup menu from booting up process.

(1) Press F2 while system is booting up, select 'Entering System Setup' from BIOS configuration screen..



(2) Select 'System Setup Main Menu > Device Settings'.

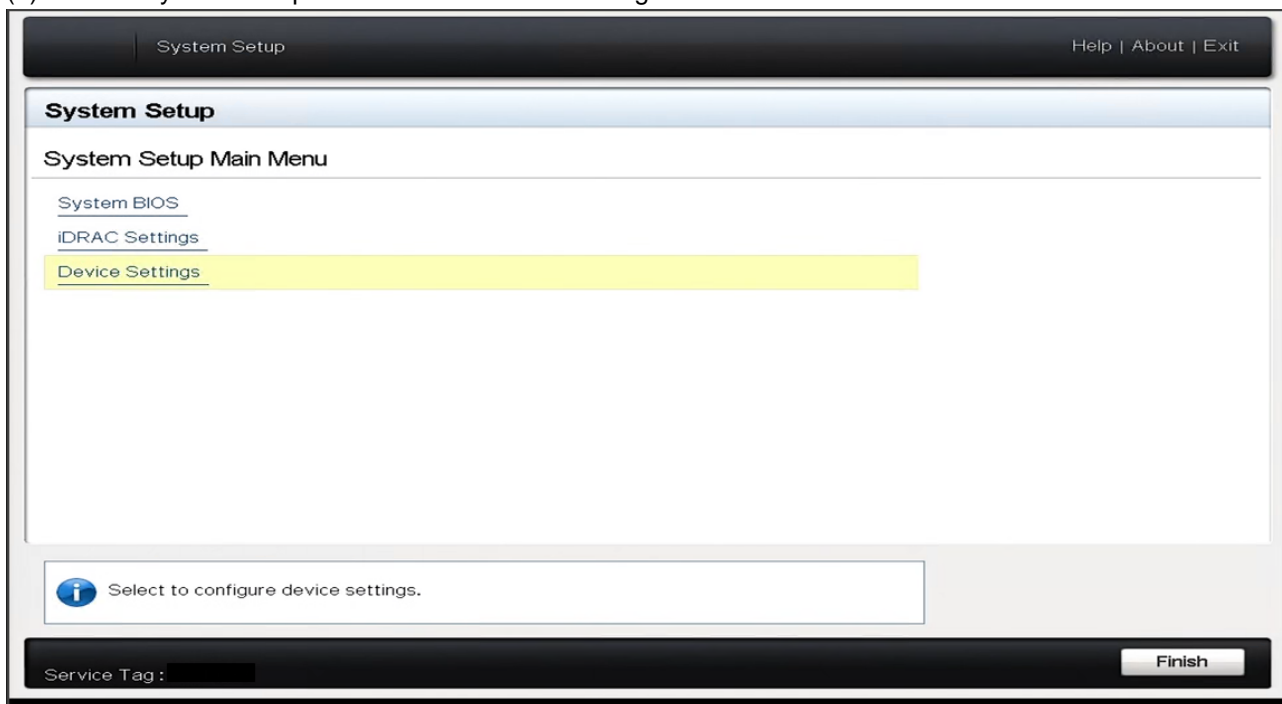

(3) Select 'RAID Controller in Slot 2:Dell PERC <PERC H840 Adapter > Configuration Utility'.

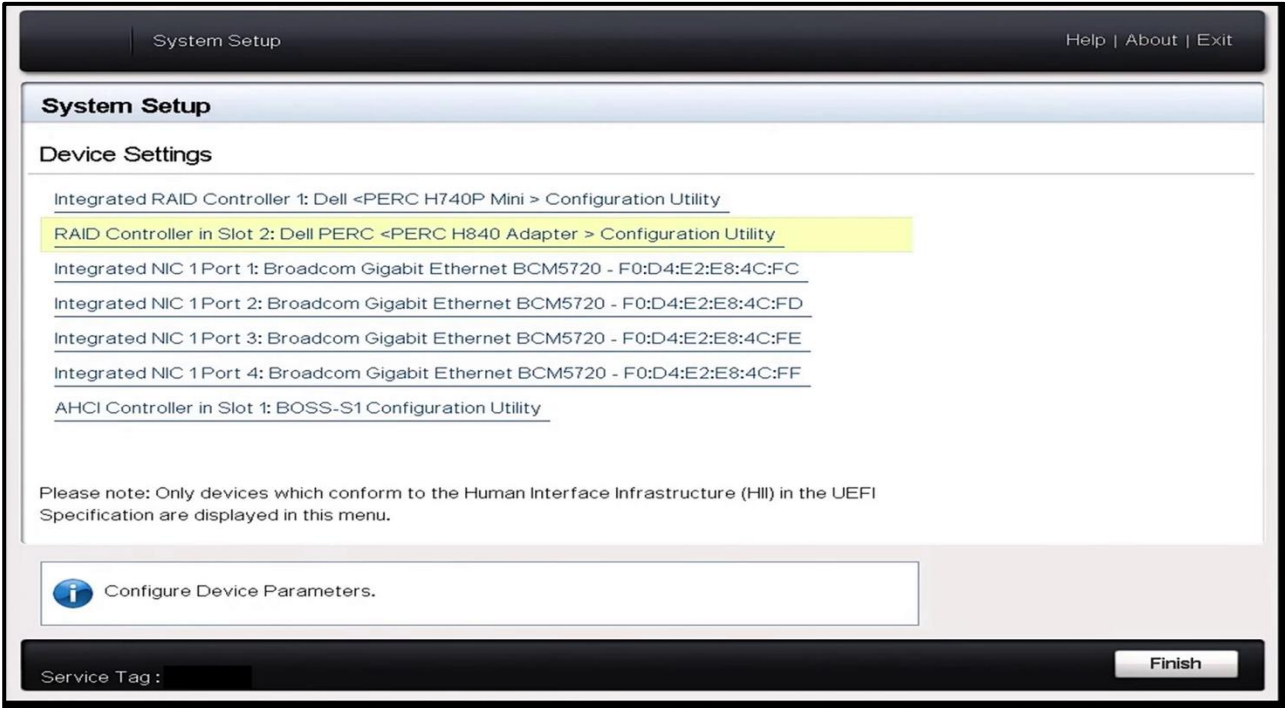

(4) Select 'Dashboard View > Main Menu'.

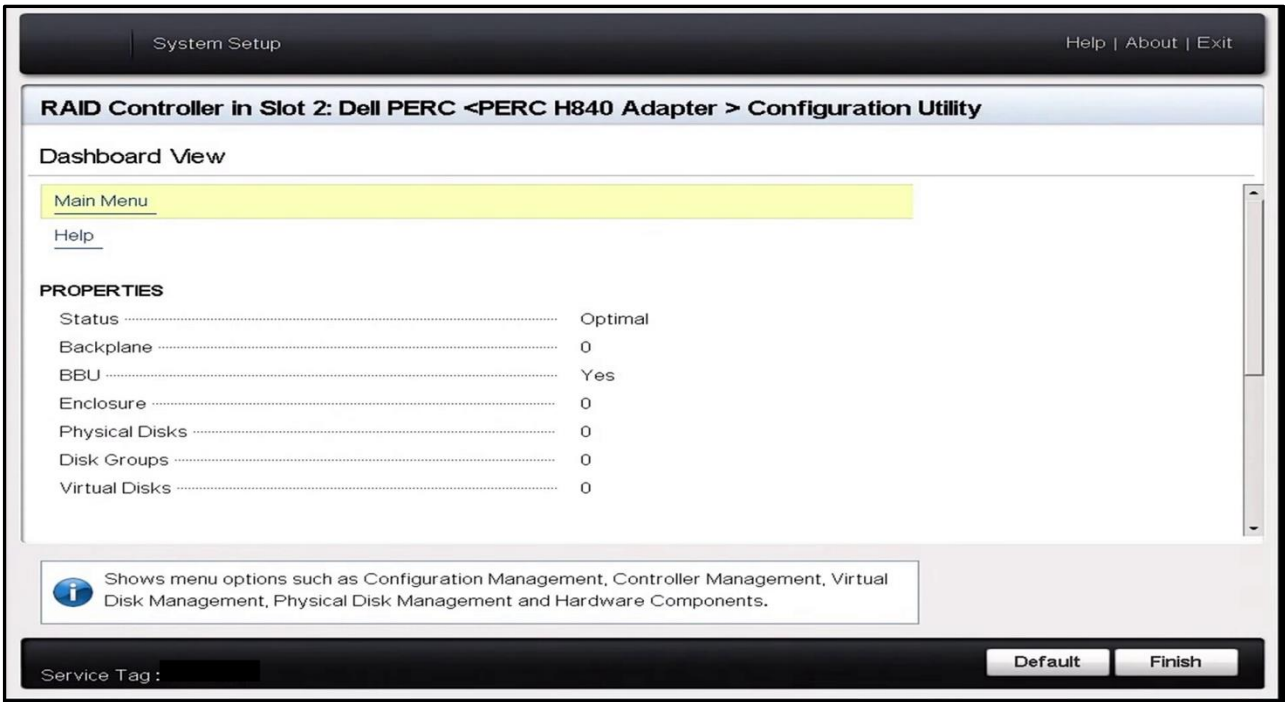

(5) Select 'Configuration Management > Create Virtual Disk'.

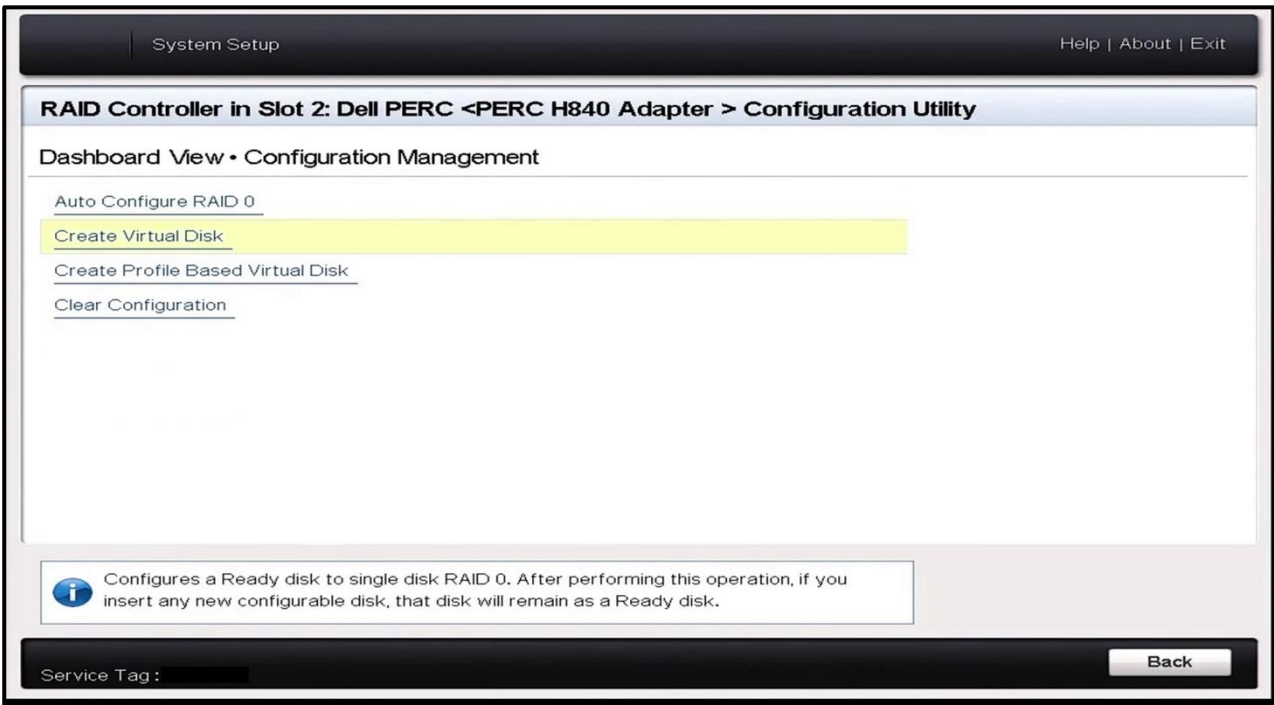

(6) Configure the main elements from 'Create Virtual Disk' menu.
- Select RAID Type.

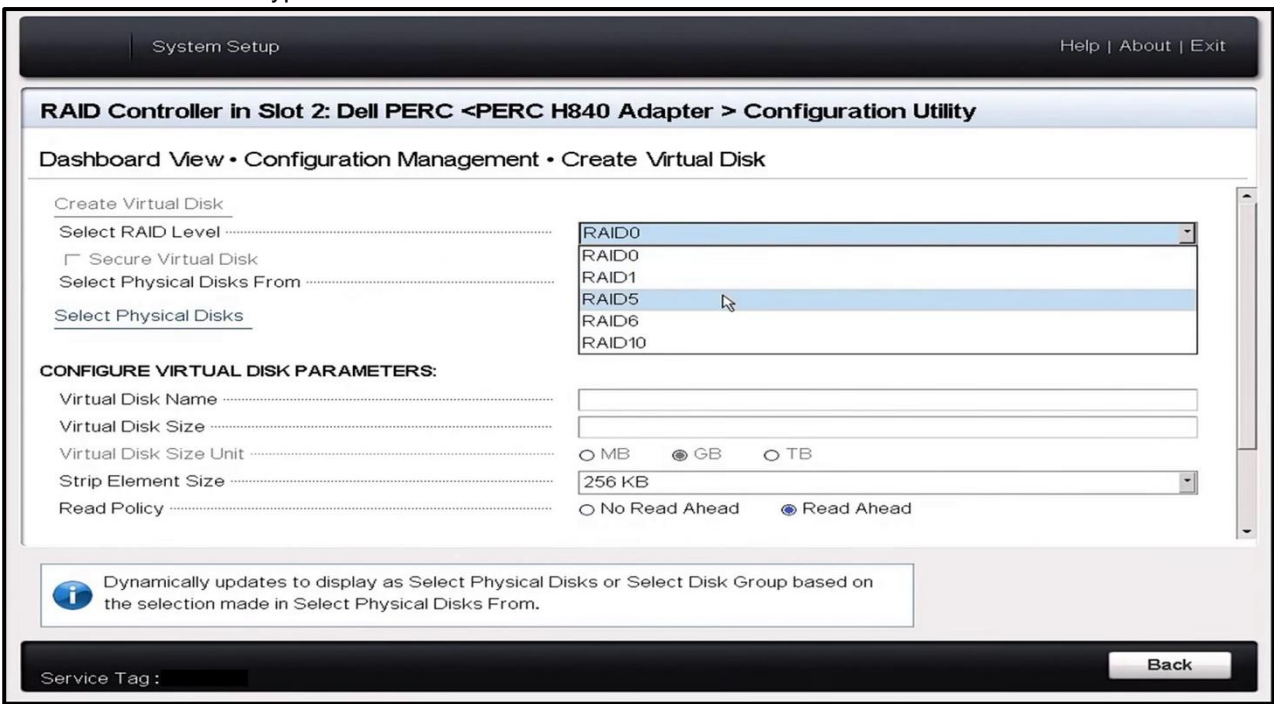

- You can select HDDs for your RAID level by ticking HDDs from 'Select Physical Disk'. After selecting the desired HDDs, press 'Apply Changes'.

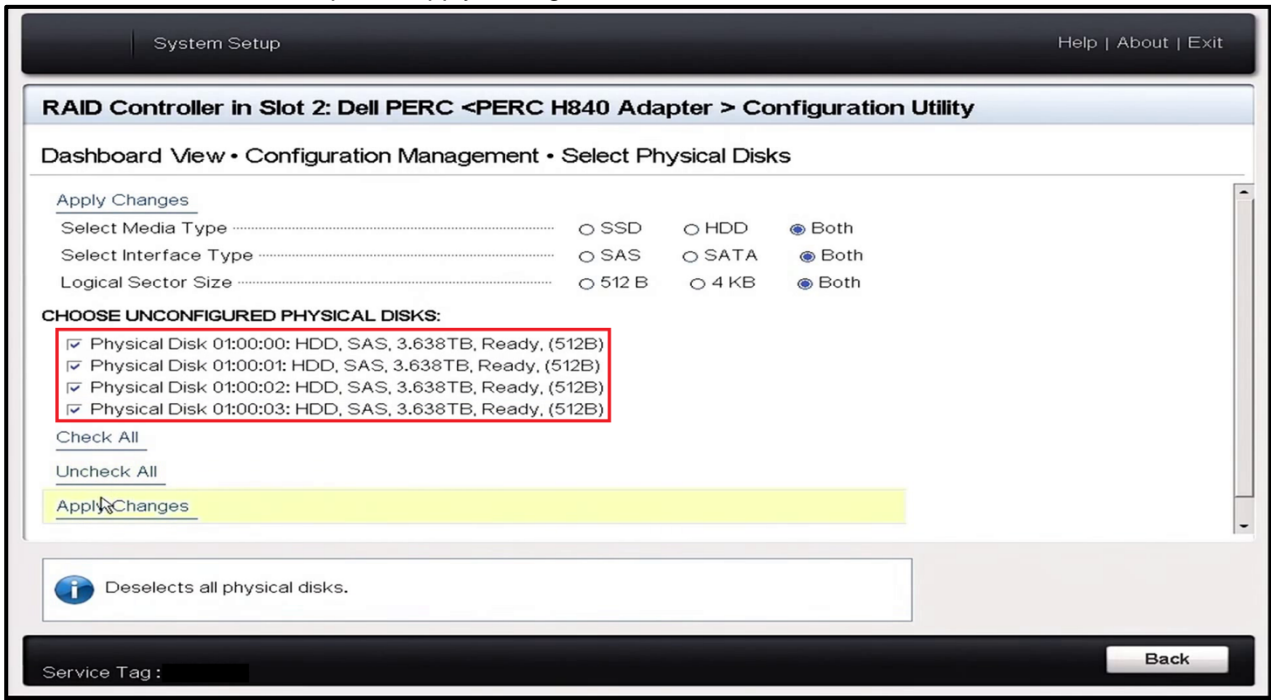

- Insert information of HDDs at 'Virtual Disk Name' and check if the Virtual Disk Size is correct.

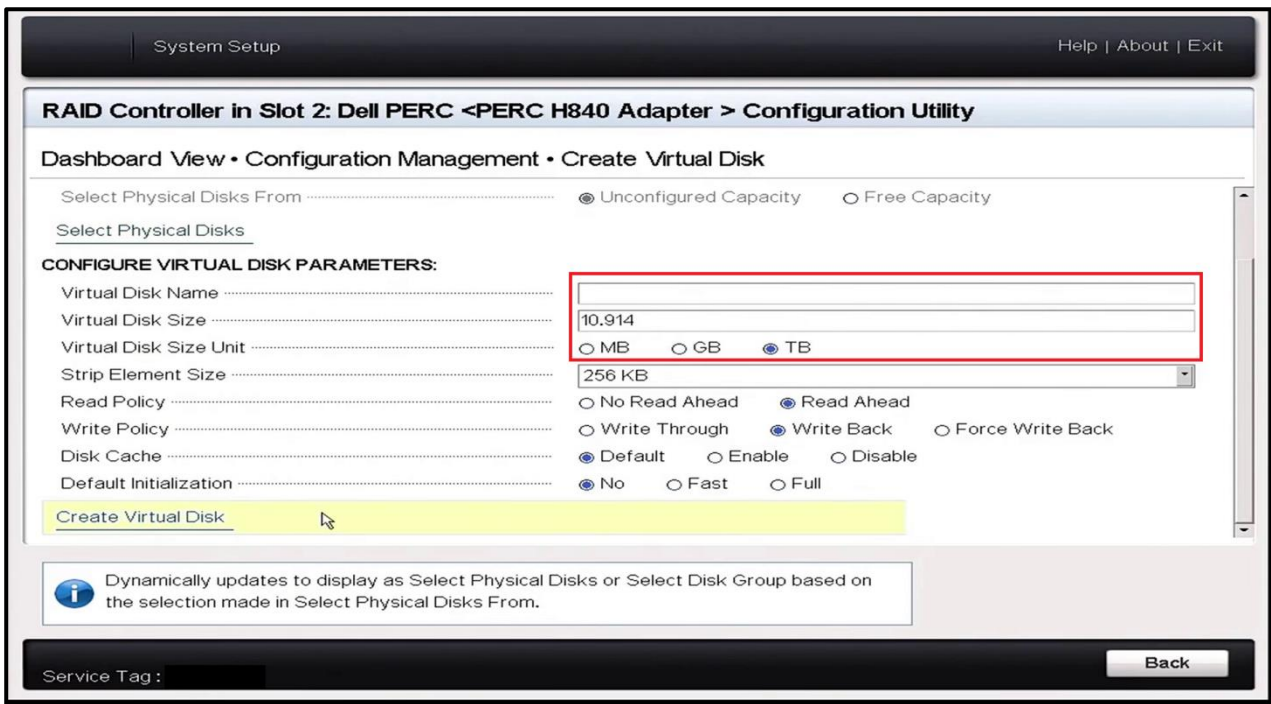

- After configuration, run 'Create Virtual Disk'.

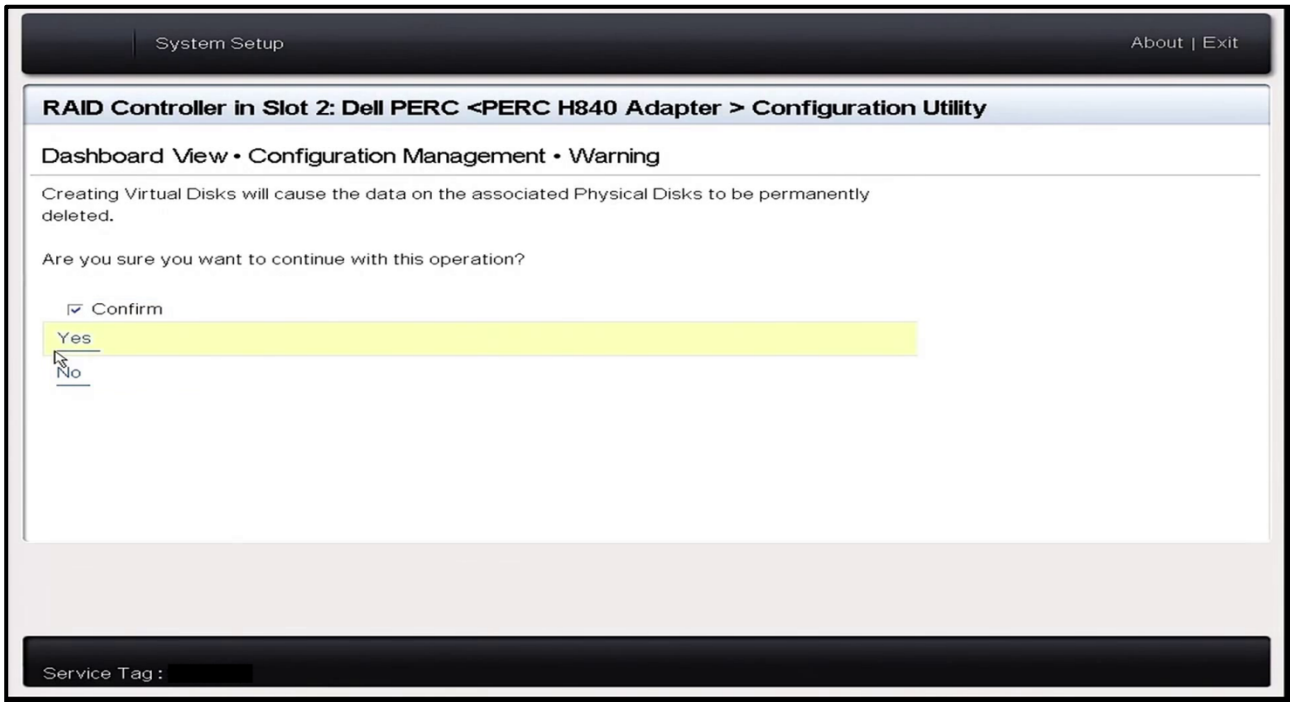
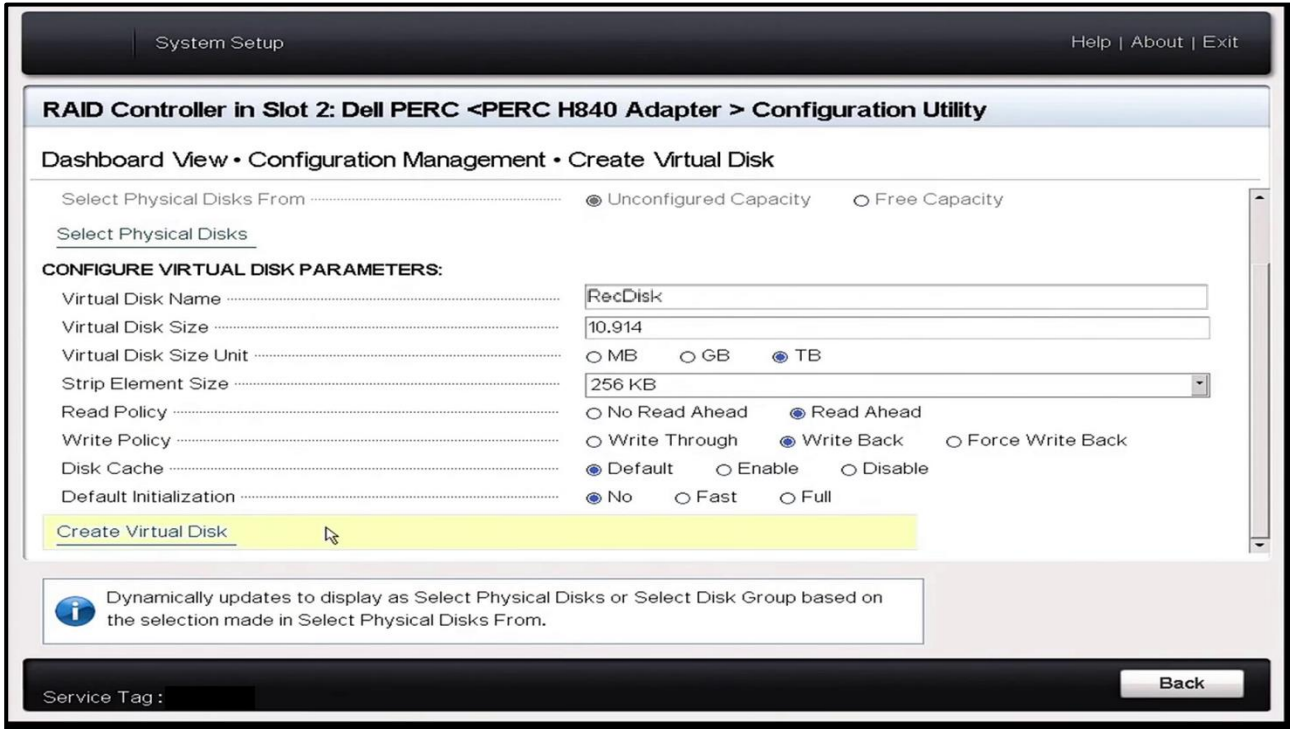

(7) Check the virtual disk is configured correctly at 'Main Menu > Virtual Disk Management' screen.

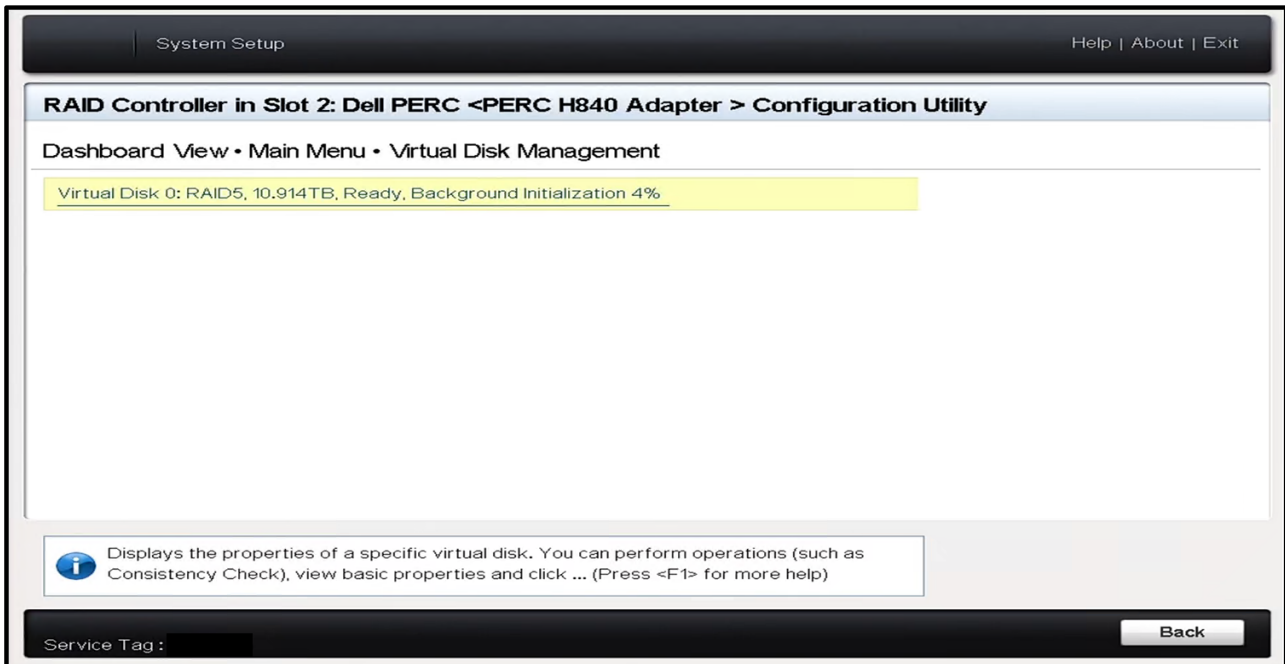

(8) Finish the 'System Setup' by clicking the 'Finish' button at 'Main Menu'.

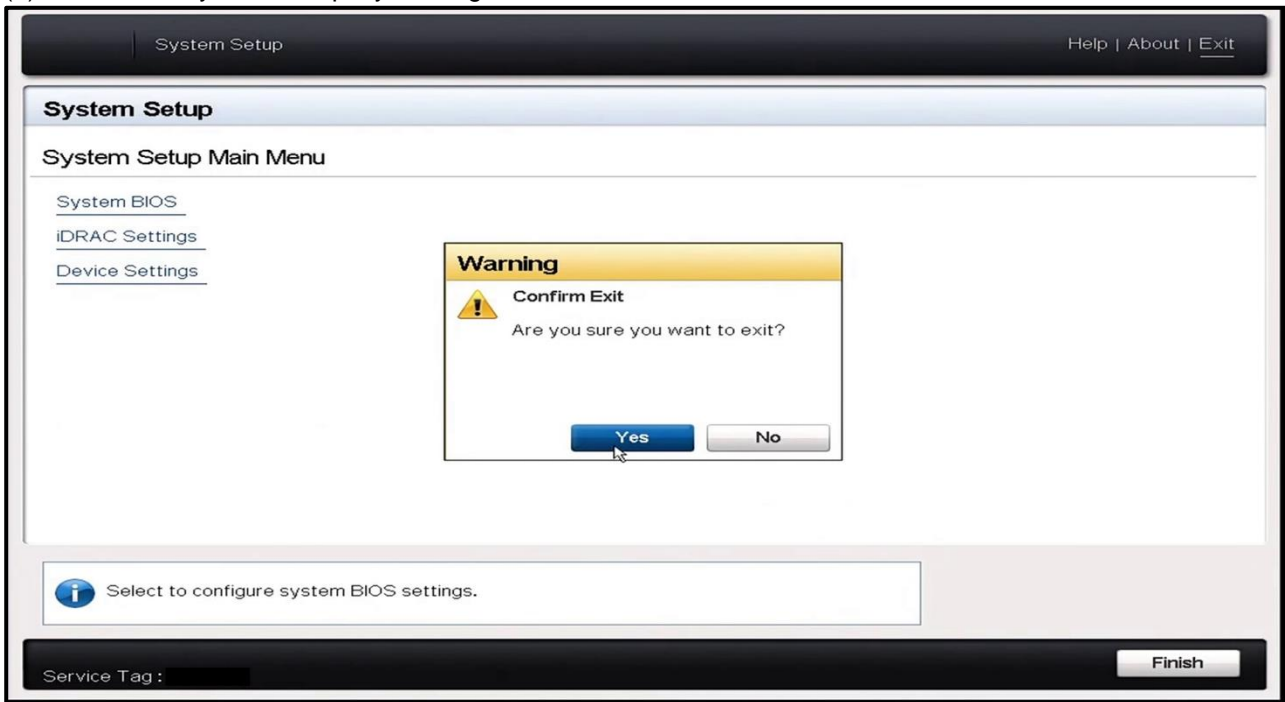

- (9) After the Windows OS boot up, you can see the information on the newly created Virtual Disk at 'Windows Setup > Disk Management' menu.

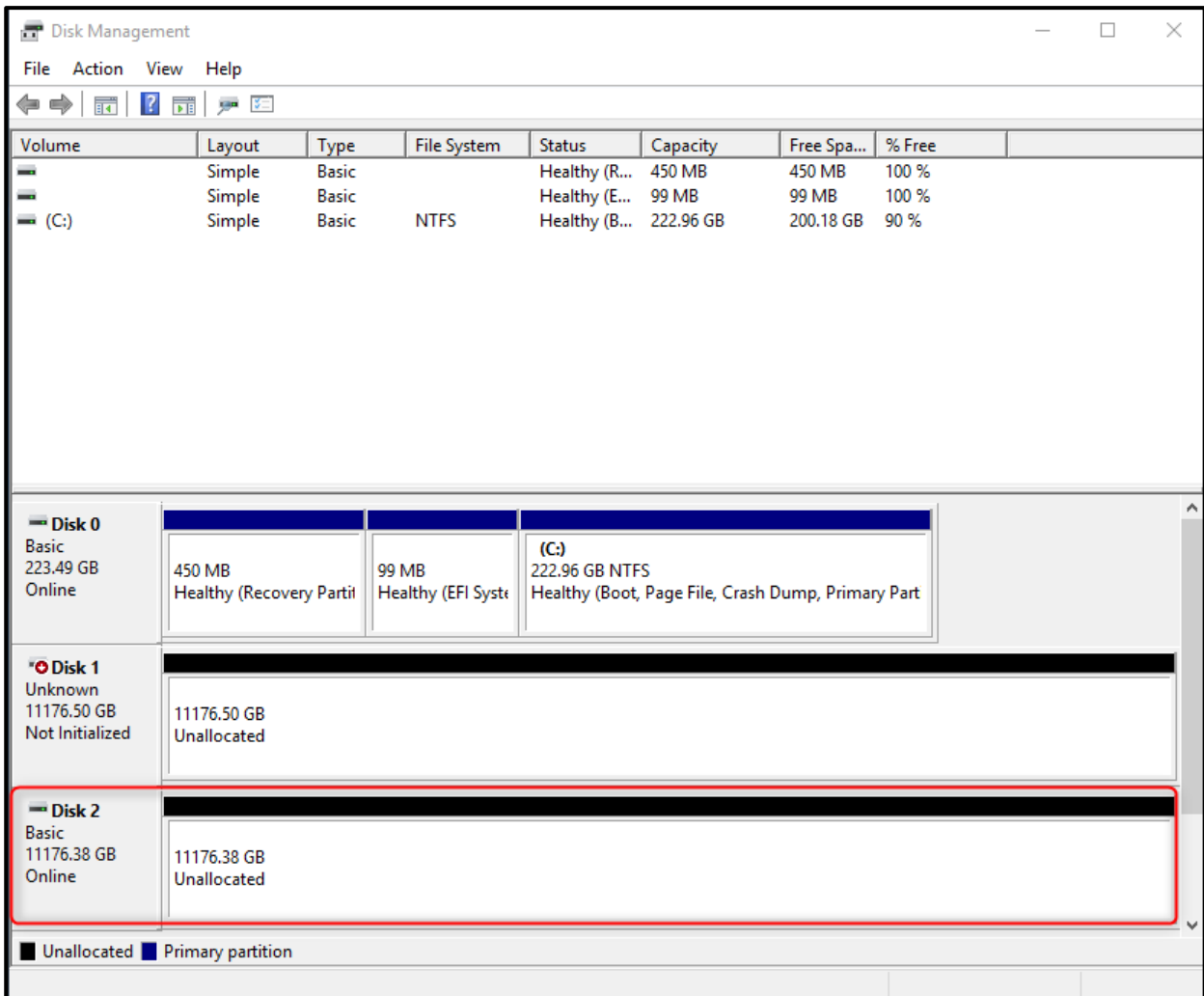

4.4 StarNET Pro

StarNET Pro installation package is on the system and the installation process is as the below.

- (1) Check the version of StarNET Pro(name of the folder) from the Desktop of Windows OS and also check if the document folder and compressed files are included.
 - Document: StarNET Pro installation and operation manual.
 - Standard.zip : Installation package for StarNET Pro Expert, Federation service.

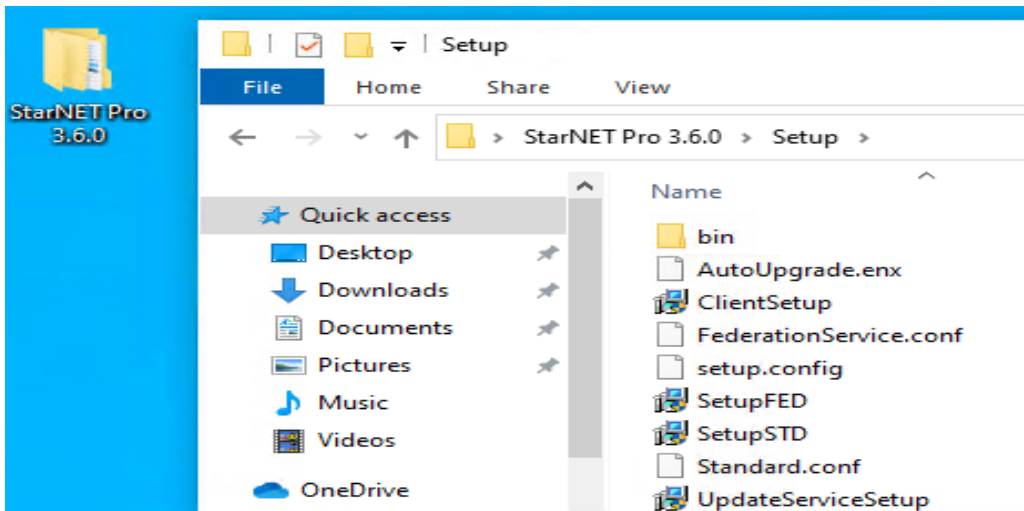

- (2) Check the Software License for StarNET Pro, then install StarNET Pro Standard or Federation on the C drive. Please refer to the documents in the Document folder for installation and configuration.
 - To install StarNET Pro Standard: Unzip Standard.zip and run Setup/Setup.exe.
 - To install StarNET Pro Federation: Unzip Standard.zip and run Setup/Federation.exe.

4.5 Teaming Network Interface Controller(NIC)

CSP-10SVR256 has four RJ45 ports and users can use different

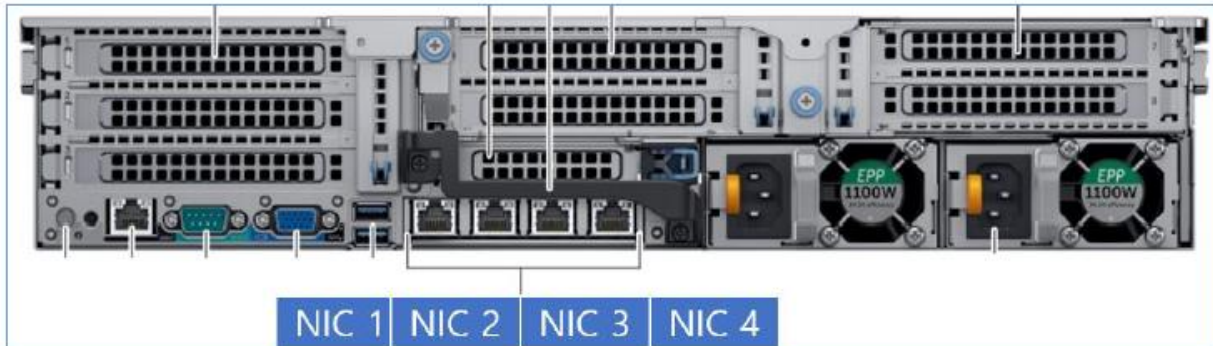

Network adapter teaming is a term that is used to describe various methods of combining multiple network connections to increase throughput or provide redundancy.

There are two main types of network teaming settings and four in total. They are as follows:

LACP(Link Aggregation Control Protocol)

IEEE 802.3ad Dynamic Link Aggregation: Also known as Link Aggregation Control Protocol (LACP) or IEEE 802.1ax. This type of team provides increased throughput by bundling multiple physical links into one logical link whose effective bandwidth is the sum of that of the physical links. This type of team requires that the switch on the other end of the connection support LACP. The switch must be properly configured for the team to function properly.

Generic Trunking: Also known as static link aggregation, this type of team provides the same type of bundling functionality as IEEE 802.3ad/802.1ax but does not use LACP. The switch does not have to support LACP but must be properly configured for this type of team in order to function.

Smart Load Balancing and Failover

Smart Load Balancing (SLB) and Failover: This type of team balances network traffic across all primary adapters. If a primary adapter fails, the remaining primary adapters continue to balance the load. If all primary adapters fail, traffic continues to flow using the standby adapter with no interruption. Once a primary adapter is brought back online, traffic resumes flowing through it.

SLB with Auto Fallback Disable: This type of team functions as above, but traffic does not automatically revert to the primary adapter once it comes back online.

Setting Up NIC Teaming

***Please note that some teaming options require specific switches and network settings.

4.5.1 Setting NIC Teaming Port

(1) Run Server Manager from Start Menu.

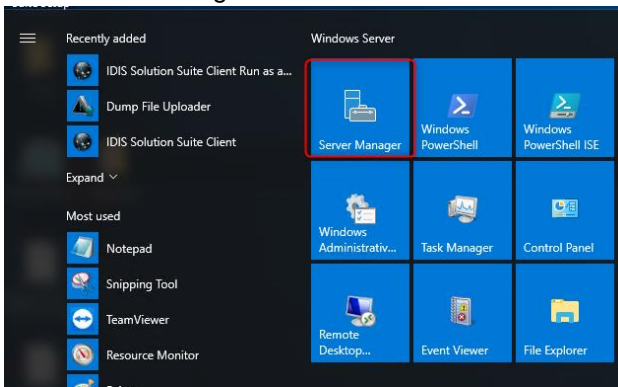

(2) Go to Local Server.

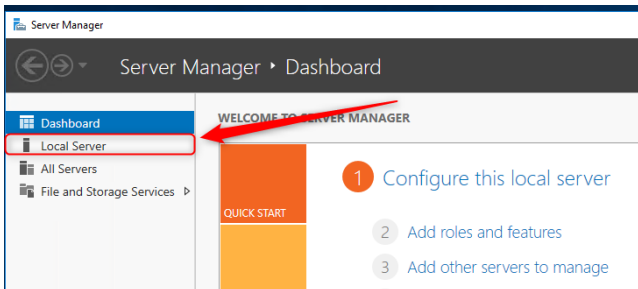

(3) Go to NIC Teaming setup menu.

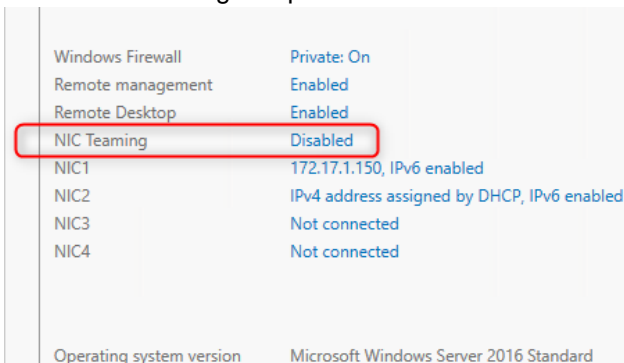

(4) Click 'Tasks' and select 'Add to New Team'.

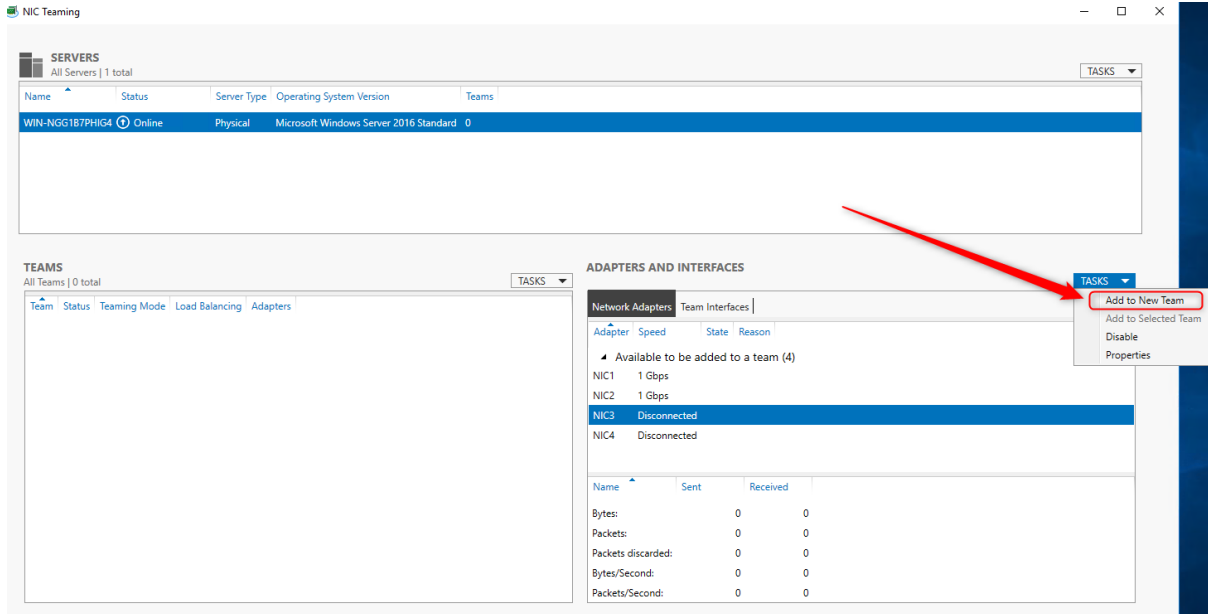

(5) Set name and desired ports.

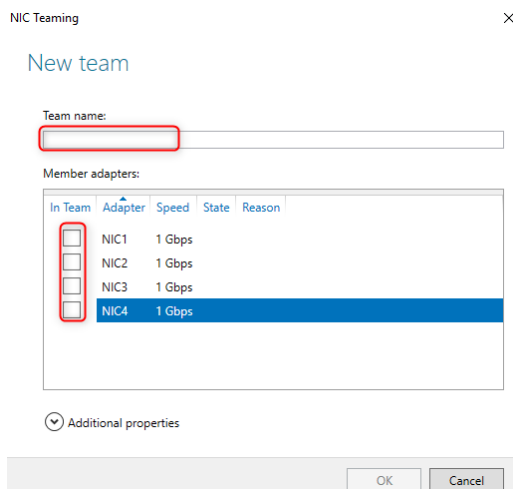

4.5.2 Setting NIC Teaming Type

- (1) Additional settings can be done on the 'Additional properties' section. Set options for your desired Teaming setting and click the OK button. The picture below shows available options.

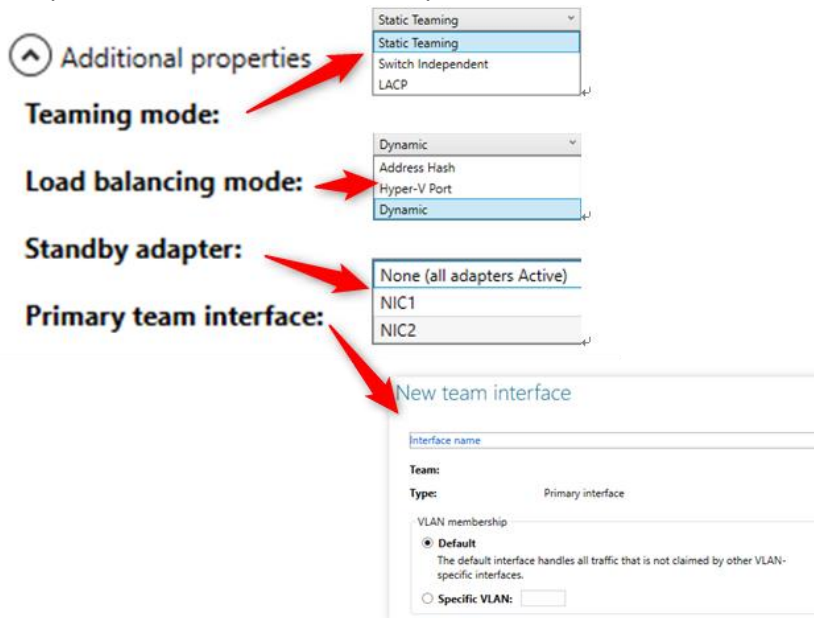

- (2) Teaming mode: select desired Teaming mode
- Static teaming(Static Link Aggregation): This option requires specific settings from switch and host(server)
 - Switch Independent: This option is for failover.
 - LACP: This option is for IEEE 802.3ad Dynamic Link Aggregation with LACP.
- (3) Load balance mode: select desired Load Balancing Mode,
- Address Hash: Inbound and outbound traffic controlled statically.
 - Hyper-V Port: This option is for setting up VM (Virtual Machine) port
 - Dynamic: This is an option for the best performance in most cases. It provides a dynamic load balancing.
- (4) Standby adapter: setting up the primary NIC.
- (5) Primary team interface: setting up Specific VLAN.

The next chapter will show you two main NIC teaming examples (LACP, Failover).

4.5.3 Setting LACP Teaming Mode.

(1) Go to Add to New Team setup and set as the picture below.

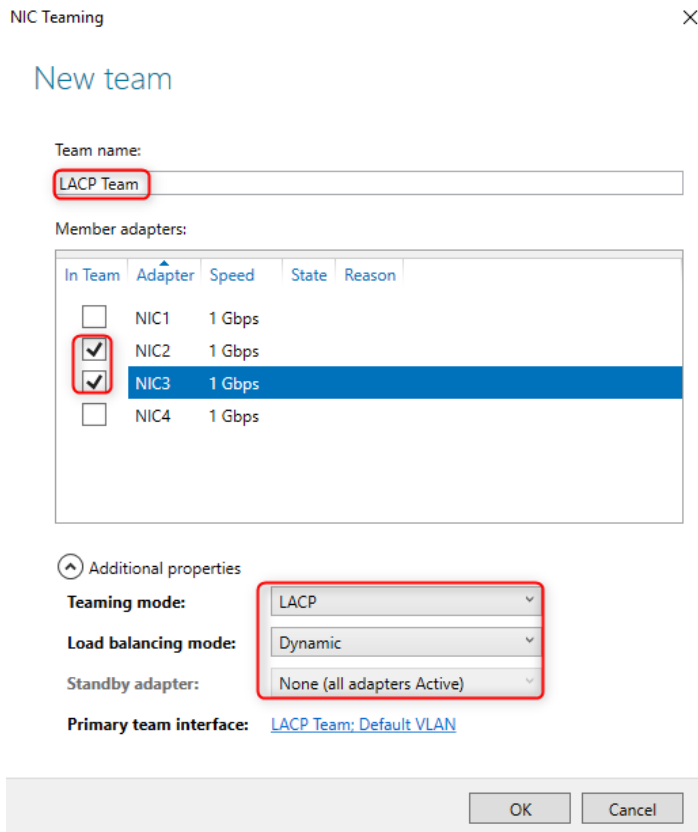

(2) Wait until the new setting is saved. Your current network setting will be lost (e.g. IP settings).

(3) Check the result.

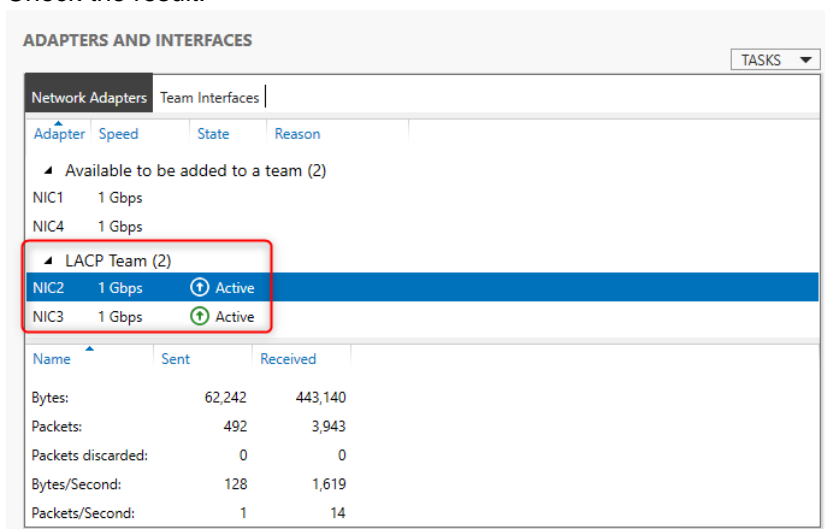

View your basic network information and set up connections

View your active networks

Network
Private network

Access type: Internet
Connections: LACP Team
NIC1
NIC4

Change your networking settings

4.5.4 Setting Failover Teaming Mode

(4) Go to Add to New Team setup and set as the picture below.

NIC Teaming ×

New team

Team name:

Member adapters:

In Team	Adapter	Speed	State	Reason
<input type="checkbox"/>	NIC1	1 Gbps		
<input checked="" type="checkbox"/>	NIC2	1 Gbps		
<input checked="" type="checkbox"/>	NIC3	1 Gbps		
<input type="checkbox"/>	NIC4	1 Gbps		

Additional properties

Teaming mode:

Load balancing mode:

Standby adapter:

Primary team interface: [Failover\(NIC2 Primary\); Default VLAN](#)

(5) Wait until the new setting is saved. Your current network setting will be lost(e.g. IP settings)

(6) Check the result.

Adapter	Speed	State	Reason
Available to be added to a team (2)			
NIC1	1 Gbps		
NIC4	1 Gbps		
Failover(NIC2 Primary) (2)			
NIC2	1 Gbps	Standby	
NIC3	1 Gbps	Active	

Name	Sent	Received
Bytes:	21,380	469,903
Packets:	188	3,725
Packets discarded:	0	0
Bytes/Second:	0	1,570
Packets/Second:	0	17

[View your basic network information and set up connections](#)

View your active networks

Network
Private network

Access type: Internet
Connections: Failover(NIC2 Primary)
NIC1
NIC4

5 Licenses and Service Codes

5.1 Windows OS License

Windows OS Key is required for certifying the reinstalled Windows OS and you can find it as follows.

(1) Find the Windows OS Key on the top chassis of the product.



(2) Scrape the hidden portion off the keys and check the full information of Windows OS Key.

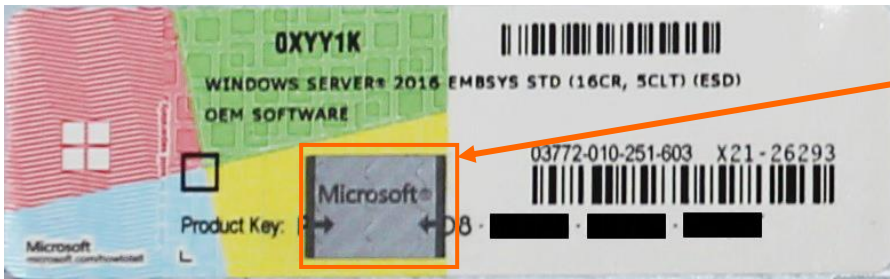

Scrape off hidden keys

5.2 StarNET Pro License

StarNET Pro License is not included in this product. It will be delivered separately by the seller. If you need to re-activate License due to an abnormal situation(e.g. changing server), please refer to manuals in StarNET Pro installation folder on your desktop of Windows OS.

5.3 Service Tag or Express Service Code

Service Tag or **Express Service Code** is required for device specific service as well as checking warranty and you can find it as follows.

- (1) Find the Information Tag panel on the right bottom of the product and pull it forward.

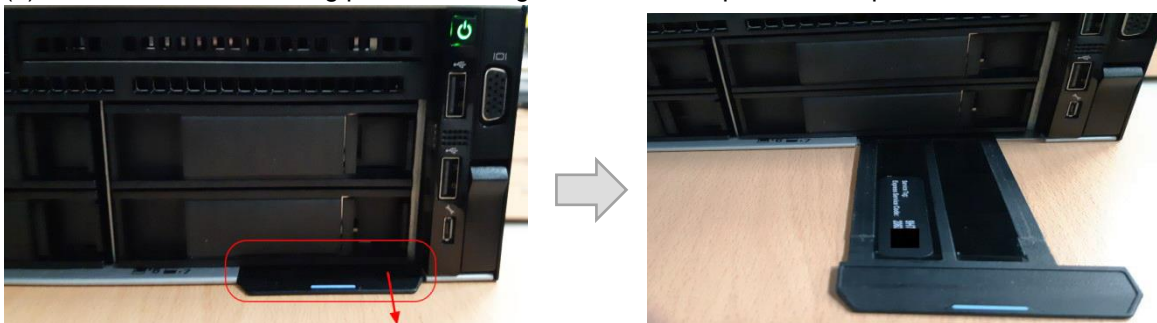

- (2) The Service Tag and Express Service Code will be shown in front of Information Tag.

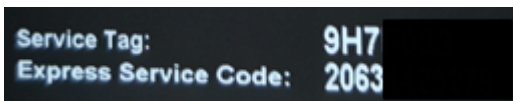

6 Specification

SYSTEM	
StarNET Pro	Compatible with Standard and Federation/Version 2.6.0 or Higher
Network Connection	4 GbE RJ-45 Ports (1000Base-T)
Recording Data Rate	Up to 1024Mbps (128MBps)
Number of Cameras	Up to 256
Recording Storage	8 Bay
Hard Disk Driver Configuration	Up to 8 x Large Form Factor Near-line SATA Hard Disk Drives, Hot-swappable, RAID 5, RAID 6
Operating System	Microsoft® Embedded Windows Server 2016
Processor	Intel® Xeon® Processor silver 4210 2.2G, 10C/20T
Memory	8GB RAM (1 x 8GB DDR4-2666MT/s RDIMM)
Video Outputs	1 VGA

MECHANICAL	
Form Factor	2U rack Mount Chassis
Dimensions (W x D x H)	482.0mm x 717.6mm x 86.8mm (18.98" x 27.71" x 3.41")
Weight	34.5kg (76 lbs)

ELECTRICAL	
Power Input	100-240V AC, 50/60Hz
Power Supply	Redundant, Hot Swappable
Power Capacity	750W

ENVIRONMENTAL	
Operating Temperature	10° to 35°C (50° to 95°F)
Storage Temperature	-40° to 65°C (-40° to 149°F)
Operating Humidity	10% to 80% Relative Humidity
Non-operating Humidity	5% to 95% Relative Humidity, 38.7°C (101.7°F) Maximum Wet Bulb Temperature, Non-condensing
Operating Vibration	0.26 Grms at 5 Hz to 350 Hz
Storage Vibration	1.88 Grms at 10 Hz to 500 Hz for 15 min
Operating Shock	Six consecutively executed shock pulses in the positive and negative x, y, and z axes of 6 G for up to 11ms
Storage Shock	Six consecutively executed shock pulses in the positive and negative x, y, and z axes (one pulse on each side of the system) of 71 G for up to 2 ms
Operating Altitude	3048m (10,000ft)
Storage Altitude	12,000 m (39,370 ft)

ACCESSORIES SUPPLIED	
Rack Rail System	Sliding rail system with cable management arm. Supports: <ul style="list-style-type: none"> - Tool-less mounting in 19"-wide EIA-310-E compliant square hole and unthreaded round-hole 4-post racks - Tooled mounting in threaded hole 4-post racks
Cable Management Arm	Yes
Rack Bezel	1, Front
Power Cord	1

CERTIFICATIONS	
Emissions Classification	FCC Rating Class A
EMC	CISPR 22; EN55022; EN55024; FCC CFR 47; Pt 15; ICES-003; CvNS14336-1; CNS13438; GB4943; GB9254; EN 61000-3-2; EN61000-3-3
Directives	RoHS, Reach(SVHC), WEEE

7 Warranty

The warranty period for this product is 3 years.