

Digital Video Recorder

Installation Manual

CR8015ET

CR1615ET



WARNING

RISK OF ELECTRIC SHOCK
DO NOT OPEN



WARNING: TO REDUCE THE RISK OF ELECTRIC SHOCK,
DO NOT REMOVE COVER (OR BACK).
NO USER-SERVICEABLE PARTS INSIDE.
REFER SERVICING TO QUALIFIED
SERVICE PERSONNEL.



The lightning flash with arrowhead symbol, within an equilateral triangle, is intended to alert the user to the presence of uninsulated "dangerous voltage" within the product's enclosure that may be of sufficient magnitude to constitute a risk of electric shock.



The exclamation point within an equilateral triangle is intended to alert the user to the presence of important operating and maintenance (servicing) instructions in the literature accompanying the appliance.

Symbol	Publication	Description
	IEC60417, No.5032	Alternating current

COMPLIANCE NOTICE OF FCC:

THIS EQUIPMENT HAS BEEN TESTED AND FOUND TO COMPLY WITH THE LIMITS FOR A CLASS A DIGITAL DEVICE, PURSUANT TO PART 15 OF THE FCC RULES. THESE LIMITS ARE DESIGNED TO PROVIDE REASONABLE PROTECTION AGAINST HARMFUL INTERFERENCE WHEN THE EQUIPMENT IS OPERATED IN A COMMERCIAL ENVIRONMENT. THIS EQUIPMENT GENERATES, USES, AND CAN RADIATE RADIO FREQUENCY ENERGY AND IF NOT INSTALLED AND USED IN ACCORDANCE WITH THE INSTRUCTION MANUAL, MAY CAUSE HARMFUL INTERFERENCE TO RADIO COMMUNICATIONS. OPERATION OF THIS EQUIPMENT IN A RESIDENTIAL AREA IS LIKELY TO CAUSE HARMFUL INTERFERENCE, IN WHICH CASE USERS WILL BE REQUIRED TO CORRECT THE INTERFERENCE AT THEIR OWN EXPENSE.

WARNING: CHANGES OR MODIFICATIONS NOT EXPRESSLY APPROVED BY THE PARTY RESPONSIBLE FOR COMPLIANCE COULD VOID THE USER'S AUTHORITY TO OPERATE THE EQUIPMENT.

THIS CLASS OF DIGITAL APPARATUS MEETS ALL REQUIREMENTS OF THE CANADIAN INTERFERENCE-CAUSING EQUIPMENT REGULATIONS.

The information in this manual is believed to be accurate as of the date of publication even though explanation about some functions may not be incorporated. We are not responsible for any problems resulting from the use thereof. The information contained herein is subject to change without notice. Revisions or new editions to this publication may be issued to incorporate such changes.

The software included in this product contains some Open Sources. You may obtain the complete corresponding source code from us. See the Open Source Guide on the software CD (*OpenSourceGuide\OpenSourceGuide.pdf*) or as a printed document included along with the User's Manual.

Important Safeguards

<p>1. Read Instructions All the safety and operating instructions should be read before the appliance is operated.</p> <p>2. Retain Instructions The safety and operating instructions should be retained for future reference.</p> <p>3. Cleaning Unplug this equipment from the wall outlet before cleaning it. Do not use liquid aerosol cleaners. Use a damp soft cloth for cleaning.</p> <p>4. Attachments Never add any attachments and/or equipment without the approval of the manufacturer as such additions may result in the risk of fire, electric shock or other personal injury.</p> <p>5. Water and/or Moisture Do not use this equipment near water or in contact with water.</p> <p>6. Placement and Accessories Do not place this equipment on an unstable cart, stand or table. The equipment may fall, causing serious injury to a child or adult, and serious damage to the equipment. This equipment and cart combination should be moved with care. Quick stops, excessive force, and uneven surfaces may cause the equipment and cart combination to overturn. Do not place this equipment on a closed space. Sufficient amount of ventilation air is necessary to avoid increase of ambient temperature which can cause improper operation or the risk of fire.</p> <p>7. Power Sources This equipment should be operated only from the type of power source indicated on the marking label. If you are not sure of the type of power, please consult your equipment dealer or local power company. You may want to install a UPS (Uninterruptible Power Supply) system for safe operation in order to prevent damage caused by an unexpected power stoppage. Any questions concerning UPS, consult your UPS retailer. This equipment should be remain readily operable.</p> <p>8. Power Cords Operator or installer must remove power and TNT connections before handling the equipment.</p> <p>9. Lightning For added protection for this equipment during a lightning storm, or when it is left unattended and unused for long periods of time, unplug it from the wall outlet and disconnect the antenna or cable system. This will prevent damage to the equipment due to lightning and power-line surges.</p>	<p>10. Overloading Do not overload wall outlets and extension cords as this can result in the risk of fire or electric shock.</p> <p>11. Objects and Liquids Never push objects of any kind through openings of this equipment as they may touch dangerous voltage points or short out parts that could result in a fire or electric shock. Never spill liquid of any kind on the equipment.</p> <p>12. Servicing Do not attempt to service this equipment yourself. Refer all servicing to qualified service personnel.</p> <p>13. Damage requiring Service Unplug this equipment from the wall outlet and refer servicing to qualified service personnel under the following conditions: A. When the power-supply cord or the plug has been damaged. B. If liquid is spilled, or objects have fallen into the equipment. C. If the equipment has been exposed to rain or water. D. If the equipment does not operate normally by following the operating instructions, adjust only those controls that are covered by the operating instructions as an improper adjustment of other controls may result in damage and will often require extensive work by a qualified technician to restore the equipment to its normal operation. E. If the equipment has been dropped, or the cabinet damaged. F. When the equipment exhibits a distinct change in performance – this indicates a need for service.</p> <p>14. Replacement Parts When replacement parts are required, be sure the service technician has used replacement parts specified by the manufacturer or that have the same characteristics as the original part. Unauthorized substitutions may result in fire, electric shock or other hazards.</p> <p>15. Safety Check Upon completion of any service or repairs to this equipment, ask the service technician to perform safety checks to determine that the equipment is in proper operating condition.</p> <p>16. Field Installation This installation should be made by a qualified service person and should conform to all local codes.</p> <p>17. Correct Batteries Warning: Risk of explosion if battery is replaced by an incorrect type. Replace only with the same or equivalent type. Dispose of used batteries according to the instructions. The battery shall not be exposed to excessive heat such as sunshine, fire or the like.</p> <p>18. Tmra A manufacturer's maximum recommended ambient temperature (Tmra) for the equipment must be specified so that the customer and installer may determine a suitable maximum operating environment for the equipment.</p>
---	---



WEEE (Waste Electrical & Electronic Equipment)

Correct Disposal of This Product

(Applicable in the European Union and other European countries with separate collection systems)



This marking shown on the product or its literature, indicates that it should not be disposed with other household wastes at the end of its working life. To prevent possible harm to the environment or human health from uncontrolled waste disposal, please separate this from other types of wastes and recycle it responsibly to promote the sustainable reuse of material resources.

Household users should contact either the retailer where they purchased this product, or their local government office, for details of where and how they can take this item for environmentally safe recycling.

Business users should contact their supplier and check the terms and conditions of the purchase contract. This product should not be mixed with other commercial wastes for disposal.

Table of Contents

Chapter 1 — Introduction.....	1
Feature	1
Technical Overview.....	1
Chapter 2 — Installation	3
Package Contents.....	3
Required Installation Tools	3
Video Input	3
Alarm Input/Output.....	4
RS485 Port.....	4
RS232 Port.....	4
eSATA Port.....	5
Factory Reset Switch	5
Video Out.....	5
Network Port.....	5
Audio In/Out.....	6
Power Cord Connector.....	6
Chapter 3 — Configuration	7
Front Panel Controls	7
Camera Buttons (1 to 16).....	8
Enter Button.....	8
Arrow Buttons	8
Menu Button	8
ZOOM Button.....	8
PTZ Button	9
Panic Button	9
LED	9
Display Button.....	9
Monitor Button	9
Bookmark Button	9
Freeze Button	9
Alarm Button.....	9
Playback Buttons	10
Jog Dial, Shuttle Ring.....	10
USB Port	10
ID Button on Remote Control	10
Sequence Button on Remote Control	11
Clip Copy Button on Remote Control.....	11
Turning on the Power	11
Appendix.....	13
Error Code Notices.....	13
System Log Notices	14
Map of Screens.....	15
Troubleshooting	16
Specifications.....	17

Chapter 1 — Introduction

Feature

Your color digital video recorder (DVR) provides recording capabilities for eight or 16 camera inputs. It provides exceptional picture quality in both live and playback modes, and offers the following features:

- Live Monitoring for Each Channel
- Compatible with Color (NTSC or PAL) and B&W (CCIR and EIA-170) Video Sources
- Auto Detection for HD-TVI Input
- Auto Detection for NTSC and PAL
- H.264 Codec
- Multiple Monitor Connectors: 1 HDMI, 1 VGA, 1 SPOT
- UTC for Camera Menu Control via Coax Cable
- Multiple Search Engines (Date/Time, Calendar, Record Table, Event)
- Real-time Recording (480 Images per Second with Very High (Full HD) Resolution)
- Continuous Recording in Disk Overwrite Mode
- Video Recording via eSATA Interface
- 2 (USB 2.0) port
- Continues Recording while Transmitting to Remote Site and during Playback
- User-friendly Graphical User Interface (GUI) Menu System
- Multiple Recording Modes (Time-lapse, Pre-event, Alarm, Motion and Panic)
- Two-way Audio Communication
- 4-Channel Audio Recording and 1-Channel Audio Playback
- Text Input for ATM and POS
- Alarm Connections Include: Input, Output
- Built-in Alarm Buzzer
- Live or Recorded Video Access via Ethernet
- Time Synchronization using industry standard protocol
- IR Remote Control
- Self-diagnostics with automatic notification including hard disk drive S.M.A.R.T. protocol

Technical Overview

In addition to replacing both a time-lapse VCR and a multiplexer in a security installation, your DVR has many features that make it much more powerful and easier to use than even the most advanced VCR.

The DVR converts analog NTSC or PAL video to digital images and records them on a hard disk drive. Using a hard disk drive allows you to access recorded video almost instantaneously; there is no need to rewind tape. The technology also allows you to view recorded video while the DVR continues recording video.

Digitally recorded video has several advantages over analog video recorded on tape. There is no need to adjust tracking. You can freeze frames, fast forward, fast reverse, slow forward and slow reverse without image streaking or tearing. Digital video can be indexed by time or events, and you can instantly view video after selecting the time or event.

Your DVR can be set up for event or time-lapse recording. You can define times to record, and the schedule can change for different days of the week and user defined holidays.

The DVR can be set up to alert you when the hard disk drive is full, or it can be set to record over the oldest video once the disk is full.

Your DVR uses a proprietary encryption scheme making it nearly impossible to alter video.

You can view video and control your DVR remotely by connecting via Ethernet. There is an eSATA port that can be used to record (eSATA interface only) video to external hard disk drives, and there are two USB ports that can be used to upgrade the system or copy video clips to external hard disk and flash drives.

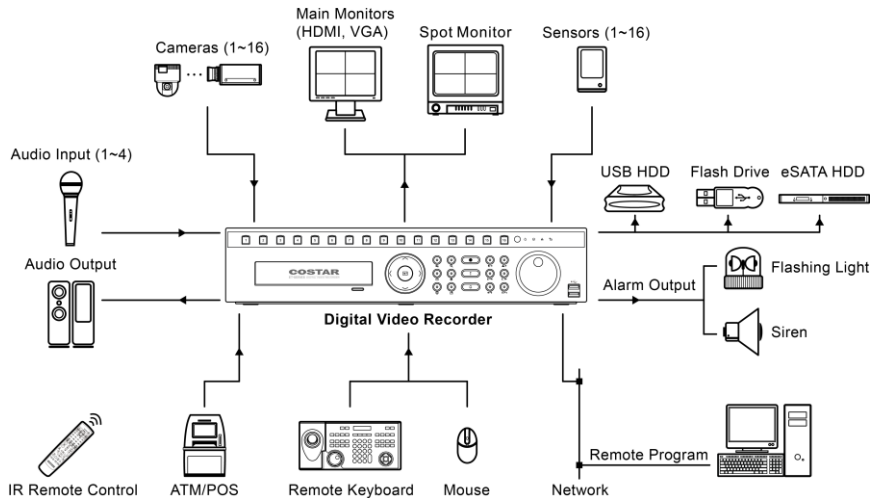

Figure 1: Typical DVR installation.

NOTE: This manual covers the 8- and 16-channel digital video recorders. The DVRs are identical except for the number of cameras and alarms that can be connected and the number of cameras that can be displayed. For simplicity, the illustrations and descriptions in this manual refer to the 16-camera model.

Chapter 2 — Installation

Package Contents

The package contains the following:

- Digital Video Recorder
- Power Cord
- Quick User Guide
- Software CD (User's Manual included)
- Rack-mount Kit
- Assembly Screws for Adding Hard Disk Drives
- SATA Cables
- Infrared Remote Control

Required Installation Tools

No special tools are required to install the DVR. Refer to the installation manuals for the other items that make up part of your system.

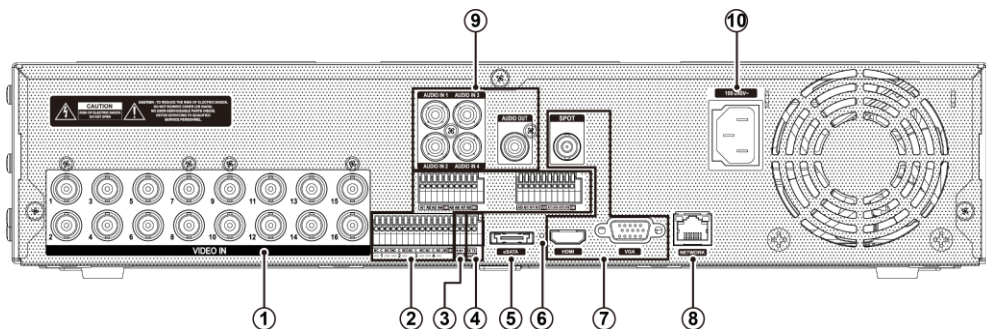

Figure 2: DVR rear panel.

- | | | | |
|----------------|------------------------|------------------------|----------------|
| ① Video Input | ② Alarm Input/Output | ③ RS485 Port | ④ RS232 Port |
| ⑤ eSATA Port | ⑥ Factory Reset Switch | ⑦ Video Out | ⑧ Network Port |
| ⑨ Audio In/Out | | ⑩ Power Cord Connector | |

Your DVR can be used with either NTSC or PAL equipment.

NOTE: You cannot mix NTSC and PAL equipment. For example you cannot use a PAL camera and an NTSC monitor.

Video Input

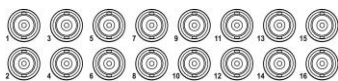

Connect the coaxial cables from the video sources to the BNC Video In connectors.

Alarm Input/Output

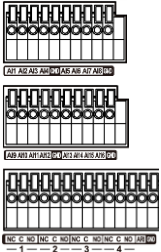

NOTE: To make connections on the Alarm Connector Strip, press and hold the button and insert the wire in the hole below the button. After releasing the button, tug gently on the wire to make certain it is connected. To disconnect a wire, press and hold the button above the wire and pull out the wire.

AI 1 to 16 (Alarm-In): You can use external devices to signal the DVR to react to events. Mechanical or electrical switches can be wired to the AI (Alarm-In) and GND (Ground) connectors. The threshold voltage of electrical switches for NC (Normally Closed) is above 2.4V and for NO (Normally Open) is below 0.3V, and should be stable at least 0.5 seconds to be detected. The voltage range of alarm input is from 0V to 5V. See *Chapter 3 – Configuration* for configuring alarm input.

GND (Ground): Connect the ground side of the Alarm input and/or alarm output to the GND connector.

NOTE: All the connectors marked GND are common.

NC/NO (Relay Alarm Outputs): The DVR can activate external devices such as buzzers or lights. Connect the device to the C (Common) and NC (Normally Closed) or C (Common) and NO (Normally Open) connectors. NC/NO is a relay output which sinks 2A@125VAC and 1A@30VDC. See *Chapter 3 – Configuration* for configuring alarm output.

ARI (Alarm Reset In): An external signal to the Alarm Reset In can be used to reset both the Alarm Out signal and the DVR’s internal buzzer. Mechanical or electrical switches can be wired to the ARI (Alarm Reset In) and GND (Ground) connectors. The threshold voltage is below 0.3V and should be stable at least 0.5 seconds to be detected. Connect the wires to the ARI and GND connectors.

Connector Pin Outs:

AI (1 to 16)	Alarm Inputs 1 to 16
GND	Chassis Ground
NC	Relay Alarm Out (Normally Closed)
C	Relay Common
NO	Relay Alarm Out (Normally Open)
ARI	Alarm Reset In

RS485 Port



The DVR can be controlled remotely by an external device or control system, such as a control keyboard, using RS485 half-duplex serial communications signals. The RS485 connector can also be used to control PTZ (pan, tilt, zoom) cameras. Connect RX+/TX+ and RX-/TX- of the control system to the + and - (respectively) of the DVR. See *Chapter 3 – Configuration* and the PTZ camera or remote controller manufacturer’s manual for configuring the RS485 connection.

Connector Pin Outs:

Master Unit		Slave Unit	
+	→ To	→	TX+/RX+
-	→ To	→	TX-/RX-

RS232 Port



An RS232 port is provided to connect remote control devices such as a control keyboard. PTZ cameras or text-in devices can also be connected to the RS232 port. See *Chapter 3 – Configuration* and the PTZ camera, text-in device or remote controller manufacturer’s manual for configuring the RS232 connection.

Connector Pin Outs:

Master Unit		Slave Unit	
RX	→ To	→	TXD
TX	→ To	→	RXD
GND	→ To	→	GND

NOTE: Refer to the following for pin-out details for the 9-pin connector of the slave unit.



Male



Female

Pin 2	RXD (Receive Data)
Pin 3	TXD (Transmit Data)
Pin 5	GND (Ground)

eSATA Port



An eSATA port is provided to connect external storage devices for recording or archiving video. Connect the external eSATA hard disk drive (RAID) cable to the eSATA port.

CAUTION: Do NOT connect or disconnect eSATA devices while the DVR power is on. The DVR must be powered down to connect or disconnect eSATA devices. Power up eSATA devices so they are ready for operation before powering up the DVR. Power down eSATA devices after powering down the DVR and then disconnect eSATA devices.

Factory Reset Switch



The DVR has a Factory Reset switch to the left of the HDMI connector on the rear panel. This switch will only be used on the rare occasions that you want to return all the settings to the original factory settings.

CAUTION: When using the *Factory Reset*, you will lose any settings you have saved.

To reset the unit, you will need a straightened paperclip:

1. Turn the DVR off.
2. Turn it on again.
3. Poke the straightened paperclip into the unlabeled hole to the left of the HDMI connector.
4. Hold the reset switch until the DVR's internal buzzer sounds twice.
5. Release the reset switch. All of the DVR's settings are now at the original settings it had when it left the factory.

Video Out



An HDMI (High-Definition Multimedia Interface) connector is provided so that you can use an HDMI monitor as your main monitor.

A VGA connector is provided so that you can use a standard, multi-sync computer monitor as your main monitor. Use the cable supplied with your monitor to connect it to the DVR.

Connect the spot monitor to the SPOT connector as needed.

NOTE: Connect the monitor before the DVR boots so that video can be displayed on the monitor with the resolution you have set during system setup. If you want to use both the HDMI and VGA Monitor connectors, one of the monitors should be connected before the DVR boots, and the other monitor should be connected after the DVR boots.

Network Port



The DVR can be networked using the 10Mb/100Mb/1Gb Ethernet connector. Connect a Cat5e cable with an RJ-45 jack to the DVR connector. The DVR can be networked with a computer for remote monitoring, searching, configuration and software upgrades. See *Chapter 3 – Configuration* for configuring the Ethernet connections.

CAUTION: The network connector is not designed to be connected directly with cable or wire intended for outdoor use.

Audio In/Out

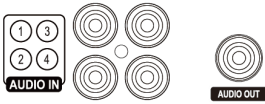

Your DVR can record audio from up to four sources. Connect the audio sources to Audio In 1, Audio In 2, Audio In 3 and Audio In 4 as needed using RCA jacks. Connect Audio Out to your amplifier.

NOTE: It is the user's responsibility to determine if local laws and regulations permit recording audio.

The DVR does not have amplified audio output, so you will need a speaker with an amplifier. The DVR does not have a pre-amplifier for audio input, so the audio input should be from an amplified source, not directly from a microphone.

Power Cord Connector



Connect the AC power cord to the DVR and then to a wall outlet.

WARNING: ROUTE POWER CORDS SO THAT THEY ARE NOT A TRIPPING HAZARD. MAKE CERTAIN THE POWER CORD WILL NOT BE PINCHED OR ABRADED BY FURNITURE. DO NOT INSTALL POWER CORDS UNDER RUGS OR CARPET. THE POWER CORD HAS A GROUNDING PIN. IF YOUR POWER OUTLET DOES NOT HAVE A GROUNDING PIN RECEPTACLE, DO NOT MODIFY THE PLUG. DO NOT OVERLOAD THE CIRCUIT BY PLUGGING TOO MANY DEVICES IN TO ONE CIRCUIT.

Your DVR is now ready to operate.

Chapter 3 — Configuration

NOTE: Your DVR should be completely installed before proceeding. Refer to *Chapter 2 — Installation*.

Front Panel Controls

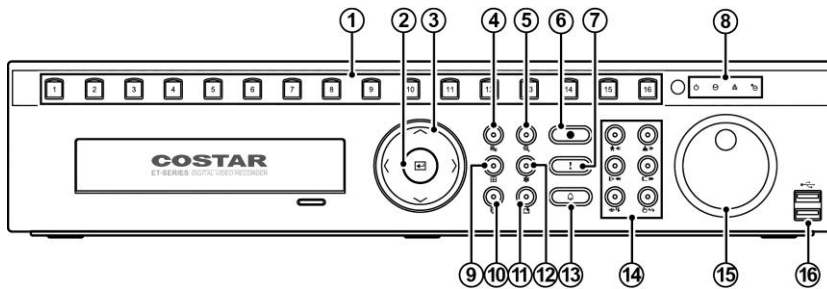

Figure 3: DVR front panel.

- | | | | |
|------------------|--------------------|---------------------|-----------------|
| ① Camera Buttons | ② Enter Button | ③ Arrow Buttons | ④ Menu Button |
| ⑤ Zoom Button | ⑥ PTZ Button | ⑦ Panic Button | ⑧ LED |
| ⑨ Display Button | ⑩ Monitor Button | ⑪ Bookmark Button | ⑫ Freeze Button |
| ⑬ Alarm Button | ⑭ Playback Buttons | ⑮ Jog Dial, Shuttle | ⑯ USB Port |

The front panel looks and operates much like a VCR combined with a multiplexer. Many of the buttons have multiple functions. The buttons on the infrared remote control, while laid out differently, perform the same functions as those on the front panel. The following describes each button and control. Take a few minutes to review the descriptions. You will use these to initially set up your DVR and for daily operations.

NOTE: The infrared sensor on the DVR is just to the right of the arrow buttons. Make certain that nothing blocks the sensor, or the remote control will not function properly.

When you use wireless communication devices (such as Wi-Fi or Bluetooth) near the DVR, the remote control might not function properly.

You can also use a USB mouse (not supplied) to navigate through the screens and menus much like you would on a computer.

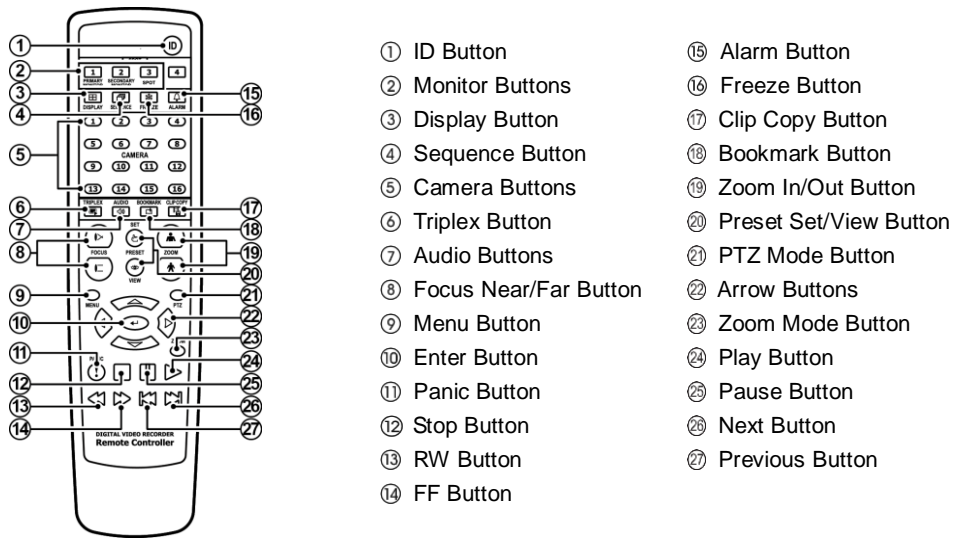



Figure 4: Infrared remote control.

NOTE: For simplicity, the button descriptions in this manual refer to the front panel buttons.

Camera Buttons (1 to 16)

Pressing the individual camera buttons will cause the selected camera to display full screen.

Enter Button

The  (Enter) button selects a highlighted item or completes an entry that you have made during system setup.

Arrow Buttons

These buttons are used to navigate through menus and GUI. You can also use them to change numbers by highlighting a number in the menu and using the Up and Down arrow buttons to increase or decrease the number's value. These buttons are also used to control Pan and Tilt when in the PTZ mode.

When in the PIP display format, pressing the Up and Down arrow buttons moves the position of the small screen counter-clockwise and clockwise.

Pressing the Left and Right buttons moves through screen pages in the Live Monitoring mode and Search mode.

Menu Button

Pressing the  button enters the Setup screen. You will need to enter the authorized user and password to access Setup. Pressing the button also closes the current menu or setup dialog box. In the Playback mode, pressing the button displays the Search menu. In the Search mode clip-copying can be done instantly by pressing and holding the button for three or more seconds.

ZOOM Button

Pressing the  button zooms the current image on the screen. A PIP with a rectangle temporarily displays showing what area of the screen has been enlarged. You can use the arrow buttons to move the rectangle to another area.

PTZ Button

Pressing the **PTZ** button enters the PTZ (Pan/Tilt/Zoom) mode which allows you to control properly configured cameras.

Panic Button

Pressing the **PANIC** button starts panic recoding of all camera channels, and displays  on the screen. Pressing the button again will stop panic recording.

LED

- **Power LED:** The Power LED is lit when the unit is On.
- **Network LED:** The Network LED is lit when the unit is connected to a network via Ethernet.
- **eSATA LED:** The eSATA LED is lit when an eSATA device is connected to the DVR.
- **HDD LED:** The HDD LED flickers when the DVR is recording or searching video on the hard disk drive.

Display Button

Pressing the **DISPLAY** button toggles between different display formats. The available formats are: PIP, 2x2, 3x2, 3x3, or 4x4.

Monitor Button

Pressing the **MONITOR** button toggles the monitor selection between Main and Spot. You can select the screen format and sequence monitoring of the selected monitor.

Bookmark Button

When in the playback mode, pressing the **BOOKMARK** button adds the current playback point to the bookmark list or moves to the registered bookmark point.













Freeze Button

Pressing the **FREEZE** button freezes the current live screen.







Alarm Button

The **ALARM** button has two functions. First, it will reset the DVR's outputs including the internal buzzer during an alarm. Second, it will display the event log when you are in the live monitoring mode unless there is an active alarm.

Playback Buttons

- **Backward:** When in the pause mode, pressing the  button moves to the previous image. The button is also used to Zoom Out while in the PTZ mode.
- **Forward:** When in the pause mode, pressing the  button moves to the next image. The button is also used to Zoom In while in the PTZ mode.
- **Rewind:** Pressing the  button plays video backward at high speed. Pressing the button again toggles the playback speed from  and . The button is also used for Near Focus in the PTZ mode.
- **Play/Pause:** Pressing the  button plays back video at regular speed. The screen displays  when the DVR is in the Pause mode and the screen displays  when the DVR is playing back video. The button is also used to save Presets while in the PTZ mode.
- **Fast Forward:** Pressing the  button plays video forward at high speed. Pressing the button again toggles the playback speed from  and . The button is also used for Far Focus in the PTZ mode.
- **Search/Stop:** Pressing the  button while in the Live Monitoring mode enters the Search mode. Pressing the  button while in the Search mode returns the DVR to the Live Monitoring mode. The button is also used to load a Preset View in the PTZ mode.

Jog Dial, Shuttle Ring

- **Jog Dial:** When in the playback mode, you can play video forward image-by-image by turning the Jog Dial clockwise and backward image-by-image by turning the Jog Dial counterclockwise. When in the PIP mode, you can make the PIP screen smaller by turning the Jog Dial clockwise and larger by turning the Jog Dial counterclockwise. When in the Setup mode, you can change number values by highlighting the item in the menu and turning Jog Dial clockwise or counterclockwise to increase or decrease the number.
- **Shuttle Ring:** The Shuttle Ring only functions in the Playback mode. The Shuttle Ring is spring loaded and returns to the center position when released. Turning the ring clockwise plays video forward. Turning the ring counterclockwise plays video backward. Playback speed varies with the amount the ring is turned. The playback speeds are , , , ,  and . When you release the ring, it snaps back to the center position and the video pauses.

USB Port

Two USB ports on the front panel are provided to connect external hard disk or flash drives for video clip copying or system upgrades. Position external drives close enough to the DVR so that you can make the cable connections, usually less than 6 feet. Use the USB cable provided with the hard disk drive to connect it to the DVR.

A USB mouse (not supplied) can be connected to one of the ports. You can use the mouse to navigate through the screens and menus much like you would on a computer.

A PostScript™ USB printer (not supplied) can be connected to one of the ports. You can print selected images resulting from a search.

A USB to Serial converter can be connected to the USB port. Multiple text-in devices can be used with a USB to Serial converter.

ID Button on Remote Control

If a DVR System ID is set to 0, the infrared remote control will control that DVR without any additional operations. (Refer to the *System – General* setup screen in this chapter for further information on setting the System ID.) If the system ID is 1 to 16, you must to press the  button and then press the number button (1 to 16) in order to control that DVR. If the System ID of two or more DVRs is set to 0, those DVRs will react to the infrared remote control at the same time.

Sequence Button on Remote Control

Pressing the **SEQUENCE** button displays live channels sequentially.

Clip Copy Button on Remote Control

Pressing the **CLIP COPY** button allows you to copy video clips.

Turning on the Power

Connecting the power cord to the DVR turns on the unit. The unit takes approximately one minute and 30 seconds to initialize.

Appendix

Error Code Notices

System Upgrade Related		Clip Copy Related	
No.	Description	No.	Description
0	Unknown error.	0	Unknown error.
1	File version error.	1	Device error.
2	Operating system version error.	2	Mounting failed.
3	Software version error.	3	No media.
4	Kernel version error.	4	Invalid media.
100	Upgrade device mounting failed.	5	File already existed.
101	Package is not found.	6	Not enough space.
102	Extracting package failed.	7	Creating temporary file failed.
103	LILO failed.	8	Opening disk failed.
104	Rebooting failed.	9	Formatting disk failed.
105	Invalid package.	10	Database has been changed.
300	Remote connection failed.	11	Appending failed.
301	Remote network error.	12	Bad sector.
302	Remote upgrade is not authorized.	13	No executable file.
303	Saving remote package failed.	14	Opening executable file failed.
304	Remote upgrade is cancelled by the user.	15	Writing executable file failed.
400	USB device mounting failed.	16	Creating image failed.
401	Reading upgrade package on the USB device failed.	19	Connecting device failed.
402	Copying upgrade package on the USB device failed.	20	Device is busy.
403	USB device is not connected.	21	Unsupported file system.
404	USB device is being used.	22	Verify failed.
405	Unsupported file system.		
500	System is busy clip copying.		

System Log Notices



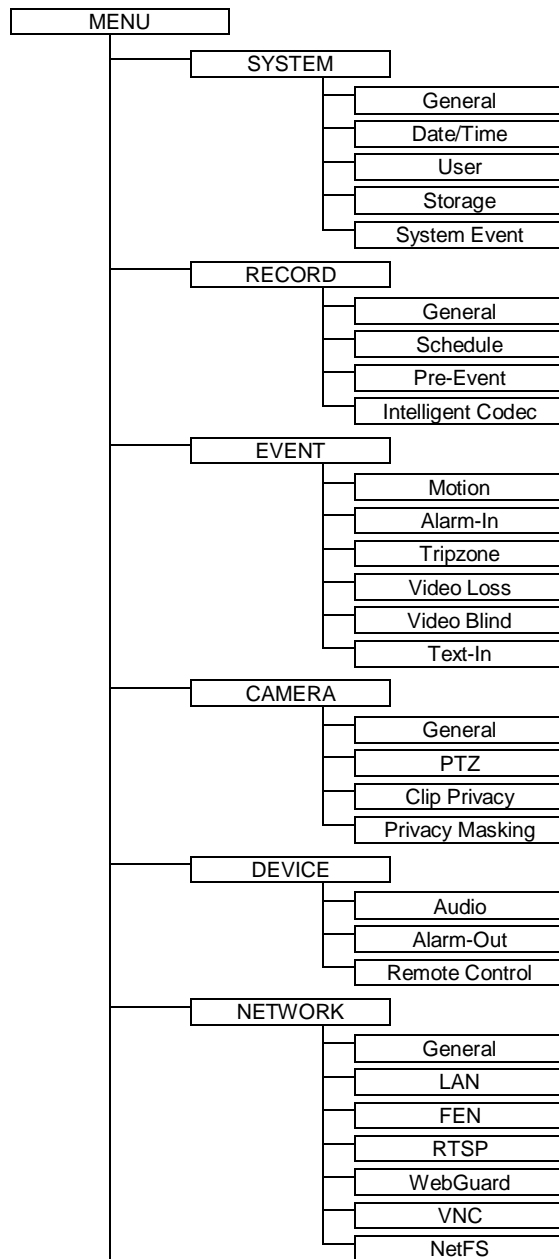

Boot Up	Clear All Data
Shutdown	Clear Disk
Restart	Format Disk
Upgrade	Disk Full
Upgrade Fail	Disk Config Change
Power Failure	No storage found
Time Change	Disk 'No.' : 'serial number'
Time Zone Change	Disk 'No.' : Removed
Time Sync	Auto Deletion
Time Sync Fail	Search Begin
Disk Bad	Search End
Login	Clip-Copy Begin
Logout	Clip-Copy End
Setup Begin	Clip-Copy Cancel
Setup End	Clip-Copy Fail
Remote Setup Change	Clip-Copy User:
Remote Setup Fail	Clip-Copy From:
Setup Imported	Clip-Copy To:
Setup Import Failure	Clip-Copy Duration of Video:
Setup Exported	Clip-Copy Camera:
Setup Export Failure	Callback Fail
Setup Export Cancel	Print Begin
Schedule On	Print End
Schedule Off	Print Cancel
Panic On	Factory Reset
Panic Off	Login : VNC (server address)
Connected : NetFS:	Logout : VNC (server address)
Disconnected : NetFS:	

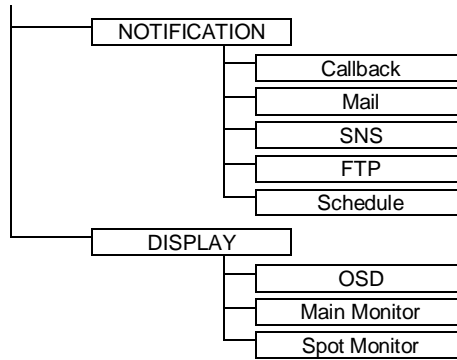
Map of Screens





Troubleshooting

Problem	Possible Solution
No Power	<ul style="list-style-type: none"> • Check power cord connections. • Confirm that there is power at the outlet.
No Live Video	<ul style="list-style-type: none"> • Check camera video cable and connections. • Check monitor video cable and connections. • Confirm that the camera has power. • Check camera lens settings. • Check the current main monitor resolution.
DVR has stopped recording	If hard disk drive is full, you will either need to delete video or set the DVR to the Overwrite Mode.
The icon  displays, however, the DVR is not recording.	When the DVR is in the Pre-Event recording mode, the yellow  and  display when there is no event, and the DVR is not recording. The red  and  display when any event occurs and the DVR starts recording.
While upgrading the system, the DVR keeps rebooting and the upgrade fails.	If the current system version is higher than the upgrade package file version, you should reset the DVR first using the Factory Reset. When using the Factory Reset, you will lose any settings you have saved.

Specifications

VIDEO	
Signal Format	NTSC, PAL or HD-TVI (Auto Detect)
Video Input	Composite 8 or 16 inputs: BNC, 1 Vp-p, auto-terminating, 75 Ohms
Monitor Outputs	HDMI: 1 HDMI VGA: 1 SPOT: 1 BNC, 1 Vp-p, 75 Ohms
Video Resolution	HDMI: 3840x2160, 1920x1080, 1440x900, 1280x1024 VGA: 1920x1080, 1440x900, 1280x1024 Composite (SPOT): 720x480 (NTSC), 720x576 (PAL)
Record Speed (images per second)	Real-time: 480ips @ Full HD
Playback Speed (images per second)	Full Duplex: 120ips @ Full HD

INPUTS/OUTPUTS	
Alarm Input	8 or 16 terminal, programmable as NC or NO, 2.4V (NC) or 0.3V (NO) threshold, 5VDC
Alarm Output	4 relay output, programmable as NC or NO, 2A@125VAC, 1A@30VDC (NO)
Alarm Reset Input	1 TTL, terminal block
Internal Buzzer	78dB at 10cm
Network Connectivity	10/100Mbps, 1Gbps Ethernet (RJ-45)
Audio Input	RCA Input: 4 Line In
Audio Output	RCA Output: 1, Line Out
Text Input	POS Interface, ATM Interface

CONNECTORS	
Video Input	Composite 8 or 16 BNC
Monitor Output	HDMI: 1 HDMI VGA: 1 VGA SPOT (Composite): 1 BNC
Audio In	4 RCA connector
Audio Out	1 RCA connector
Alarm Input/Output	Terminal Blocks
Ethernet Port	RJ-45
eSATA Port	eSATA
RS232 Serial Port	Two-connector terminal block
RS485 Serial Port	Two-connector terminal block
IR Port	1 Remote Control
USB Port	2 (USB 2.0)

STORAGE	
Primary Storage	SATA hard disk drive (up to 4)
Secondary Storage	eSATA hard disk drive (RAID) USB hard disk drive or flash drive

GENERAL	
Dimensions (W x H x D)	17" x 3.5" x 16.3" (430mm x 88mm x 415mm)
Unit Weight*	13 lbs. (5.9kg)
Shipping Weight*	19.4 lbs. (8.8kg)
Shipping Dimensions (W x H x D)	21.1" x 9.4" x 21.1" (535mm x 238mm x 535mm)
Operating Temperature	32°F to 104°F (0°C to 40°C)
Operating Humidity	0% to 90%
Power	100 to 240 V~, ≤ 2.0A, 50/60Hz
Power Consumption**	76W
Approvals	FCC, CE, UL, CB, PSE

* When two hard disk drives of 2TB are installed, the value was measured.

** When four hard disk drives of 3TB are installed, the value was measured.

Specifications are subject to change without notice.

COSTAR

COSTAR VIDEO SYSTEMS

101 Wrangler, Suite 201 Coppell, Texas 75019

Phone: (469) 635-6800

Fax: (469) 635-6822

Toll-free: (888) 694-7827