



Digital Video Recorder

Installation Manual

CR4025ET



	WARNING RISK OF ELECTRIC SHOCK DO NOT OPEN	
WARNING: TO REDUCE THE RISK OF ELECTRIC SHOCK, DO NOT REMOVE COVER (OR BACK). NO USER-SERVICEABLE PARTS INSIDE. REFER SERVICING TO QUALIFIED SERVICE PERSONNEL.		



The lightning flash with arrowhead symbol, within an equilateral triangle, is intended to alert the user to the presence of uninsulated "dangerous voltage" within the product's enclosure that may be of sufficient magnitude to constitute a risk of electric shock.



The exclamation point within an equilateral triangle is intended to alert the user to the presence of important operating and maintenance (servicing) instructions in the literature accompanying the appliance.

Symbol	Publication	Description
	IEC60417, No.5032	Alternating current
	IEC60417, No.5031	Direct current

COMPLIANCE NOTICE OF FCC:

THIS EQUIPMENT HAS BEEN TESTED AND FOUND TO COMPLY WITH THE LIMITS FOR A CLASS A DIGITAL DEVICE, PURSUANT TO PART 15 OF THE FCC RULES. THESE LIMITS ARE DESIGNED TO PROVIDE REASONABLE PROTECTION AGAINST HARMFUL INTERFERENCE WHEN THE EQUIPMENT IS OPERATED IN A COMMERCIAL ENVIRONMENT. THIS EQUIPMENT GENERATES, USES, AND CAN RADIATE RADIO FREQUENCY ENERGY AND IF NOT INSTALLED AND USED IN ACCORDANCE WITH THE INSTRUCTION MANUAL, MAY CAUSE HARMFUL INTERFERENCE TO RADIO COMMUNICATIONS. OPERATION OF THIS EQUIPMENT IN A RESIDENTIAL AREA IS LIKELY TO CAUSE HARMFUL INTERFERENCE, IN WHICH CASE USERS WILL BE REQUIRED TO CORRECT THE INTERFERENCE AT THEIR OWN EXPENSE.

WARNING: CHANGES OR MODIFICATIONS NOT EXPRESSLY APPROVED BY THE PARTY RESPONSIBLE FOR COMPLIANCE COULD VOID THE USER'S AUTHORITY TO OPERATE THE EQUIPMENT.

THIS CLASS OF DIGITAL APPARATUS MEETS ALL REQUIREMENTS OF THE CANADIAN INTERFERENCE-CAUSING EQUIPMENT REGULATIONS.

The information in this manual is believed to be accurate as of the date of publication even though explanation about some functions may not be incorporated. We are not responsible for any problems resulting from the use thereof. The information contained herein is subject to change without notice. Revisions or new editions to this publication may be issued to incorporate such changes.

The software included in this product contains some Open Sources. You may obtain the corresponding source code which we have to distribute according to the license policy. Go to System Setup - About page for more information. This product includes software developed by the University of California, Berkeley and its contributors, and software developed by the OpenSSL Project for use in the OpenSSL Toolkit (<http://www.openssl.org/>). Also, this product includes cryptographic software written by Eric Young (ey@cryptsoft.com), and software written by Tim Hudson (tjh@cryptsoft.com).

Important Safeguards

<p>1. Read Instructions All the safety and operating instructions should be read before the appliance is operated.</p> <p>2. Retain Instructions The safety and operating instructions should be retained for future reference.</p> <p>3. Cleaning Unplug this equipment from the wall outlet before cleaning it. Do not use liquid aerosol cleaners. Use a damp soft cloth for cleaning.</p> <p>4. Attachments Never add any attachments and/or equipment without the approval of the manufacturer as such additions may result in the risk of fire, electric shock or other personal injury.</p> <p>5. Water and/or Moisture Do not use this equipment near water or in contact with water.</p> <p>6. Placement and Accessories Do not place this equipment on an unstable cart, stand or table. The equipment may fall, causing serious injury to a child or adult, and serious damage to the equipment. This equipment and cart combination should be moved with care. Quick stops, excessive force, and uneven surfaces may cause the equipment and cart combination to overturn. Do not place this equipment on a closed space. Sufficient amount of ventilation air is necessary to avoid increase of ambient temperature which can cause improper operation or the risk of fire.</p> <p>7. Power Sources This equipment should be operated only from the type of power source indicated on the marking label. If you are not sure of the type of power, please consult your equipment dealer or local power company. You may want to install a UPS (Uninterruptible Power Supply) system for safe operation in order to prevent damage caused by an unexpected power stoppage. Any questions concerning UPS, consult your UPS retailer. This equipment should be remain readily operable.</p> <p>8. Power Cords Operator or installer must remove power and TNT connections before handling the equipment.</p> <p>9. Lightning For added protection for this equipment during a lightning storm, or when it is left unattended and unused for long periods of time, unplug it from the wall outlet and disconnect the antenna or cable system. This will prevent damage to the equipment due to lightning and power-line surges.</p>	<p>10. Overloading Do not overload wall outlets and extension cords as this can result in the risk of fire or electric shock.</p> <p>11. Objects and Liquids Never push objects of any kind through openings of this equipment as they may touch dangerous voltage points or short out parts that could result in a fire or electric shock. Never spill liquid of any kind on the equipment.</p> <p>12. Servicing Do not attempt to service this equipment yourself. Refer all servicing to qualified service personnel.</p> <p>13. Damage requiring Service Unplug this equipment from the wall outlet and refer servicing to qualified service personnel under the following conditions: A. When the power-supply cord or the plug has been damaged. B. If liquid is spilled, or objects have fallen into the equipment. C. If the equipment has been exposed to rain or water. D. If the equipment does not operate normally by following the operating instructions, adjust only those controls that are covered by the operating instructions as an improper adjustment of other controls may result in damage and will often require extensive work by a qualified technician to restore the equipment to its normal operation. E. If the equipment has been dropped, or the cabinet damaged. F. When the equipment exhibits a distinct change in performance – this indicates a need for service.</p> <p>14. Replacement Parts When replacement parts are required, be sure the service technician has used replacement parts specified by the manufacturer or that have the same characteristics as the original part. Unauthorized substitutions may result in fire, electric shock or other hazards.</p> <p>15. Safety Check Upon completion of any service or repairs to this equipment, ask the service technician to perform safety checks to determine that the equipment is in proper operating condition.</p> <p>16. Field Installation This installation should be made by a qualified service person and should conform to all local codes.</p> <p>17. Correct Batteries Warning: Risk of explosion if battery is replaced by an incorrect type. Replace only with the same or equivalent type. Dispose of used batteries according to the instructions. The battery shall not be exposed to excessive heat such as sunshine, fire or the like.</p> <p>18. Tmra A manufacturer's maximum recommended ambient temperature (Tmra) for the equipment must be specified so that the customer and installer may determine a suitable maximum operating environment for the equipment.</p>
---	---



WEEE (Waste Electrical & Electronic Equipment)

Correct Disposal of This Product

(Applicable in the European Union and other European countries with separate collection systems)



This marking shown on the product or its literature, indicates that it should not be disposed with other household wastes at the end of its working life. To prevent possible harm to the environment or human health from uncontrolled waste disposal, please separate this from other types of wastes and recycle it responsibly to promote the sustainable reuse of material resources.

Household users should contact either the retailer where they purchased this product, or their local government office, for details of where and how they can take this item for environmentally safe recycling.

Business users should contact their supplier and check the terms and conditions of the purchase contract. This product should not be mixed with other commercial wastes for disposal.

Table of Contents

Chapter 1 — Introduction	1
Feature	1
Technical Overview	2
Chapter 2 — Installation	3
Package Contents	3
Required Installation Tools	3
Video Input	3
Audio In/Out	4
Alarm Input/Output	4
Factory Reset Switch	4
Video Out	5
Network Port	5
RS232 Port	5
RS485 Port	5
Power Cord Connector	6
Chapter 3 — Configuration	7
Front Panel Controls	7
Camera Buttons	7
HDD LED	7
Alarm LED	7
Arrow Buttons	8
Play/Pause Button	8
MENU Button	8
PTZ/Zoom Button	8
Group/Sequence Button	8
Search Button	9
Display Button	9
Panic Button	9
USB Port	9
Remote Control Buttons (Optional)	10
ID Button	10
Camera Buttons	10
Sequence Button	10
Freeze Button	10
Arrow Buttons	11
Menu Button	11
Playback Buttons	11
Panic Button	11
Layout Button	11
Zoom Button	11
PTZ Button	11
Enter Button	11
Alarm Button	12
PTZ Control Buttons	12
Back Up Button	12
Calendar Button	12

Appendix 13
 Error Code Notices 13
 System Log Notices 14
 Map of Screens 15
 Troubleshooting 16
 Specifications 17

Chapter 1 — Introduction

Feature

Your color digital video recorder (DVR) provides recording capabilities for 4 camera inputs. It provides exceptional picture quality in both live and playback modes, and offers the following features:

- Live Monitoring for Each Channel
- Compatible with Color (NTSC or PAL) and B&W (CCIR and EIA-170) Video Sources
- Auto Detection for HD-TVI and AHD Input
- Auto Detection for NTSC and PAL
- H.264 Codec
- Simultaneous Outputs: 1 HDMI, 1 VGA
- UTC for Camera Menu Control via Coax Cable
- Multiple Search Engines (Date/Time, Calendar, Record Table, Event)
- Real-time Recording (120 Images per Second with Very High (Full HD) Resolution)
- Continuous Recording in Disk Overwrite Mode
- 2 USB 2.0 Ports
- Continues Recording while Transmitting to Remote Site and during Playback
- User-friendly Graphical User Interface (GUI) Menu System
- Multiple Recording Modes (Time-lapse, Pre-event, Alarm, Motion and Panic)
- Two-way Audio Communication
- 4-Channel Audio Recording and 1-Channel Audio Playback
- Text Input for ATM and POS
- Alarm Connections Include: Input, Output
- Built-in Alarm Buzzer
- Live or Recorded Video Access via Ethernet
- Time Synchronization using industry standard protocol
- IR Remote Control (Optional)
- Self-diagnostics with automatic notification including hard disk drive S.M.A.R.T. protocol

Technical Overview

In addition to replacing both a time-lapse VCR and a multiplexer in a security installation, your DVR has many features that make it much more powerful and easier to use than even the most advanced VCR.

The DVR converts analog NTSC or PAL video to digital images and records them on a hard disk drive. Using a hard disk drive allows you to access recorded video almost instantaneously; there is no need to rewind tape. The technology also allows you to view recorded video while the DVR continues recording video.

Digitally recorded video has several advantages over analog video recorded on tape. There is no need to adjust tracking. You can freeze frames, fast forward, fast reverse, slow forward and slow reverse without image streaking or tearing. Digital video can be indexed by time or events, and you can instantly view video after selecting the time or event.

Your DVR can be set up for event or time-lapse recording. You can define times to record, and the schedule can change for different days of the week and user defined holidays.

The DVR can be set up to alert you when the hard disk drive is full, or it can be set to record over the oldest video once the disk is full.

Your DVR uses a proprietary encryption scheme making it nearly impossible to alter video.

You can view video and control your DVR remotely by connecting via Ethernet. There are two USB ports that can be used to upgrade the system or copy video clips to external hard disk and flash drives.

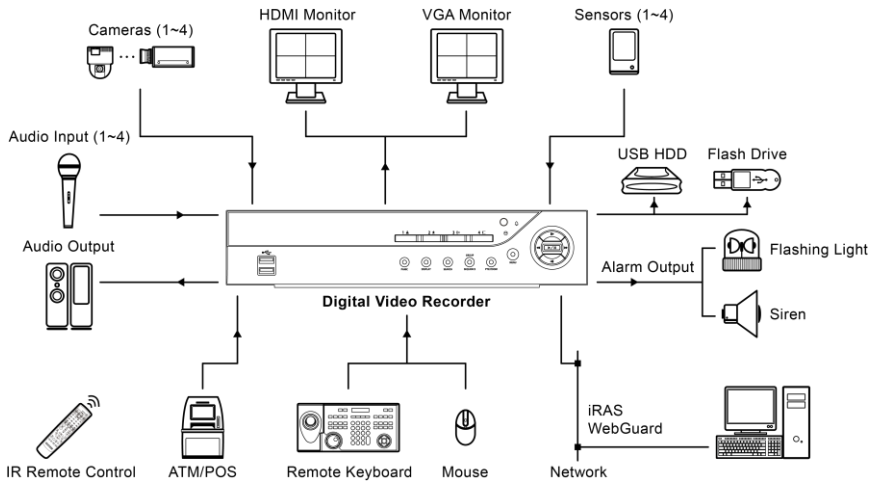

Figure 1: Typical DVR installation.

Chapter 2 — Installation

Package Contents

The package contains the following:

- Digital Video Recorder
- Power Adaptor and Power Cord
- User's Manual (This Document)
- USB Mouse
- IR Remote Control (Optional)

Required Installation Tools

No special tools are required to install the DVR. Refer to the installation manuals for the other items that make up part of your system.

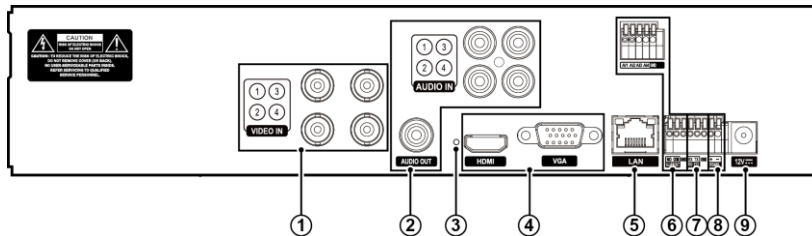

Figure 2: DVR rear panel.

- | | | | |
|------------------------|----------------------|------------------------|--------------|
| ① Video Input | ② Audio In/Out | ③ Factory Reset Switch | ④ Video Out |
| ⑤ Network Port | ⑥ Alarm Input/Output | ⑦ RS232 Port | ⑧ RS485 Port |
| ⑨ Power Cord Connector | | | |

Your DVR can be used with either NTSC or PAL equipment.

NOTE: You cannot mix NTSC and PAL equipment. For example you cannot use a PAL camera and an NTSC monitor.

Video Input

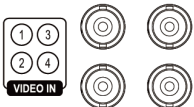

Connect the coaxial cables from the video sources to the BNC Video In connectors.

Audio In/Out

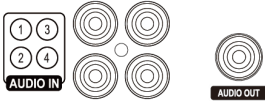

Your DVR can record audio from up to four sources. Connect the audio sources to Audio In 1, Audio In 2, Audio In 3 and Audio In 4 as needed using RCA jacks. Connect Audio Out to your amplifier.

NOTE: It is the user's responsibility to determine if local laws and regulations permit recording audio.

The DVR does not have amplified audio output, so you will need a speaker with an amplifier. The DVR does not have a pre-amplifier for audio input, so the audio input should be from an amplified source, not directly from a microphone.

Alarm Input/Output

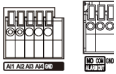

NOTE: To make connections on the Alarm Connector Strip, press and hold the button and insert the wire in the hole below the button. After releasing the button, tug gently on the wire to make certain it is connected. To disconnect a wire, press and hold the button above the wire and pull out the wire.

AI 1 to 4 (Alarm-In): You can use external devices to signal the DVR to react to events. Mechanical or electrical switches can be wired to the AI (Alarm-In) and GND (Ground) connectors. The threshold voltage of electrical switches for NC (Normally Closed) is above 2.4V and for NO (Normally Open) is below 0.3V, and should be stable at least 0.5 seconds to be detected. The voltage range of alarm input is from 0V to 5V.

GND (Ground): Connect the ground side of the Alarm input and/or alarm output to the GND connector.

NOTE: All the connectors marked GND are common.

NO (Normally Open): Connect the device to the COM and NO (Normally Open) connector. NO is a relay output which sinks 2A@125VAC and 1A@30VDC.

Connector Pin Outs:

AI (1 to 4)	Alarm Inputs 1 to 4
GND	Chassis Ground
COM	Relay Common
NO	Relay Alarm Out (Normally Open)

Factory Reset Switch



The DVR has a Factory Reset switch to the left of the HDMI connector on the rear panel. This switch will only be used on the rare occasions that you want to return all the settings to the original factory settings.

CAUTION: When using the *Factory Reset*, you will lose any settings you have saved.

To reset the unit, you will need a straightened paperclip:

1. Turn the DVR off.
2. Turn it on again.
3. While the DVR is initializing, the front panel LEDs will blink. When the front panel LEDs blink, poke the straightened paperclip into the unlabeled hole to the left of the HDMI connector.
4. Hold the reset switch until the DVR's internal buzzer sounds twice.
5. Release the reset switch. All of the DVR's settings are now at the original settings it had when it left the factory.

Video Out

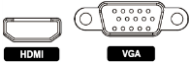

An HDMI (High-Definition Multimedia Interface) connector is provided so that you can use an HDMI monitor as your main monitor.

A VGA connector is provided so that you can use a standard, multi-sync computer monitor as your main monitor. Use the cable supplied with your monitor to connect it to the DVR.

NOTE: Connect the monitor before the DVR boots so that video can be displayed on the monitor with the resolution you have set during system setup. If you want to use both the HDMI and VGA Monitor connectors, one of the monitors should be connected before the DVR boots, and the other monitor should be connected after the DVR boots.

Network Port



The DVR can be networked using the 10Mb/100Mb Ethernet connector. Connect a Cat5e cable with an RJ-45 jack to the DVR connector. The DVR can be networked with a computer for remote monitoring, searching, configuration and software upgrades.

CAUTION: The network connector is not designed to be connected directly with cable or wire intended for outdoor use.

RS232 Port



An RS232 port is provided to connect remote control devices such as a control keyboard. PTZ cameras or text-in devices can also be connected to the RS232 port.

Connector Pin Outs:

Master Unit		Slave Unit	
RX	→ To	→	TXD
TX	→ To	→	RXD
GND	→ To	→	GND

NOTE: Refer to the following for pin-out details for the 9-pin connector of the slave unit.

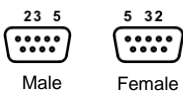

Pin 2	RXD (Receive Data)
Pin 3	TXD (Transmit Data)
Pin 5	GND (Ground)

RS485 Port



The DVR can be controlled remotely by an external device or control system, such as a control keyboard, using RS485 half-duplex serial communications signals. The RS485 connector can also be used to control PTZ (pan, tilt, zoom) cameras. Connect RX+/TX+ and RX-/TX- of the control system to the + and - (respectively) of the DVR.

Connector Pin Outs:

Master Unit		Slave Unit	
+	→ To	→	TX+/RX+
-	→ To	→	TX-/RX-

Power Cord Connector



Connect the connector of the adaptor to the DVR, and connect the AC power cord to the adaptor and then to the wall outlet.

WARNING: ROUTE POWER CORDS SO THAT THEY ARE NOT A TRIPPING HAZARD. MAKE CERTAIN THE POWER CORD WILL NOT BE PINCHED OR ABRADED BY FURNITURE. DO NOT INSTALL POWER CORDS UNDER RUGS OR CARPET. THE POWER CORD HAS A GROUNDING PIN. IF YOUR POWER OUTLET DOES NOT HAVE A GROUNDING PIN RECEPTACLE, DO NOT MODIFY THE PLUG. DO NOT OVERLOAD THE CIRCUIT BY PLUGGING TOO MANY DEVICES IN TO ONE CIRCUIT.

Your DVR is now ready to operate.

Chapter 3 — Configuration

NOTE: Your DVR should be completely installed before proceeding. Refer to *Chapter 2 — Installation*.

Front Panel Controls

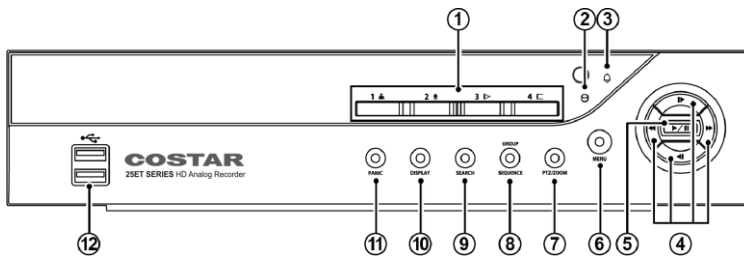

Figure 3: DVR front panel.

- | | | | |
|---------------------|------------------|-------------------|-------------------------|
| ① Camera Buttons | ② HDD LED | ③ Alarm LED | ④ Arrow Buttons |
| ⑤ Play/Pause Button | ⑥ Menu Button | ⑦ PTZ/Zoom Button | ⑧ Group/Sequence Button |
| ⑨ Search Button | ⑩ Display Button | ⑪ Panic Button | ⑫ USB Port |

The front panel looks and operates much like a VCR combined with a multiplexer. Many of the buttons have multiple functions. The buttons on the infrared remote control, while laid out differently, perform the same functions as those on the front panel. The following describes each button and control. Take a few minutes to review the descriptions. You will use these to initially set up your DVR and for daily operations.

NOTE: A separate Alarm button on the front panel is not provided. Pressing any button on the front panel resets alarm output including the internal buzzer when the alarm is activated. However, when you are in the menu or PTZ mode, you have to exit the menu or PTZ mode first to reset alarm output.

The infrared sensor on the DVR is just to the right of the arrow buttons. Make certain that nothing blocks the sensor, or the remote control will not function properly.

When you use wireless communication devices (such as Wi-Fi or Bluetooth) near the DVR, the remote control might not function properly.

You can also use a USB mouse (not supplied) to navigate through the screens and menus much like you would on a computer.

Camera Buttons

Pressing the individual camera buttons will cause the selected camera to display full screen.

In the PTZ mode, pressing the button 1 zooms in the screen and the button 2 zooms out the screen, pressing the button 3 focuses near and button 4 focuses far.

HDD LED

The HDD LED flickers when the DVR is recording or searching video on the hard disk drive.

















Alarm LED

The Alarm LED is lit when alarm output or internal buzzer is activated.



Arrow Buttons

These buttons are used to navigate through menus and GUI. You can also use them to change numbers by highlighting a number in the menu and using the Up and Down arrow buttons to increase or decrease the number's value.

These buttons are also used to control Pan and Tilt when in the PTZ mode.

In the playback mode, pressing the  button plays video backward at high speed. Pressing the button again toggles the playback speed from ,  and  (X16, X32, X64, X128, X256). The screen displays ,  and  respectively. Pressing the  button plays video forward at high speed. Pressing the button again toggles the playback speed from ,  and  (X16, X32, X64, X128, X256). The screen displays ,  and  respectively. When in the pause mode, pressing the  button moves to the next image and pressing the  button moves to the previous image.

Play/Pause Button

In the live monitoring mode, pressing the  button freezes the current screen and the screen displays  icon. When in the playback mode, pressing the  button plays back images at regular speed or pauses playing video.

Pressing the  button selects a highlighted item or completes an entry that you have made during system setup.



The LED around the  button is lit when the unit is On.

MENU Button

In the Live Monitoring mode and Search mode, pressing the  button displays the menu icons on the right edge of the screen. Pressing the button again hides the menu icons. During menu setup, pressing the button closes the current menu or setup dialog box.

Pressing and holding the  button for three seconds or longer enters the cameo mode and allows you to change the screen layout. Refer to the following *Live Monitoring – Active Cameo Mode* section for details.

PTZ/Zoom Button

Pressing the  button zooms in the current image in double on the screen. You can use the arrow buttons to move the rectangle to another area. Pressing the  (Play/Pause) button zooms in the image in rectangle.

Pressing and holding the button for three seconds or longer enters the PTZ (Pan/Tilt/Zoom) mode and the PTZ icon flickers. Pressing the button again exits the PTZ mode. Pressing the arrow buttons or  button allows you to control properly configured cameras.

Group/Sequence Button

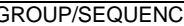
When in the live mode, pressing the  button changes the screen from the current camera group to the next camera group, and the screen displays the page number. Pressing and holding the button for three seconds or longer displays live channels sequentially.

Search Button

Pressing the **SEARCH** button enters the search mode, and pressing the button again exits the search mode. When entering the search mode, video is paused. Pressing the **▶/||** (Play/Pause) button plays back video at regular speed. The screen displays **||** when the DVR is in the Pause mode and the screen displays **▶** when the DVR is playing back video.

In the Search mode, pressing and holding the **SEARCH** button for three seconds or longer allows you to copy video clips.

Display Button

Pressing the **DISPLAY** button toggles between different display formats. The available formats are: Single screen and 2x2.

Panic Button

Pressing the **PANIC** button starts panic recording of all camera channels, and displays **!** on the screen. Pressing the button again will stop panic recording.

USB Port

Two USB ports on the front panel are provided to connect external hard disk or flash drives for video clip copying or system upgrades. Position external drives close enough to the DVR so that you can make the cable connections, usually less than 6 feet. Use the USB cable provided with the hard disk drive to connect it to the DVR.

A USB mouse (not supplied) can be connected to one of the ports. You can use the mouse to navigate through the screens and menus much like you would on a computer.

A PostScript™ USB printer (not supplied) can be connected to one of the ports. You can print selected images resulting from a search.

A USB to Serial converter can be connected to the USB port. Multiple text-in devices can be used with a USB to Serial converter.

Remote Control Buttons (Optional)

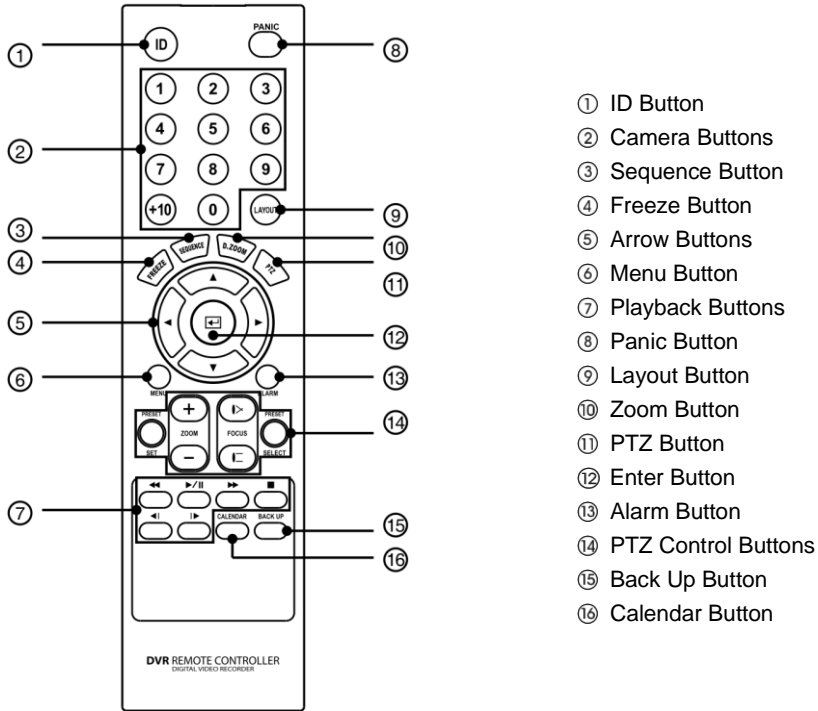

Figure 4: Infrared remote control.

NOTE: For simplicity, the button descriptions in this manual refer to the front panel buttons.

ID Button

If a DVR System ID is set to 0, the infrared remote control will control that DVR without any additional operations. (Refer to the *System – General* setup screen in this chapter for further information on setting the System ID.) If the system ID is 1 to 16, you must to press the **ID** button and then press the number button (1 to 16 (+10 & 6)) in order to control that DVR. If the System ID of two or more DVRs is set to 0, those DVRs will react to the infrared remote control at the same time.

Camera Buttons

Pressing the individual camera buttons will cause the selected camera to display full screen. Buttons 1 to 9 are also used to enter passwords.

Sequence Button

When in the Live Monitoring mode, pressing the **SEQUENCE** button displays live channels sequentially.

Freeze Button

Pressing the **FREEZE** button freezes the current live screen.

Arrow Buttons

These buttons are used to navigate through menus and GUI. You can also use them to change numbers by highlighting a number in the menu and using the Up and Down arrow buttons to increase or decrease the number's value. These buttons are also used to control Pan and Tilt when in the PTZ mode.

Pressing the Left and Right buttons moves through screen pages in the Live Monitoring mode and Search mode.

Menu Button

In the Live Monitoring mode and Search mode, pressing the **MENU** button displays the menu icons on the right edge of the screen. Pressing the button also hides the menu icons. During menu setup, pressing the button closes the current menu or setup dialog box.

Playback Buttons

- **Rewind:** Pressing the **◀◀** button plays video backward at high speed. Pressing the button again toggles the playback speed from **◀**, **◀◀** and **◀◀◀** (X16, X32, X64, X128, X256).
- **Play/Pause:** Pressing the **⏮** button plays back video at regular speed and pressing the button again pauses video. The screen displays **||** when the DVR is in the Pause mode and the screen displays **▶** when the DVR is playing back video.
- **Fast Forward:** Pressing the **▶▶** button plays video forward at high speed. Pressing the button again toggles the playback speed from **▶**, **▶▶** and **▶▶▶** (X16, X32, X64, X128, X256).
- **Stop:** Pressing the **■** button stops playback and enters the Live Monitoring mode.
- **Backward:** When in the pause mode, pressing the **◀|** button moves to the previous image.
- **Forward:** When in the pause mode, pressing the **|▶** button moves to the next image.

In the Live Monitoring mode, pressing any playback button enters to the Search mode.

Panic Button

Pressing the **PANIC** button starts panic recoding of all camera channels, and displays **!** on the screen. Pressing the button again will stop panic recording.

Layout Button

Pressing the **LAYOUT** button toggles between different display formats. The available formats are: 2x2 and single screen.

Zoom Button

Pressing the **ZOOM** button zooms the current image on the screen. A PIP with a rectangle temporarily displays showing what area of the screen has been enlarged. You can use the arrow buttons to move the rectangle to another area.

PTZ Button

Pressing the **PTZ** button enters the PTZ (Pan/Tilt/Zoom) mode which allows you to control properly configured cameras.

Enter Button

The **↵** (Enter) button selects a highlighted item or completes an entry that you have made during system setup.

Alarm Button

Pressing the **ALARM** button resets the DVR's outputs including the internal buzzer during an alarm.

PTZ Control Buttons

While in the PTZ mode, the **PRESET** buttons are used to save Presets and load a Preset View, the **ZOOM** buttons are used to Zoom In and Zoom Out, and the **FOCUS** buttons are used for Near Focus and Far Focus.

Back Up Button

Pressing the **BACK UP** button allows you to copy video clips.

Calendar Button

In the search mode, pressing the **CALENDAR** button displays the Calendar Search screen.

Appendix

Error Code Notices

System Upgrade Related		Clip Copy Related	
No.	Description	No.	Description
0	Unknown error.	0	Unknown error.
1	File version error.	1	Device error.
2	Operating system version error.	2	Mounting failed.
3	Software version error.	3	No media.
4	Kernel version error.	4	Invalid media.
100	Upgrade device mounting failed.	5	File already existed.
101	Package is not found.	6	Not enough space.
102	Extracting package failed.	7	Creating temporary file failed.
103	LILO failed.	8	Opening disk failed.
104	Rebooting failed.	9	Formatting disk failed.
105	Invalid package.	10	Database has been changed.
300	Remote connection failed.	11	Appending failed.
301	Remote network error.	12	Bad sector.
302	Remote upgrade is not authorized.	13	No executable file.
303	Saving remote package failed.	14	Opening executable file failed.
304	Remote upgrade is cancelled by the user.	15	Writing executable file failed.
400	USB device mounting failed.	16	Creating image failed.
401	Reading upgrade package on the USB device failed.	19	Connecting device failed.
402	Copying upgrade package on the USB device failed.	20	Device is busy.
System Upgrade Related		Clip Copy Related	
No.	Description	No.	Description
403	USB device is not connected.	21	Unsupported file system.
404	USB device is being used.	22	Verify failed.
405	Unsupported file system.		
500	System is busy clip copying.		

System Log Notices



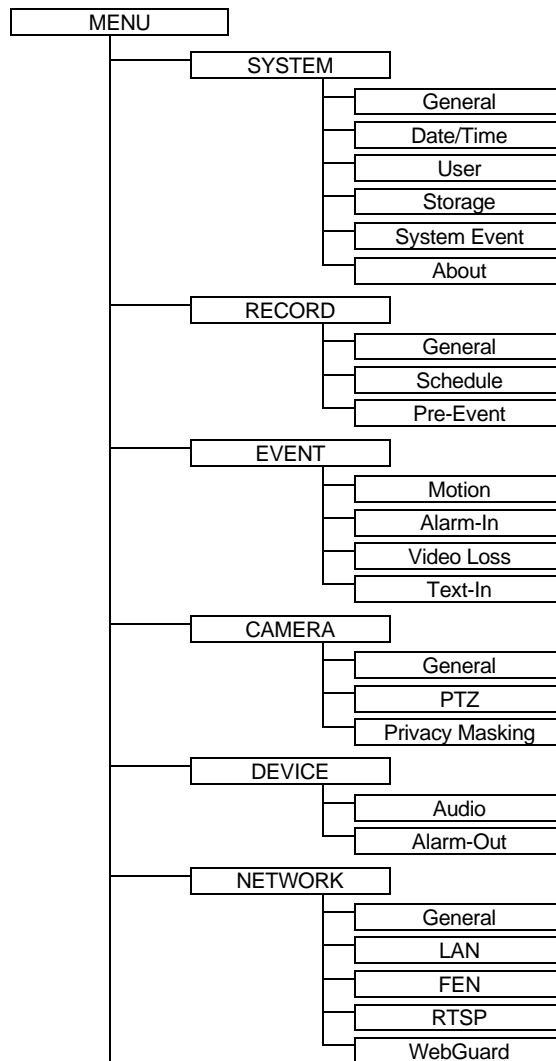

Boot Up	Clear All Data
Shutdown	Clear Disk
Restart	Format Disk
Upgrade: previous version x.x.x	Disk Full
Upgrade Fail	Disk Config Change
Power Failure	No storage found
Time Change	Disk 'No.' : 'serial number'
Time Zone Change	Disk 'No.' : Removed
Time Sync	Auto Deletion
Time Sync Fail	Search Begin
Disk Bad	Search End
Login	Clip-Copy Begin
Logout	Clip-Copy End
Setup Begin	Clip-Copy Cancel
Setup End	Clip-Copy Fail
Remote Setup Change	Clip-Copy User:
Remote Setup Fail	Clip-Copy From:
Setup Imported	Clip-Copy To:
Setup Import Failure	Clip-Copy Duration of Video:
Setup Exported	Clip-Copy Camera:
Setup Export Failure	Callback Fail
Setup Export Cancel	Print Begin
Schedule On	Print End
Schedule Off	Print Cancel
Panic On	Factory Reset
Panic Off	Login : VNC (server address)
Connected : NetFS:	Logout : VNC (server address)
Disconnected : NetFS:	

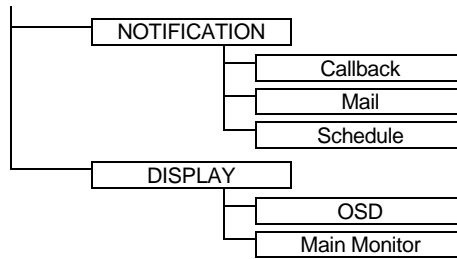
Map of Screens





Troubleshooting

Problem	Possible Solution
No Power	<ul style="list-style-type: none"> • Check power cord connections. • Confirm that there is power at the outlet.
No Live Video	<ul style="list-style-type: none"> • Check camera video cable and connections. • Check monitor video cable and connections. • Confirm that the camera has power. • Check camera lens settings. • Check the current main monitor resolution.
DVR has stopped recording	If hard disk drive is full, you will either need to delete video or set the DVR to the Overwrite Mode.
The icon  displays, however, the DVR is not recording.	When the DVR is in the Pre-Event recording mode, the yellow  and  display when there is no event, and the DVR is not recording. The red  and  display when any event occurs and the DVR starts recording.
While upgrading the system, the DVR keeps rebooting and the upgrade fails.	If the current system version is higher than the upgrade package file version, you should reset the DVR first using the Factory Reset. When using the Factory Reset, you will lose any settings you have saved.

Specifications

VIDEO	
Signal Format	NTSC or PAL (Auto Detect)
Video Input	Composite/HD-TVI/AHD: 4 inputs, 1 Vp-p, auto-terminating, 75 Ohms
Monitor Outputs	HDMI: 1, VGA: 1
Video Resolution	HDMI: 3840x2160, 1920x1080, 1280x1024 VGA: 1920x1080, 1280x1024
Record Speed (images per second)	Real-time: 120 ips @ Full HD
Playback Speed (images per second)	Full Duplex: 120 ips @ Full HD

INPUTS/OUTPUTS	
Alarm Input	4 terminal, programmable as NC or NO, 2.4V (NC) or 0.3V (NO) threshold, 5VDC
Alarm Output	1 relay output, terminal blocks, 2A@125VAC, 1A@30VDC (NO)
Internal Buzzer	78dB at 10cm
Network Connectivity	10/100Mbps Ethernet (RJ-45)
Audio Input	RCA Input: 4 Line In
Audio Output	RCA Output: 1, Line Out
Text Input	POS Interface, ATM Interface

CONNECTORS	
Video Input	Composite/HD-TVI/AHD: 4 BNC
Monitor Output	HDMI: 1, VGA: 1
Audio In	4 RCA connector
Audio Out	1 RCA connector
Alarm Input/Output	Terminal Blocks
Ethernet Port	RJ-45
RS232 Serial Port	Two-connector terminal block
RS485 Serial Port	Two-connector terminal block
IR Port	1 Remote Control
USB Port	2 (USB 2.0)

STORAGE	
Primary Storage	SATA hard disk drive
Secondary Storage	USB hard disk drive or flash drive

GENERAL	
Dimensions (W x H x D)	11.8" x 2.6" x 9.6" (300mm x 67mm x 245mm)
Unit Weight	6.61 lbs. (3.0kg) with 2TB 2HDDs
Operating Temperature	32°F to 104°F (0°C to 40°C)
Operating Humidity	0% to 90%
Power Input	ADAPTER (INPUT: 100-240V~, 50/60Hz, 1.5A / OUTPUT 12V $\overline{\text{DC}}$, 5A)
Power Consumption	12V $\overline{\text{DC}}$, 1.7A, 20.4W (6TB 2HDDs)
Approvals	FCC

Specifications are subject to change without notice.

COSTAR
COSTAR VIDEO SYSTEMS

101 Wrangler Drive, Suite 201 Coppel, Texas 75019

Phone: (469) 635-6800 Fax: (469) 635-6822

Toll-free: (888) 694-7827